

# Sigma2D

## Tutorial para criação e análise de resultados de um modelo de placa simples.

Novembro 2015

<http://www.tecgraf.puc-rio.br/mvgeo>

Este arquivo: CursoMVG-02-ModeloSimples

Modelo: ModeloSimples

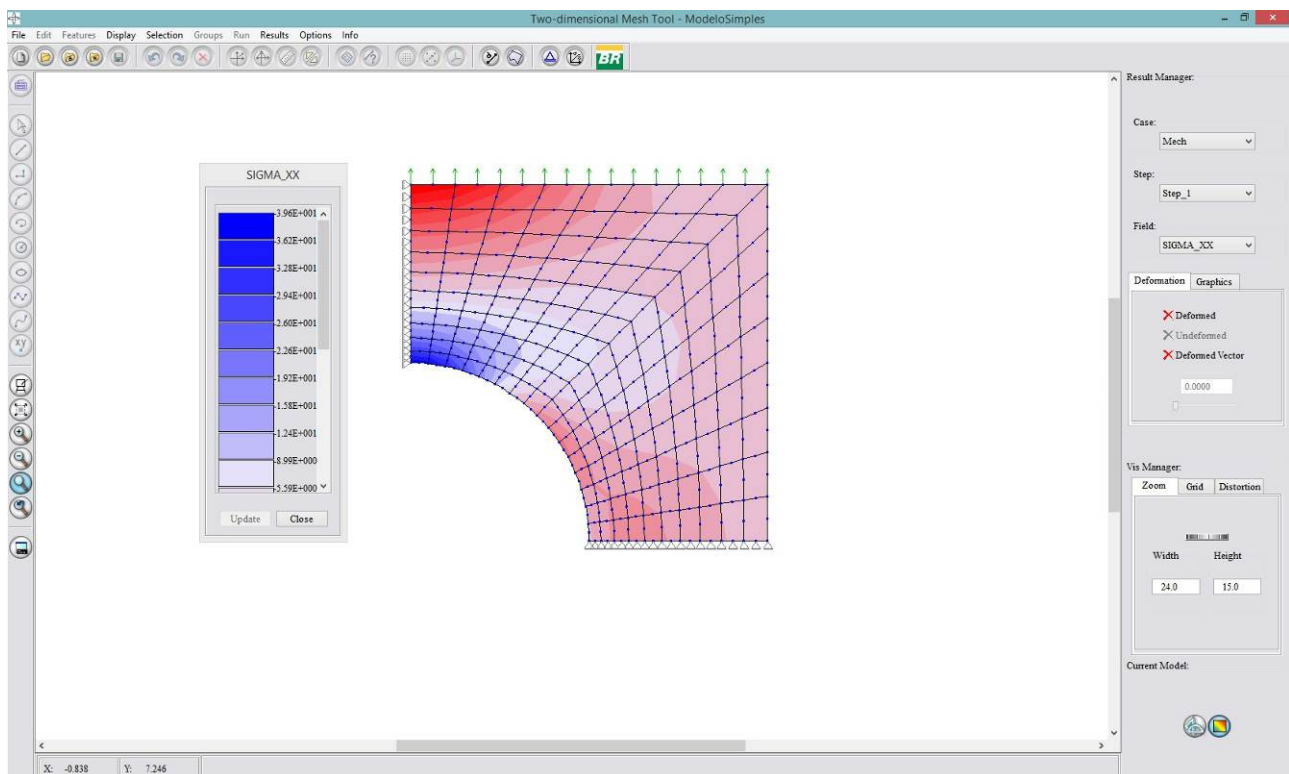



## Tabela de Conteúdo

Ativa o grid de coordenadas.....	3
Botão de inserção de linha .....	3
Inserir linha.....	4
Inserção das linhas do modelo .....	5
Botão de inserção de arco.....	6
Inserção de arco no modelo.....	6
Inserção de segundo arco no modelo .....	7
Criação de região após encontro de arco e linha .....	8
Salvar projeto com um nome (comando "Save Project As... ").....	9
Salvar projeto com um nome (comando "Save Project As... ").....	9
Criar linha que divide a região .....	10
Região dividida automaticamente .....	11
Subdividir curvas .....	12
Aplicar subdivisão de curvas.....	13
Aplicar subdivisão nas outras curvas do modelo .....	13
Procedimento para criar malha.....	14
Aplicação de malha bilinear quadrática .....	14
Aplicação da malha na segunda parte da região.....	15
Salvar modelo com a malha criada.....	15
Seleção de restrições de deslocamento.....	16
Aplicar restrições de deslocamento ao modelo .....	17
Aplicar de restrições de deslocamento ao modelo .....	18
Seleção de atributo de carregamento uniforme .....	19
Aplicar atributo de carregamento uniforme .....	20
Seleção de atributo de material .....	21
Aplicar atributo de material ao modelo.....	22
Selecionar atributos de tipo de análise .....	23
Aplicar atributos de tipo de análise .....	24
Selecionar atributos de tipos de elemento .....	25
Aplicar atributos de tipos de elemento ao modelo .....	26
Converter modelo geométrico para malha de elementos finitos .....	27
Rodar análise .....	28
Informações do modelo.....	29
Escolha dos passos de execução Titulo 2.....	29
Salvar Resultados .....	30
Salvar Resultado.....	31
Primeiro resultado .....	32
Habilitar exibição de nós do modelo .....	32
Modelo final.....	33



## Ativa o grid de coordenadas

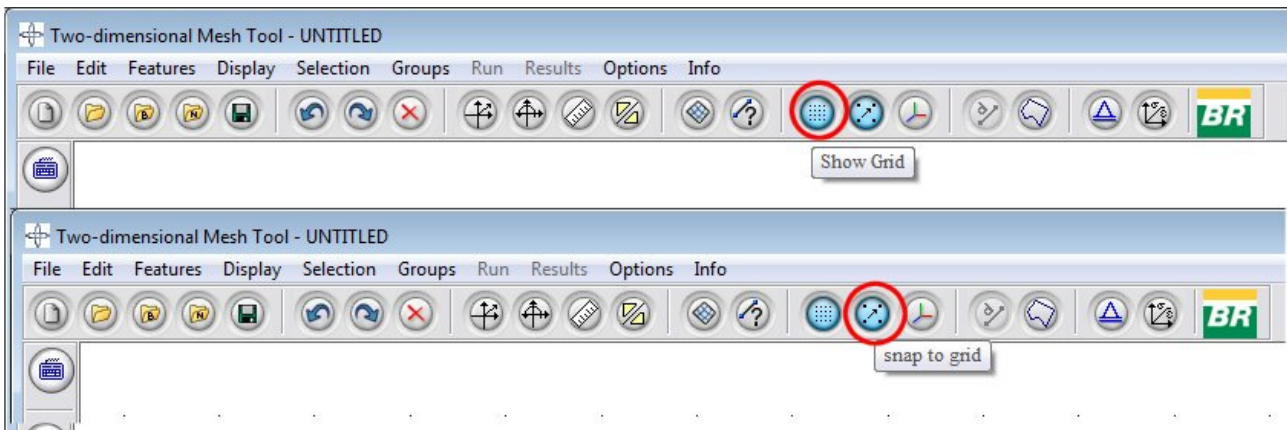

## Botão de inserção de linha

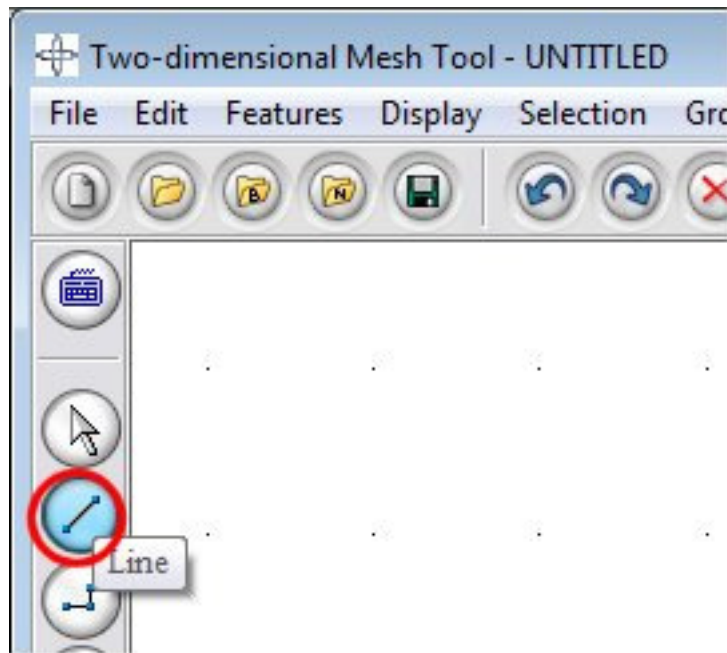

### Inserir linha

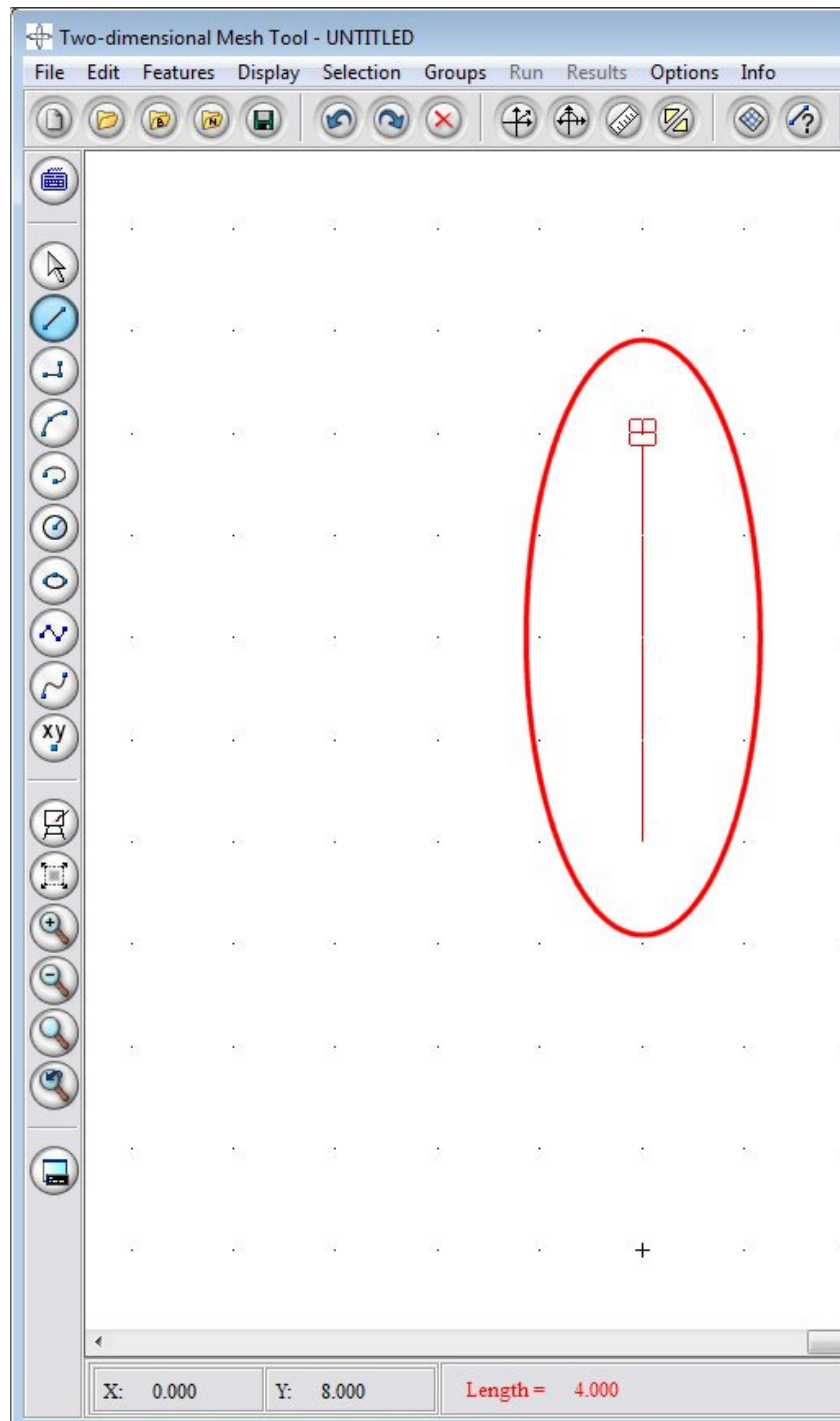



## Inserção das linhas do modelo

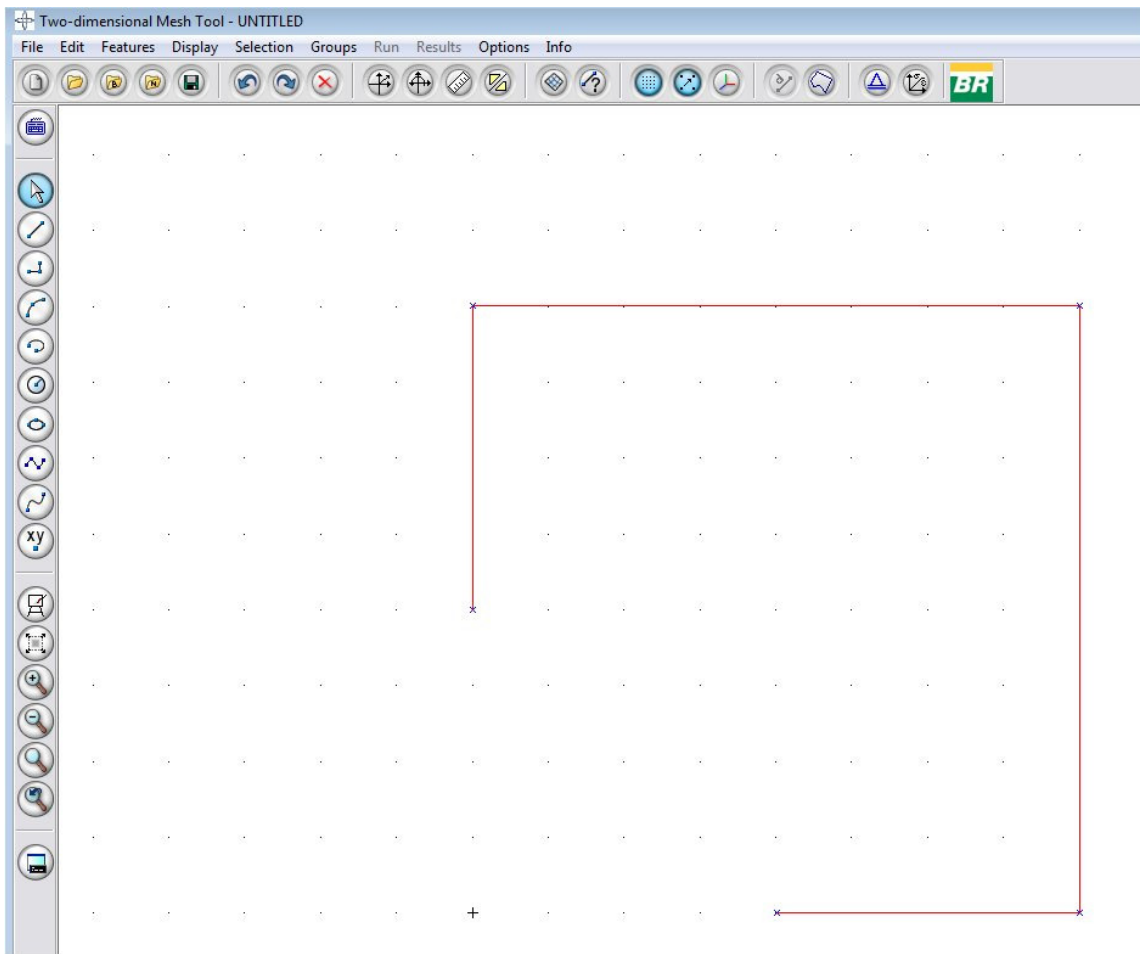



## Botão de inserção de arco

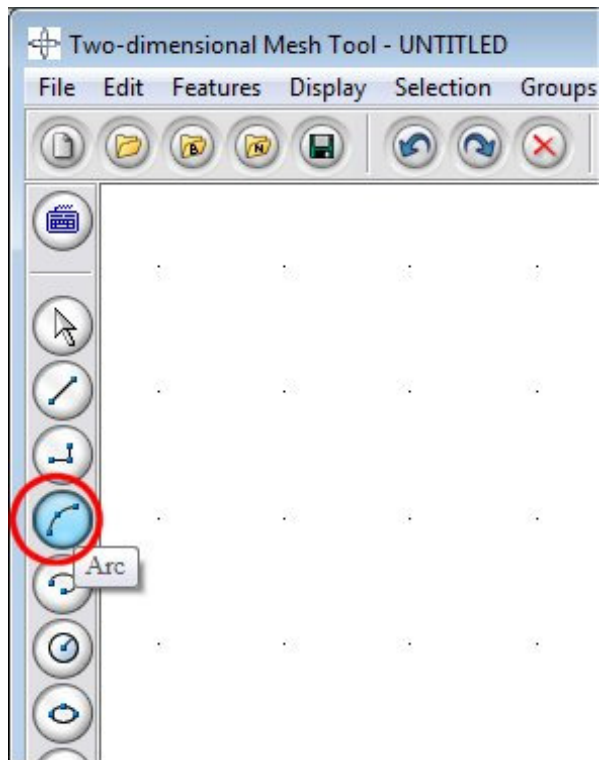

## Inserção de arco no modelo

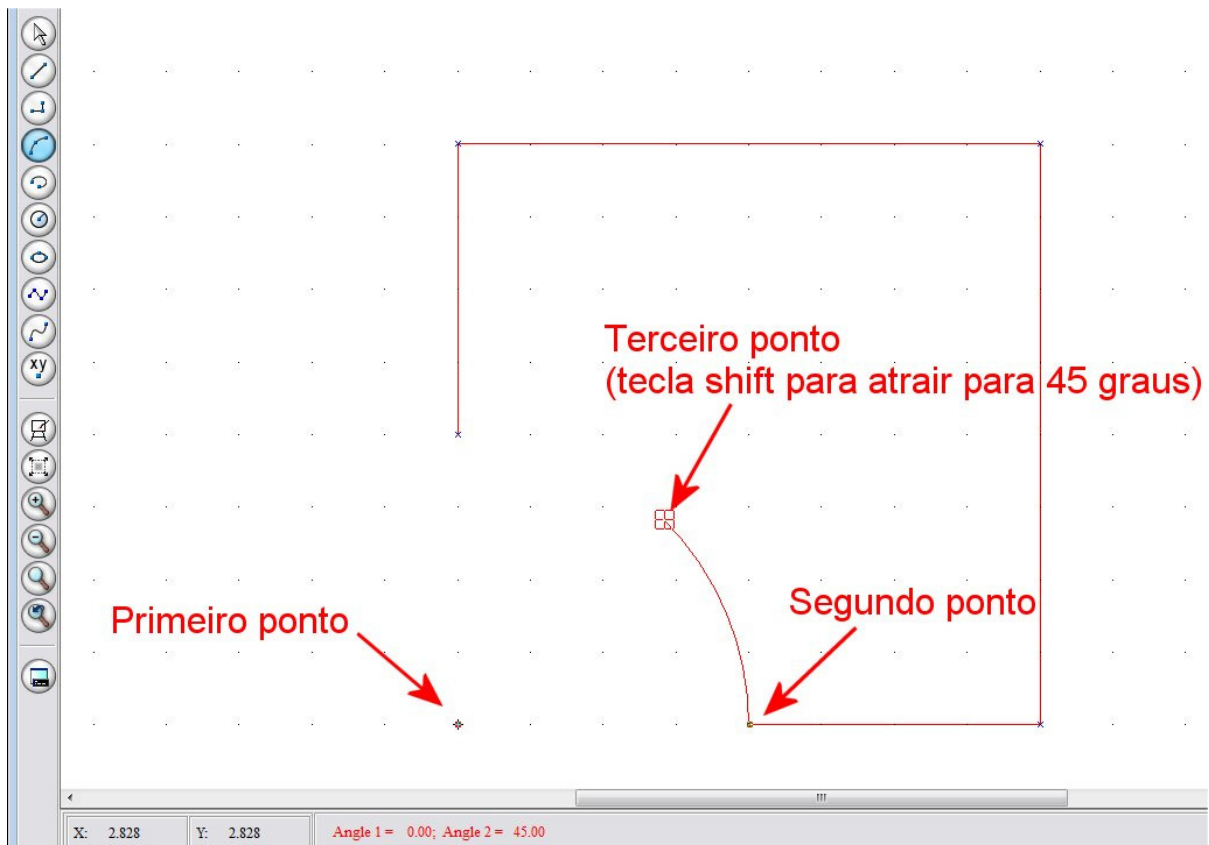



## Inserção de segundo arco no modelo

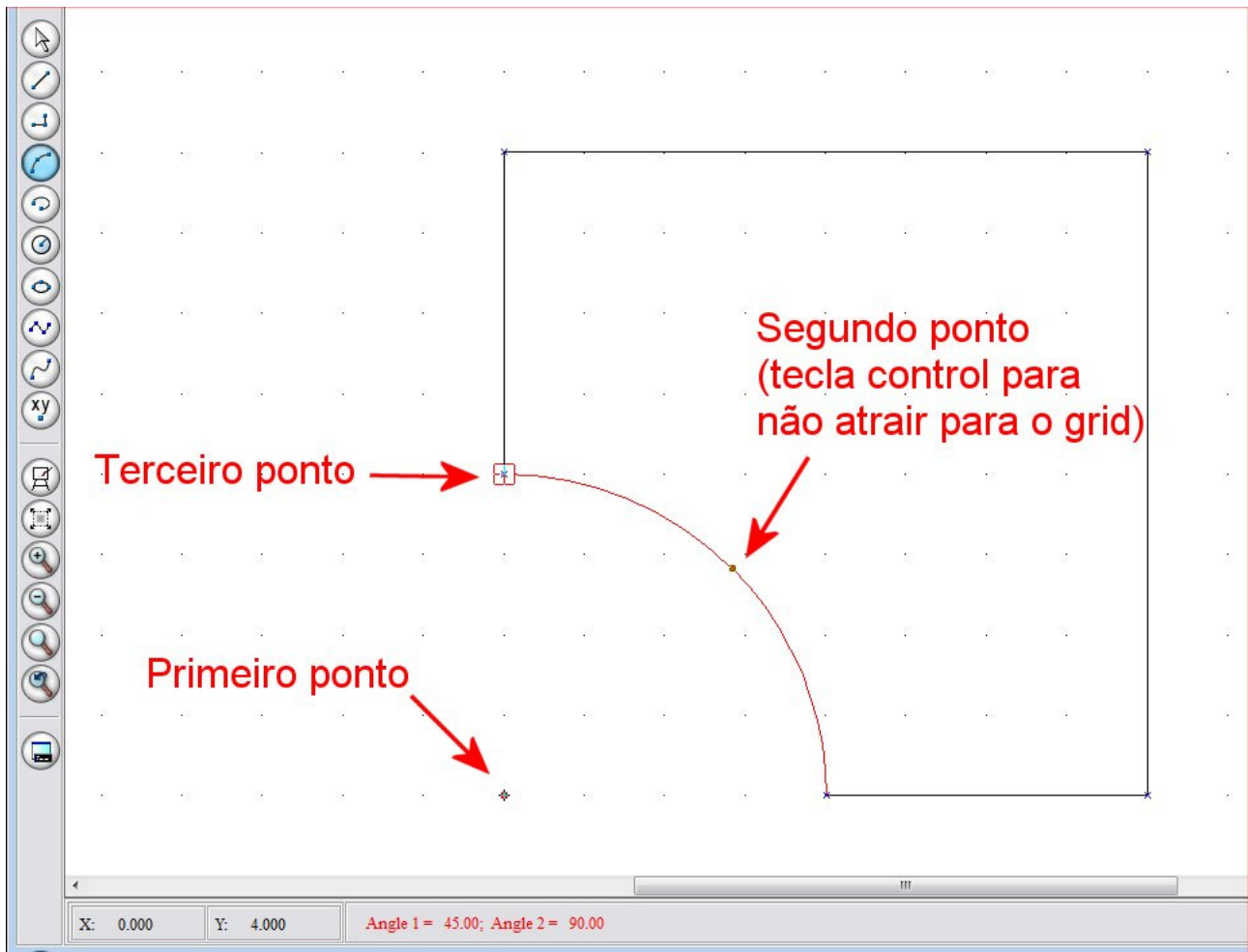



## Criação de região após encontro de arco e linha

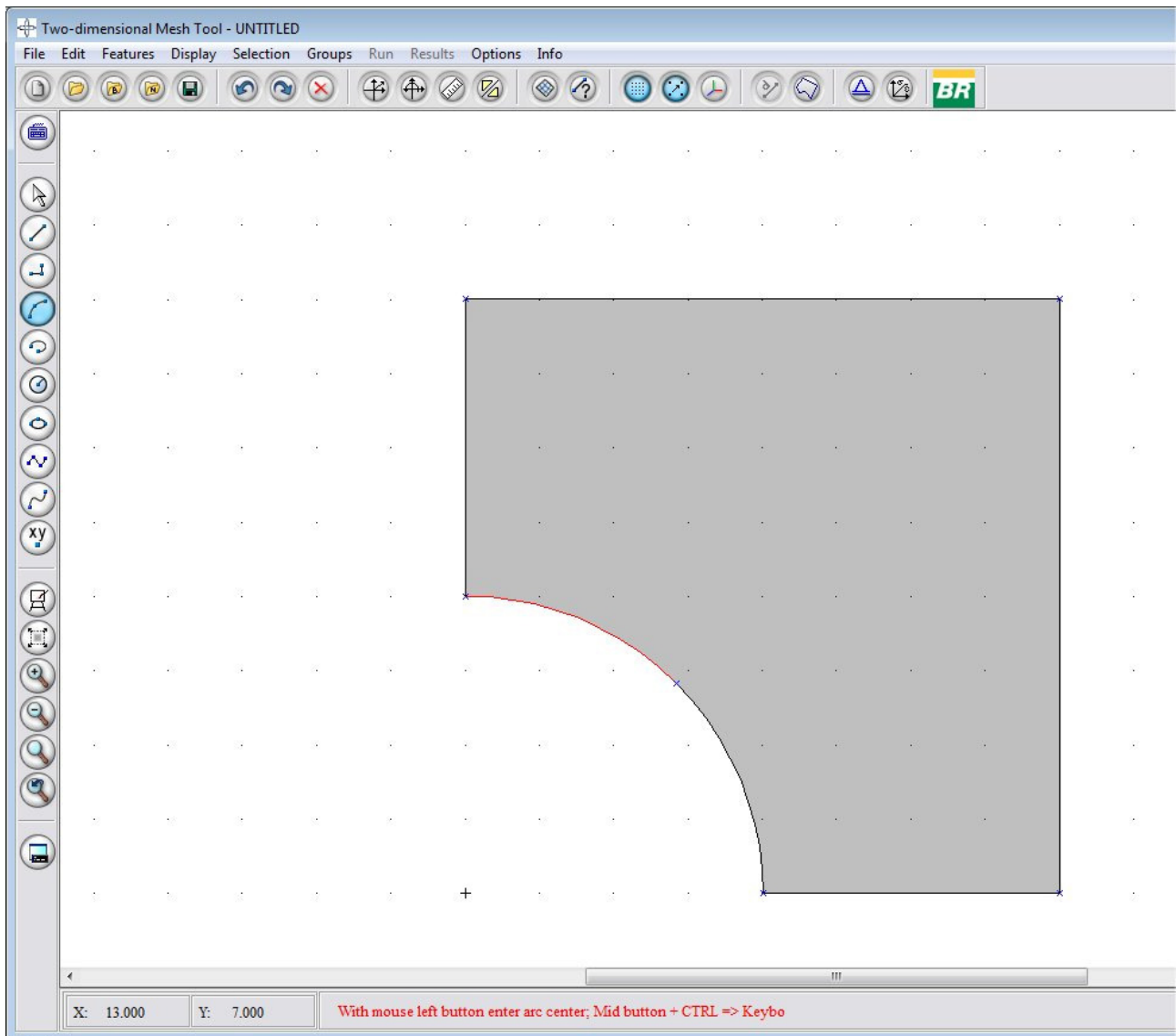





### Salva projeto com um nome (comando "Save Project As... ")

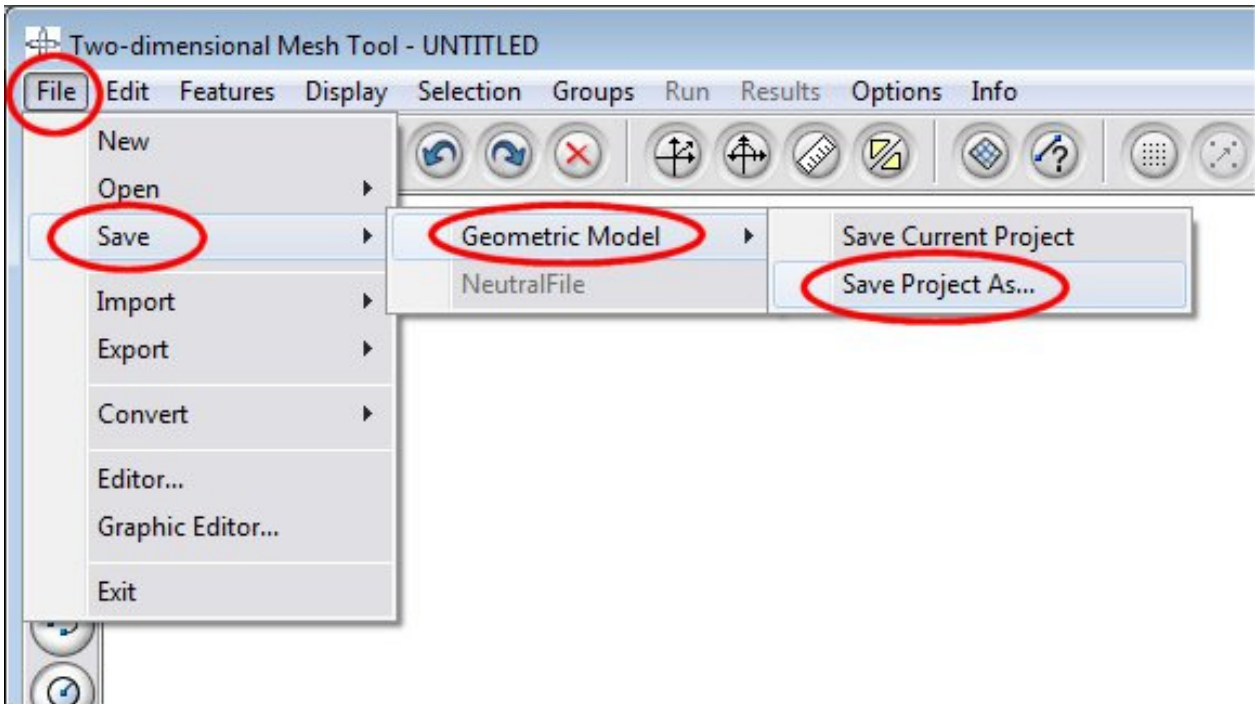

### Salva projeto com um nome (comando "Save Project As... ")

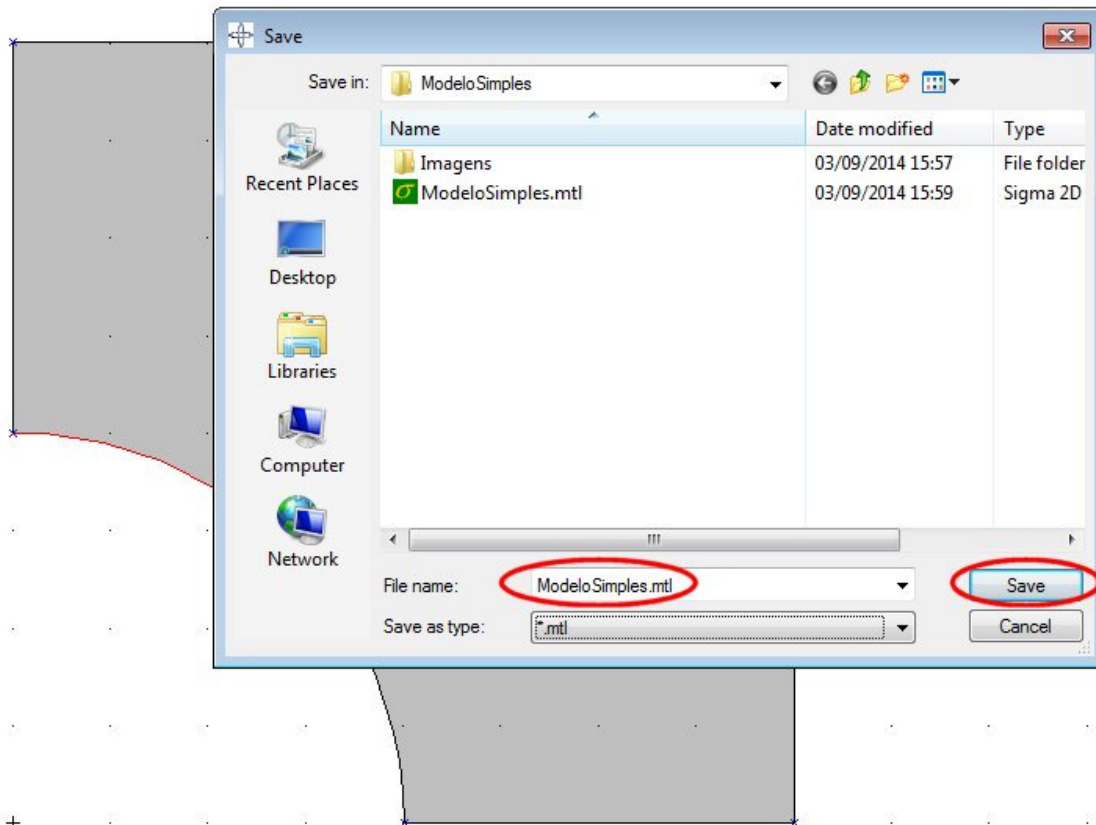



### Criar linha que divide a região

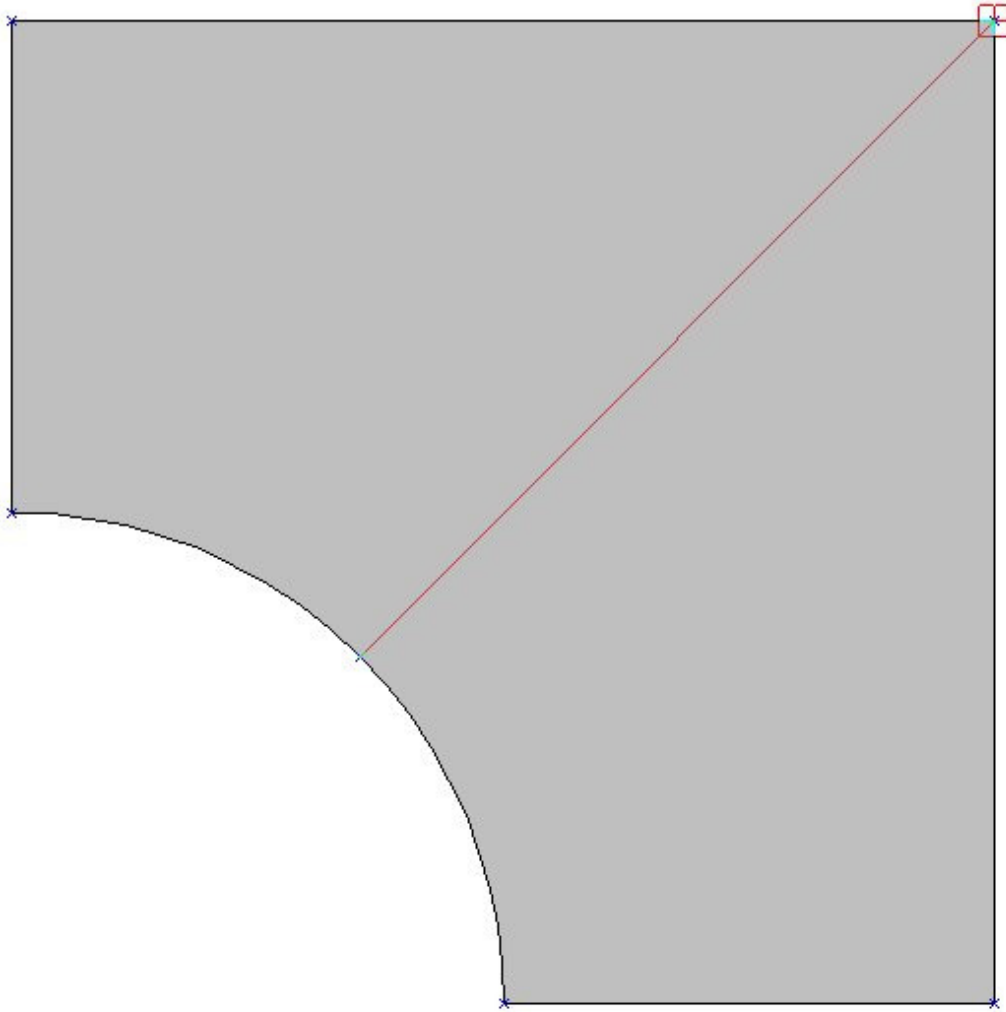



### Região dividida automaticamente

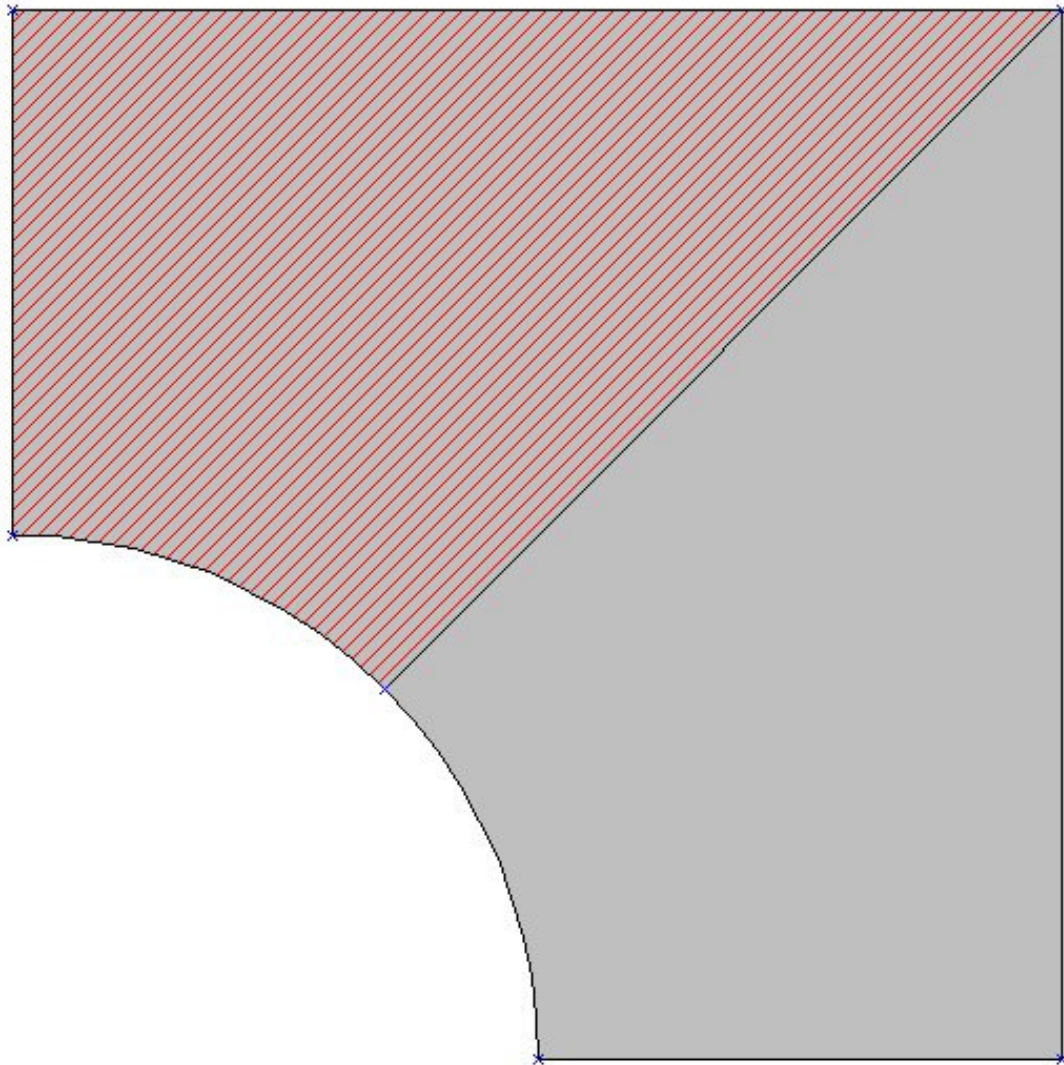



## Subdividir curvas

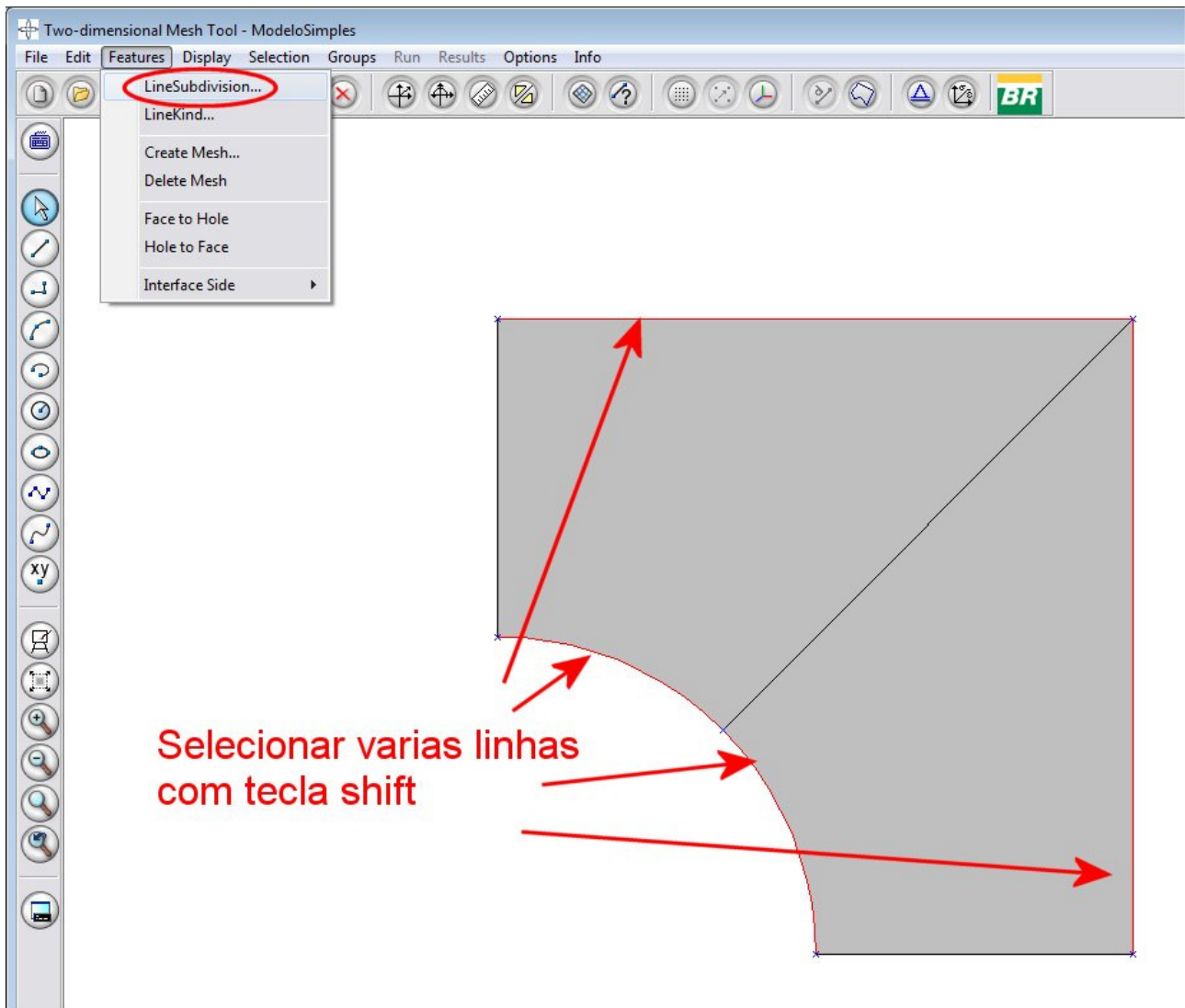



### Aplicar subdivisão de curvas

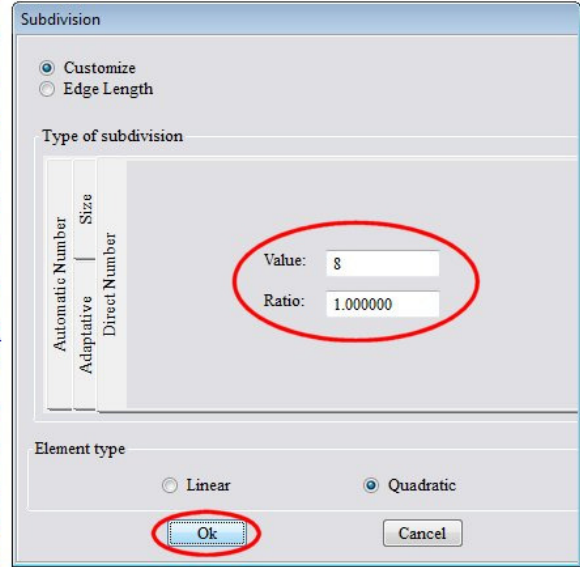
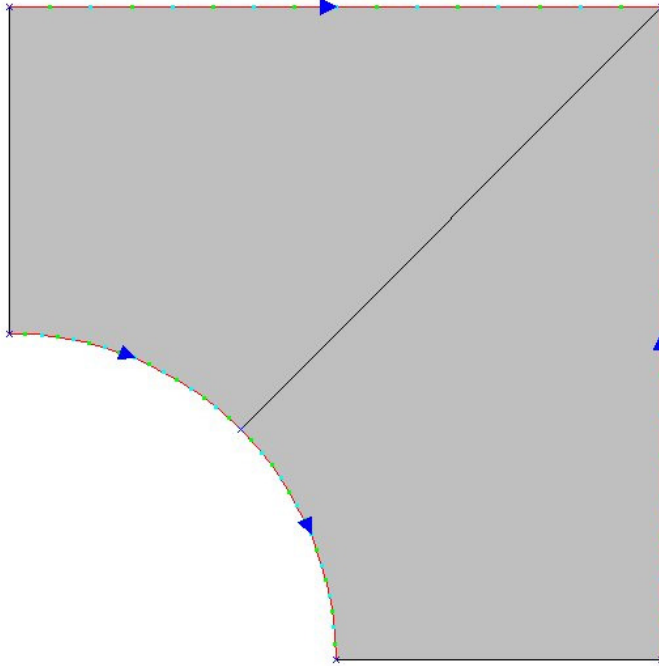

### Aplicar subdivisão nas outras curvas do modelo

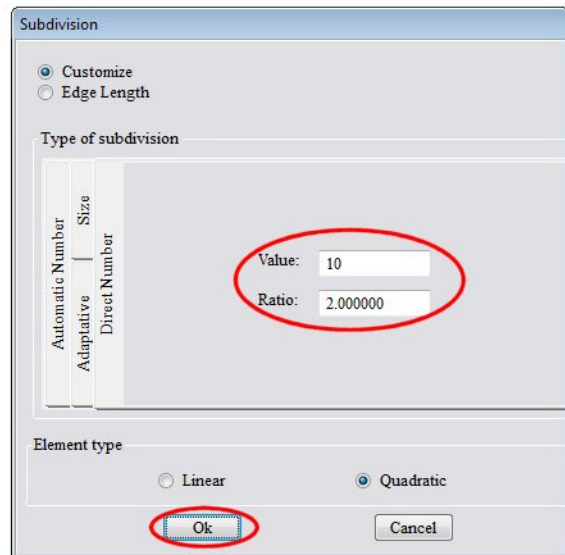
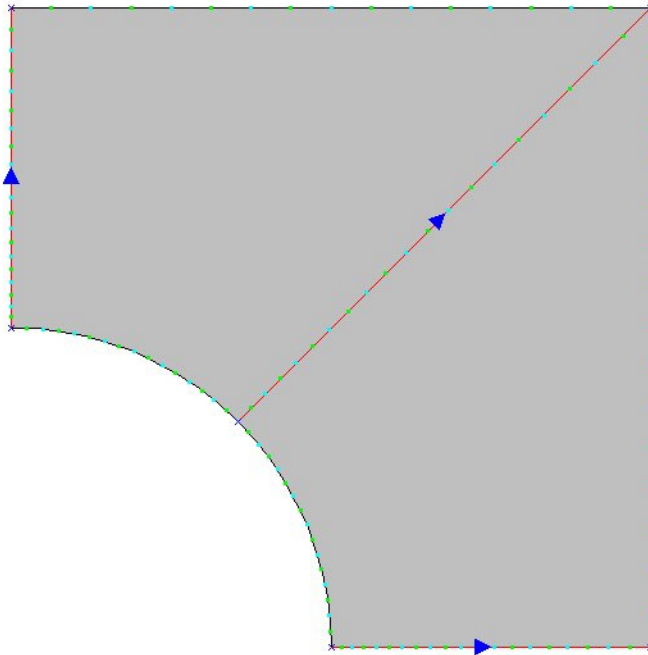



## Procedimento para criar malha

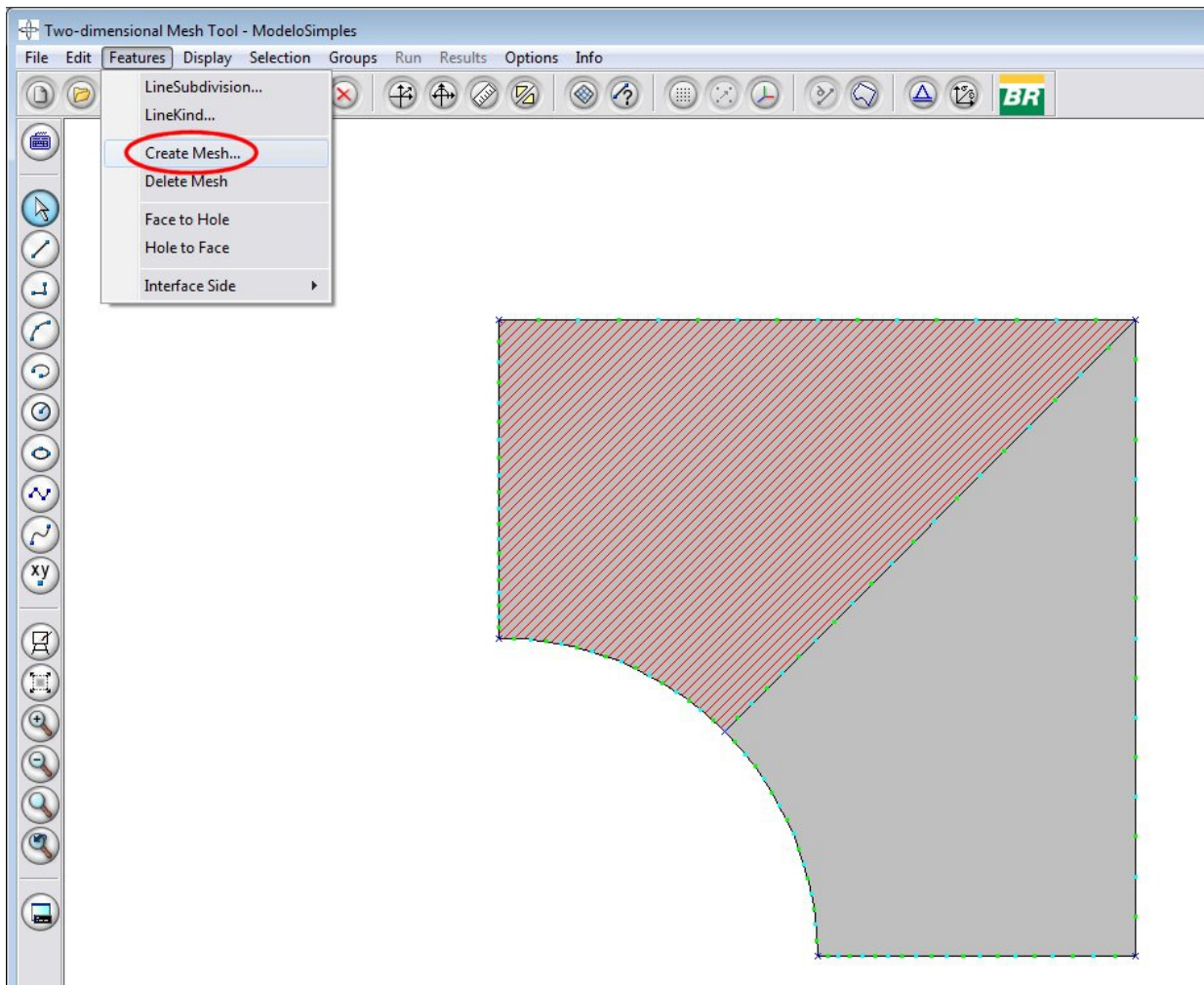

## Aplicação de malha bilinear quadrática

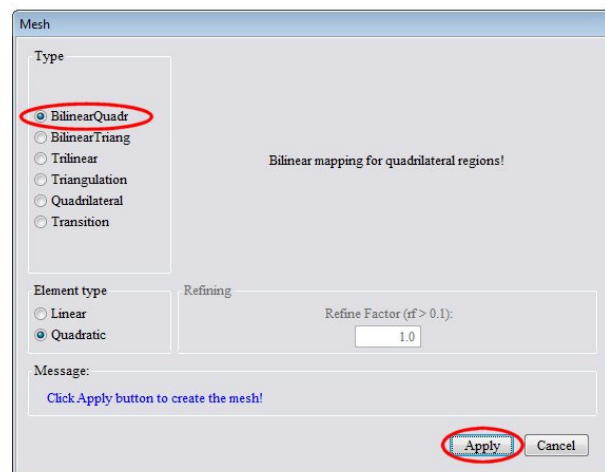
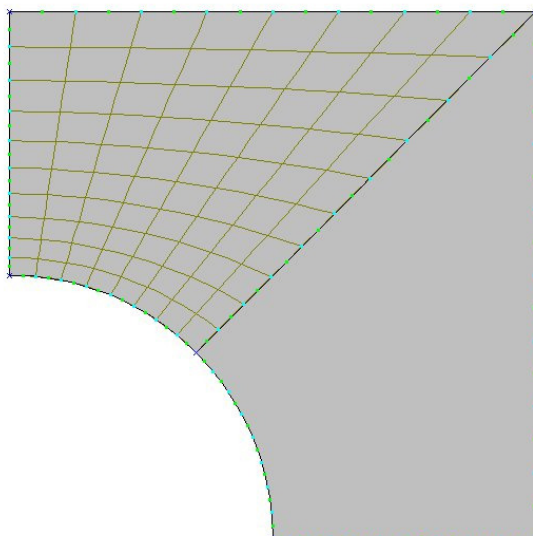



## Aplicação da malha na segunda parte da região

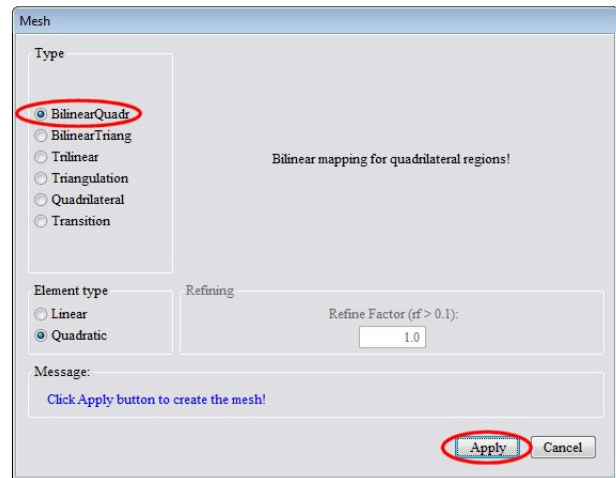
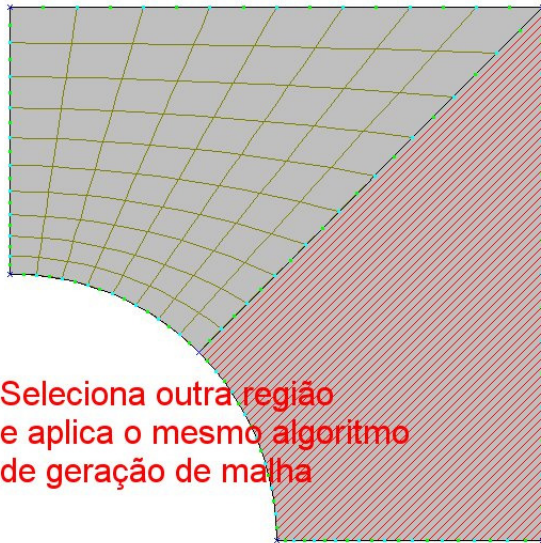

## Salva modelo com a malha criada

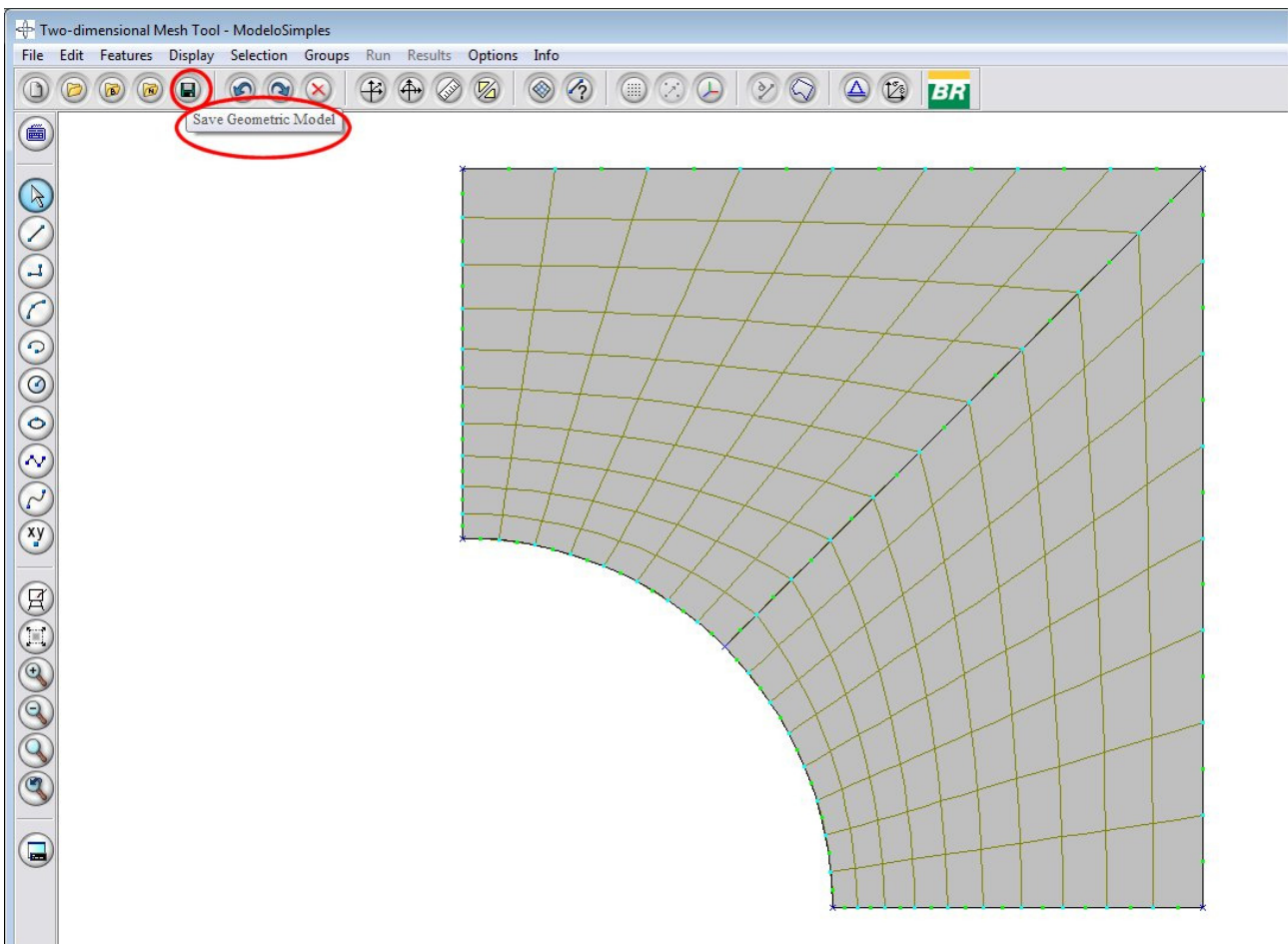



## Seleção de restrições de deslocamento

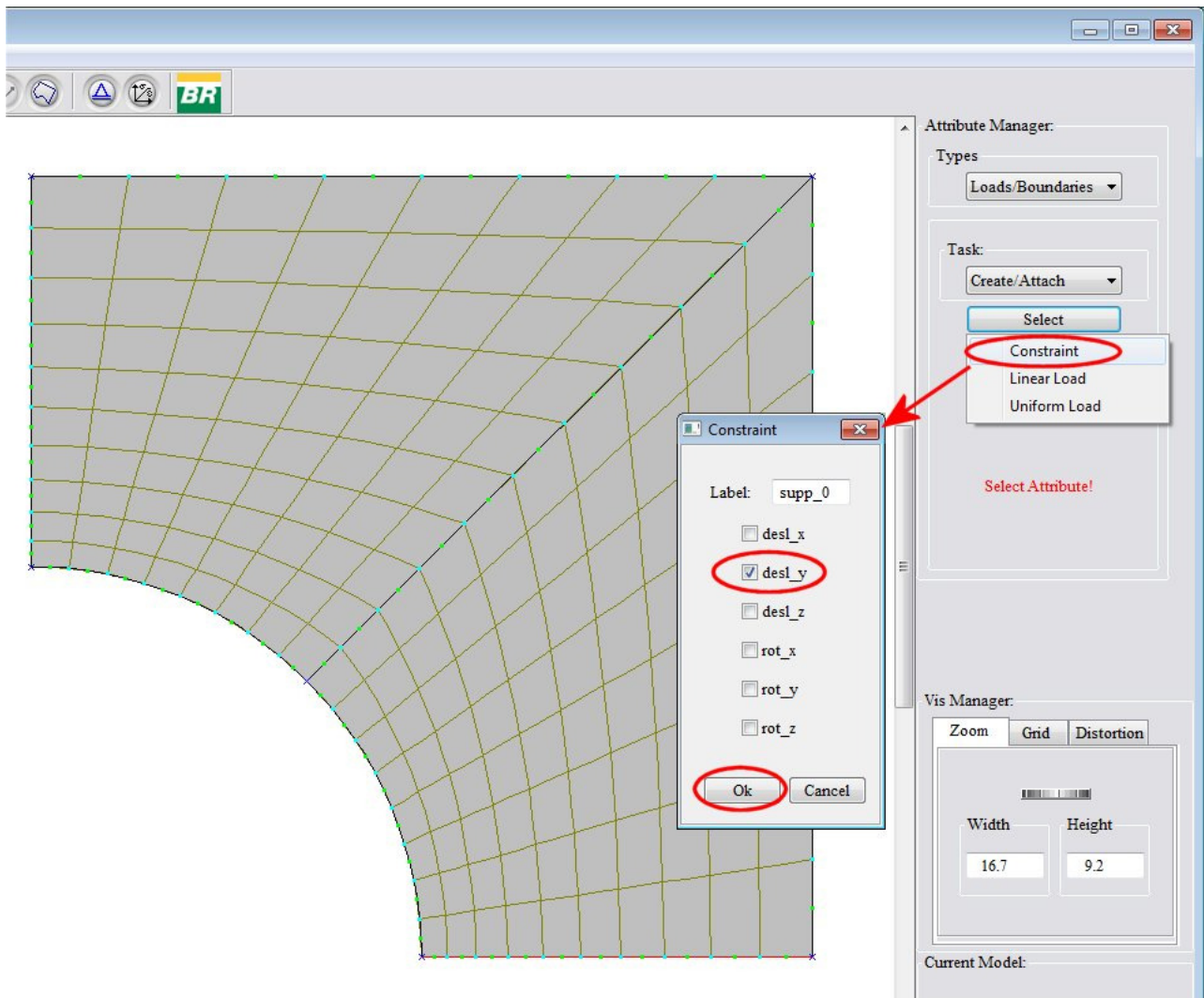





### Aplicar restrições de deslocamento ao modelo

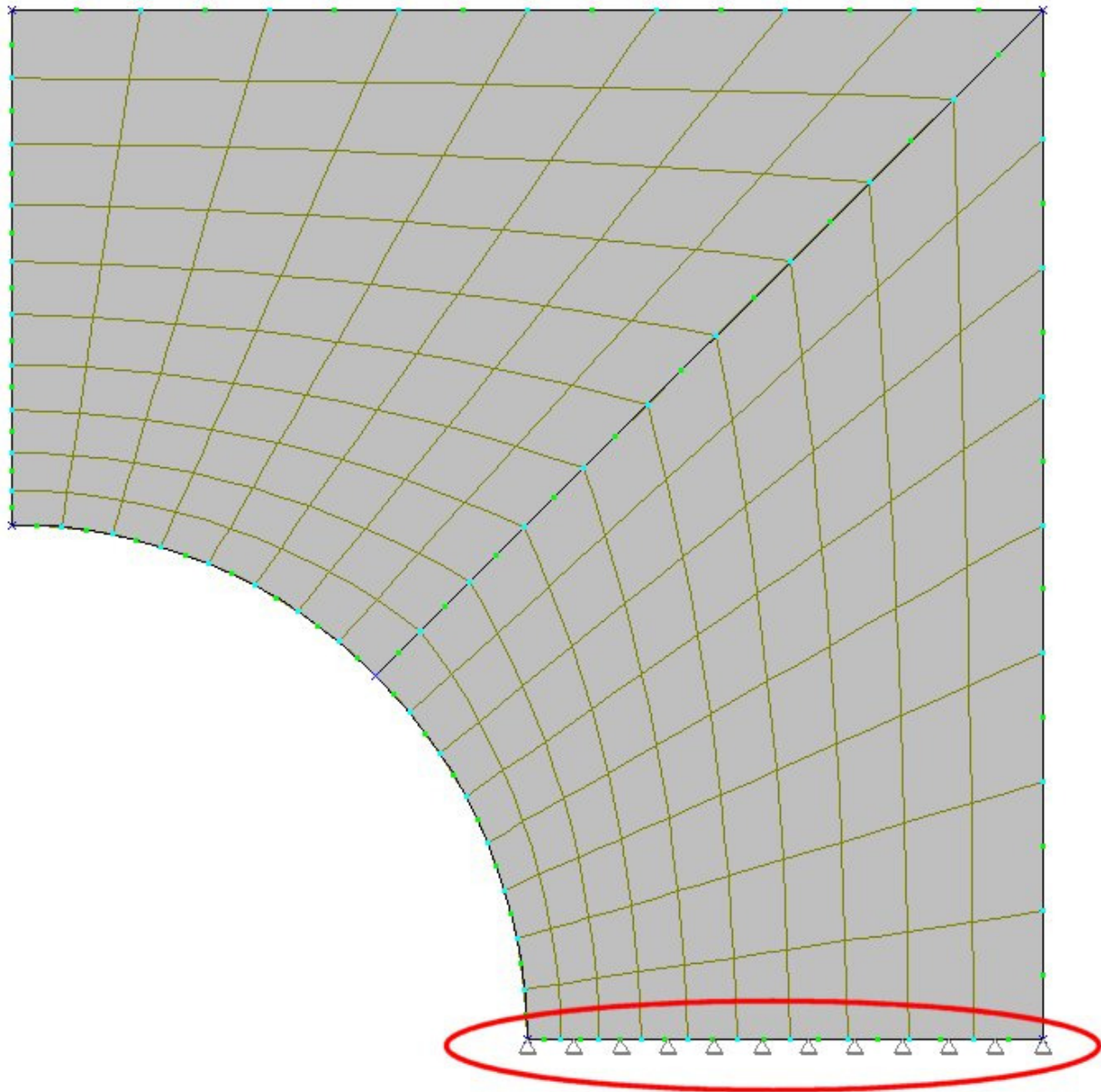



## Aplicar de restrições de deslocamento ao modelo

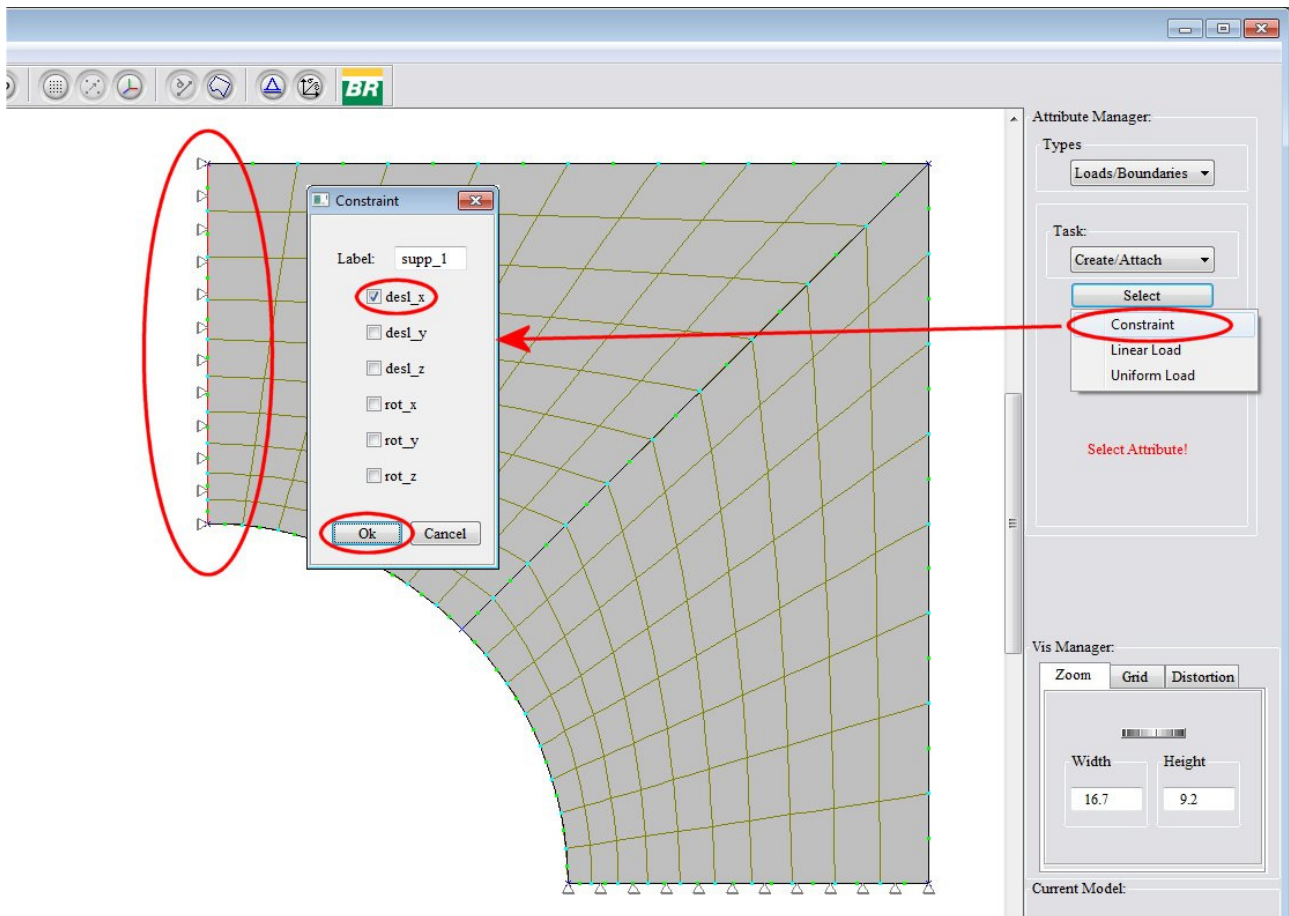



### Seleção de atributo de carregamento uniforme

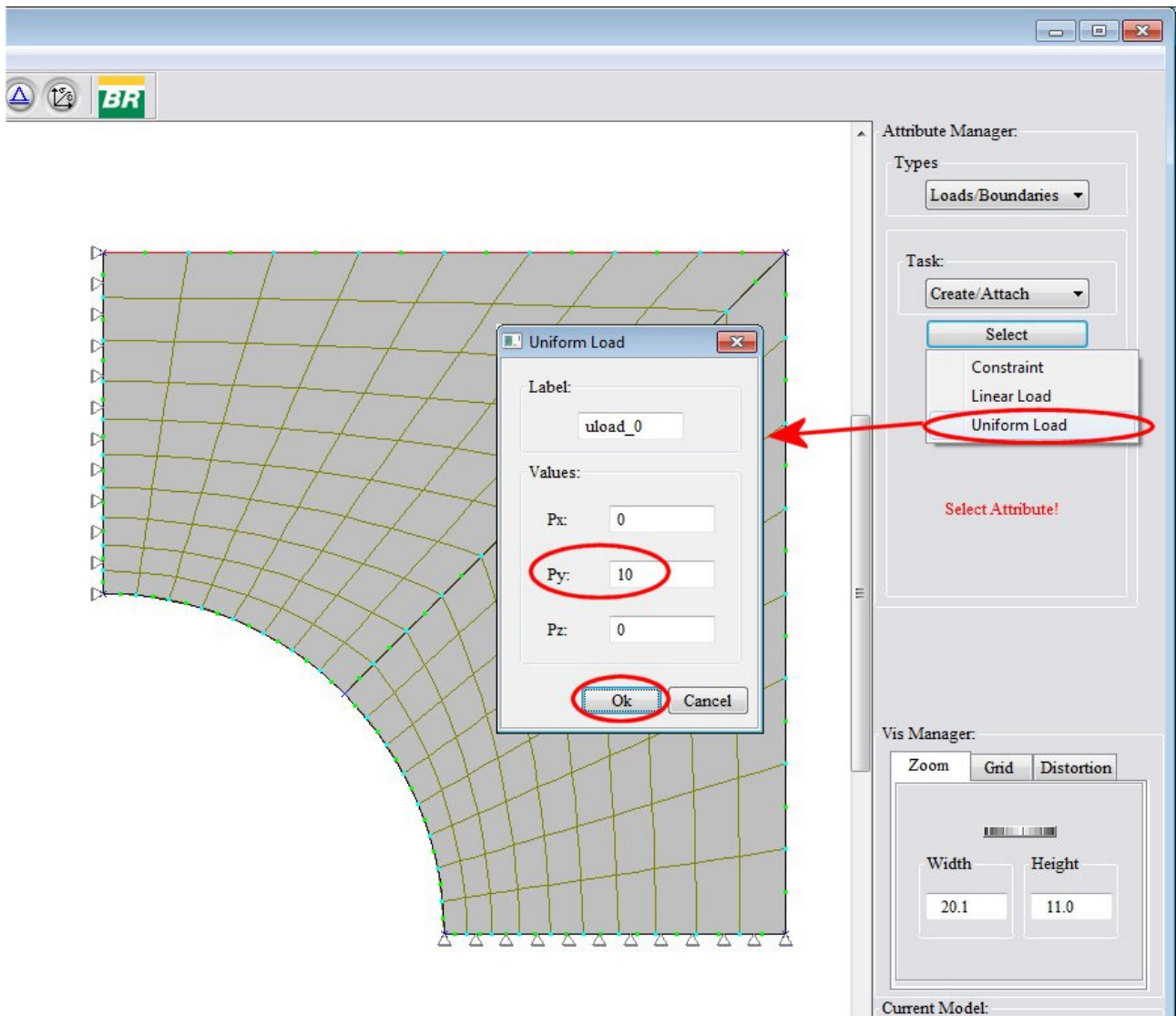



### Aplicar atributo de carregamento uniforme

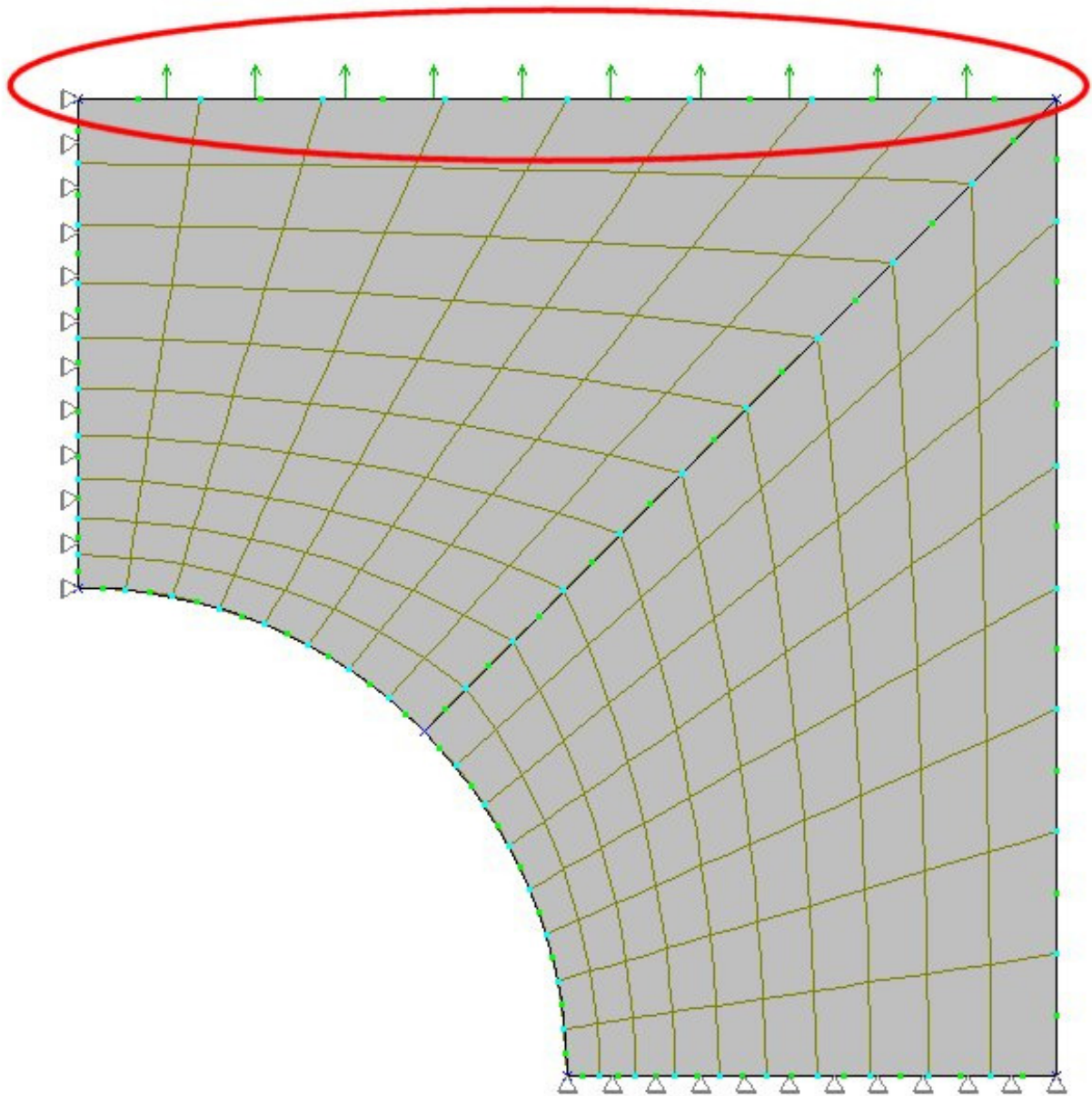



## Seleção de atributo de material

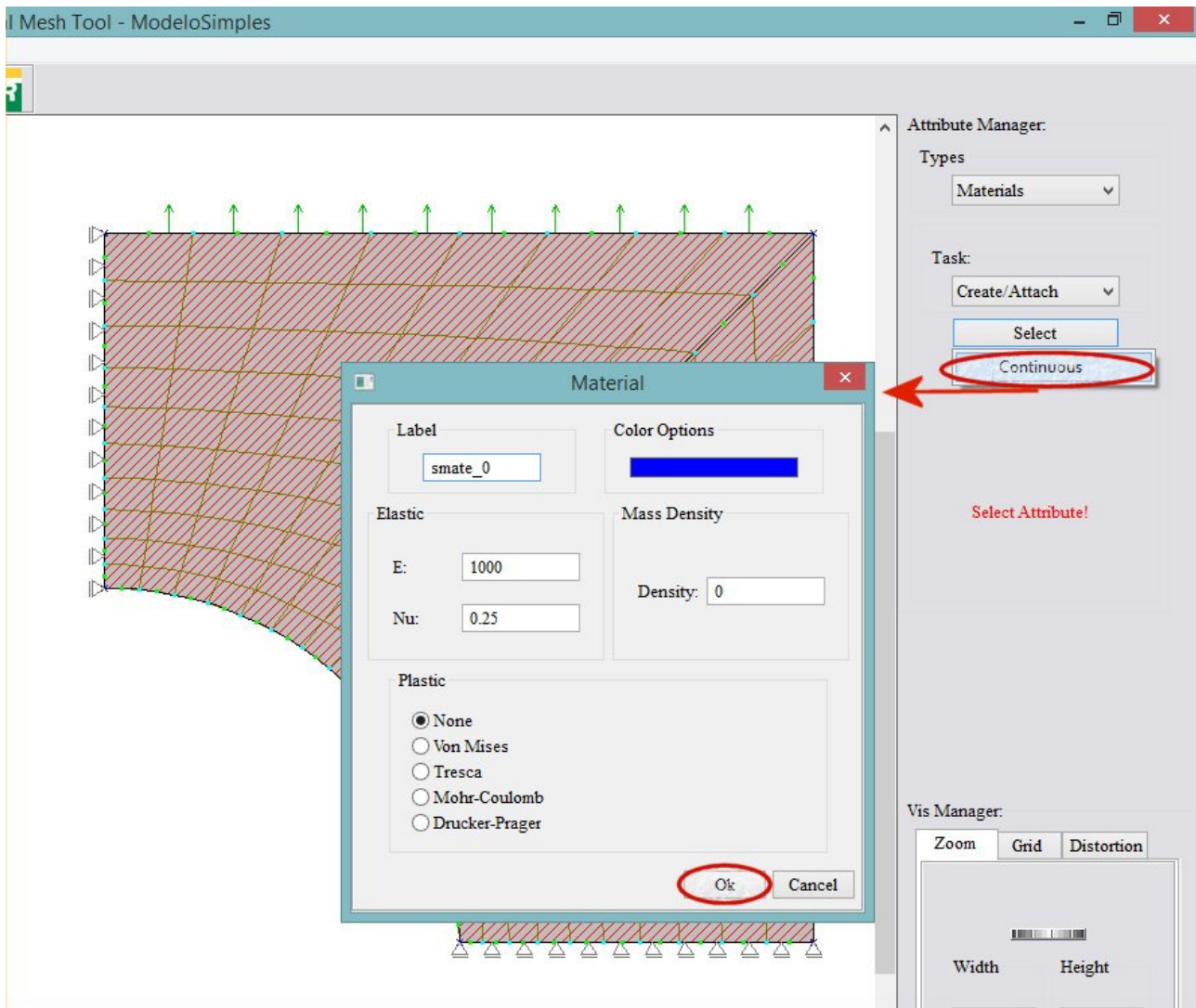



### Aplicar atributo de material ao modelo

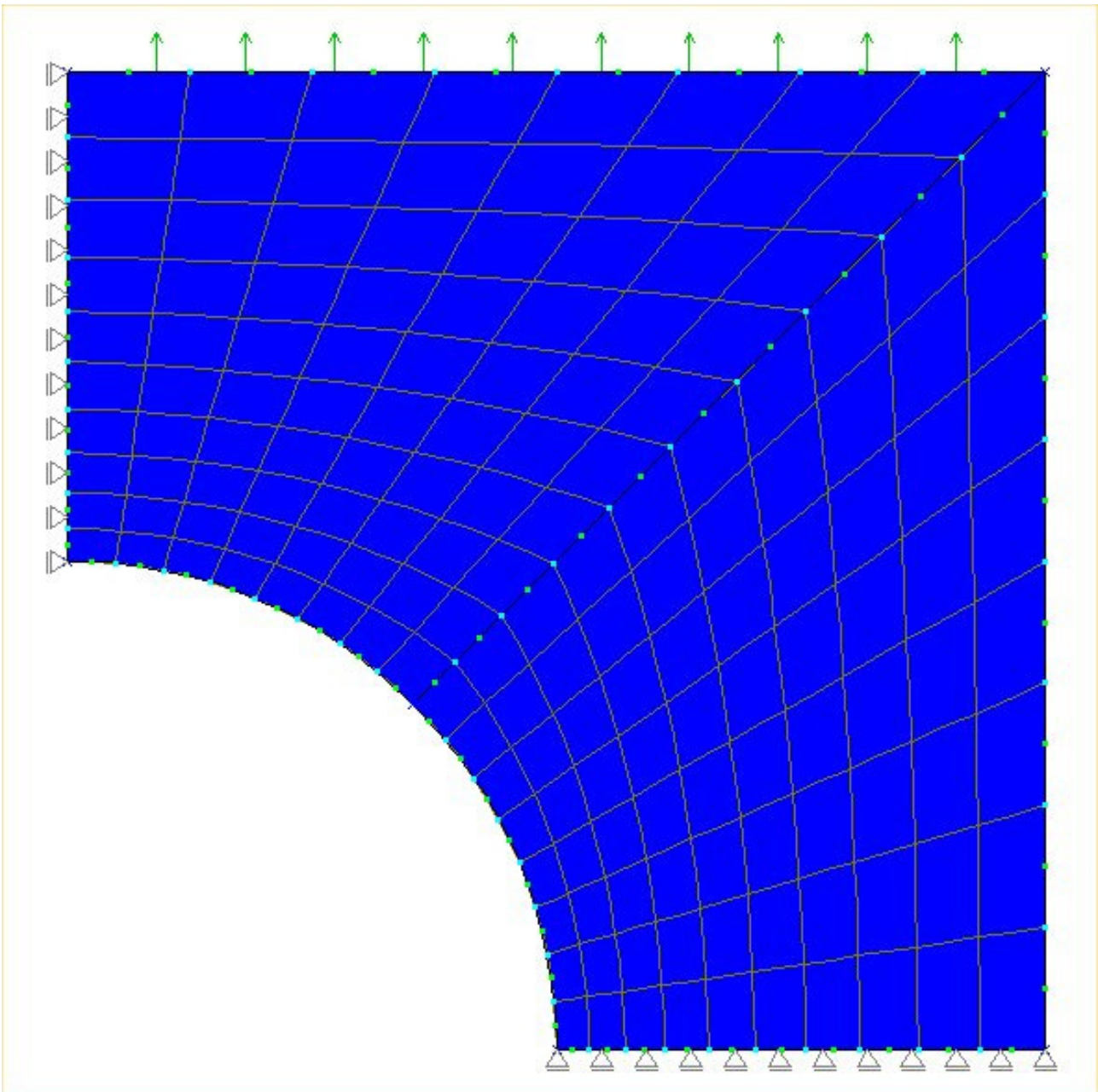



### Selecionar atributos de tipo de análise

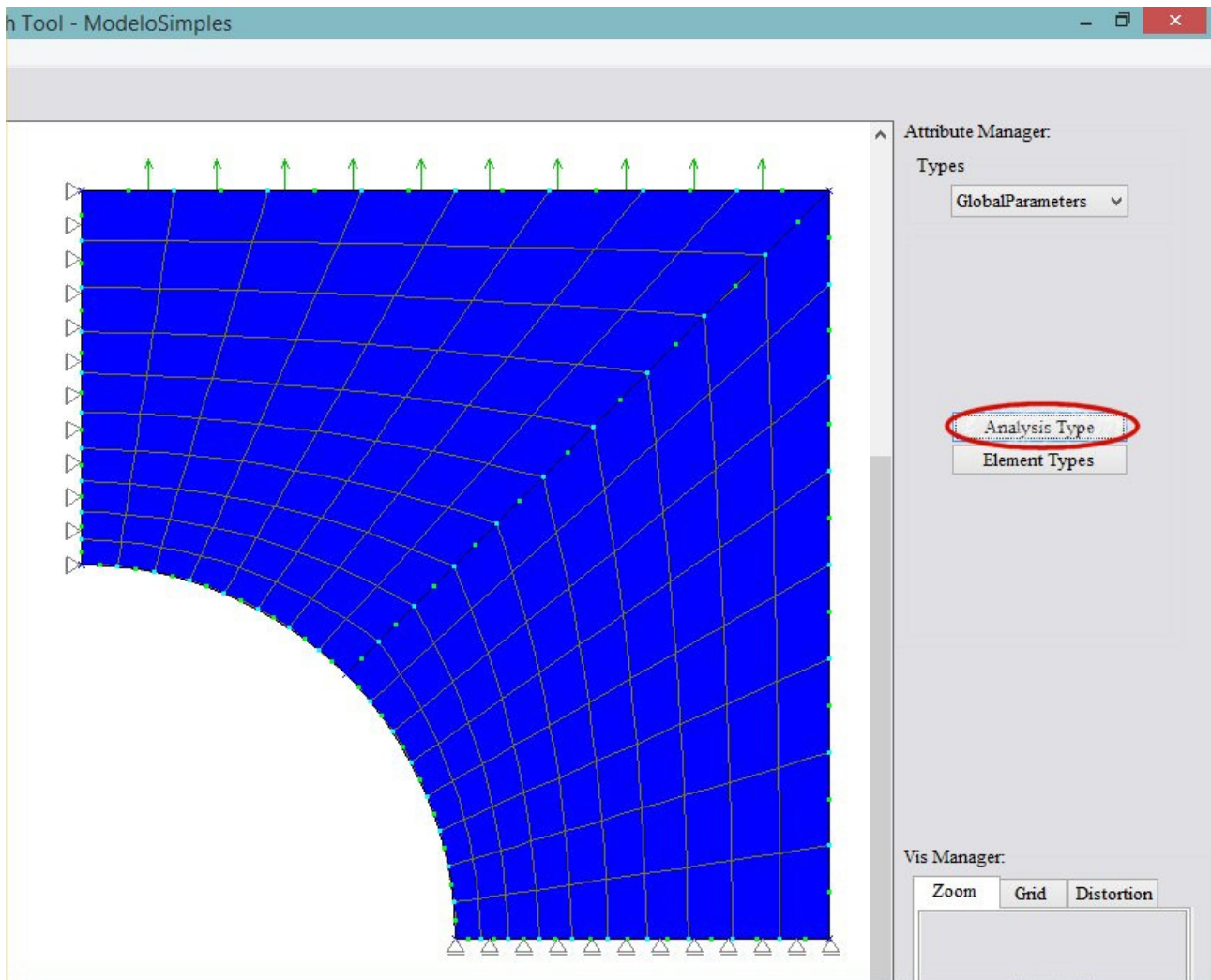



### Aplicar atributos de tipo de análise

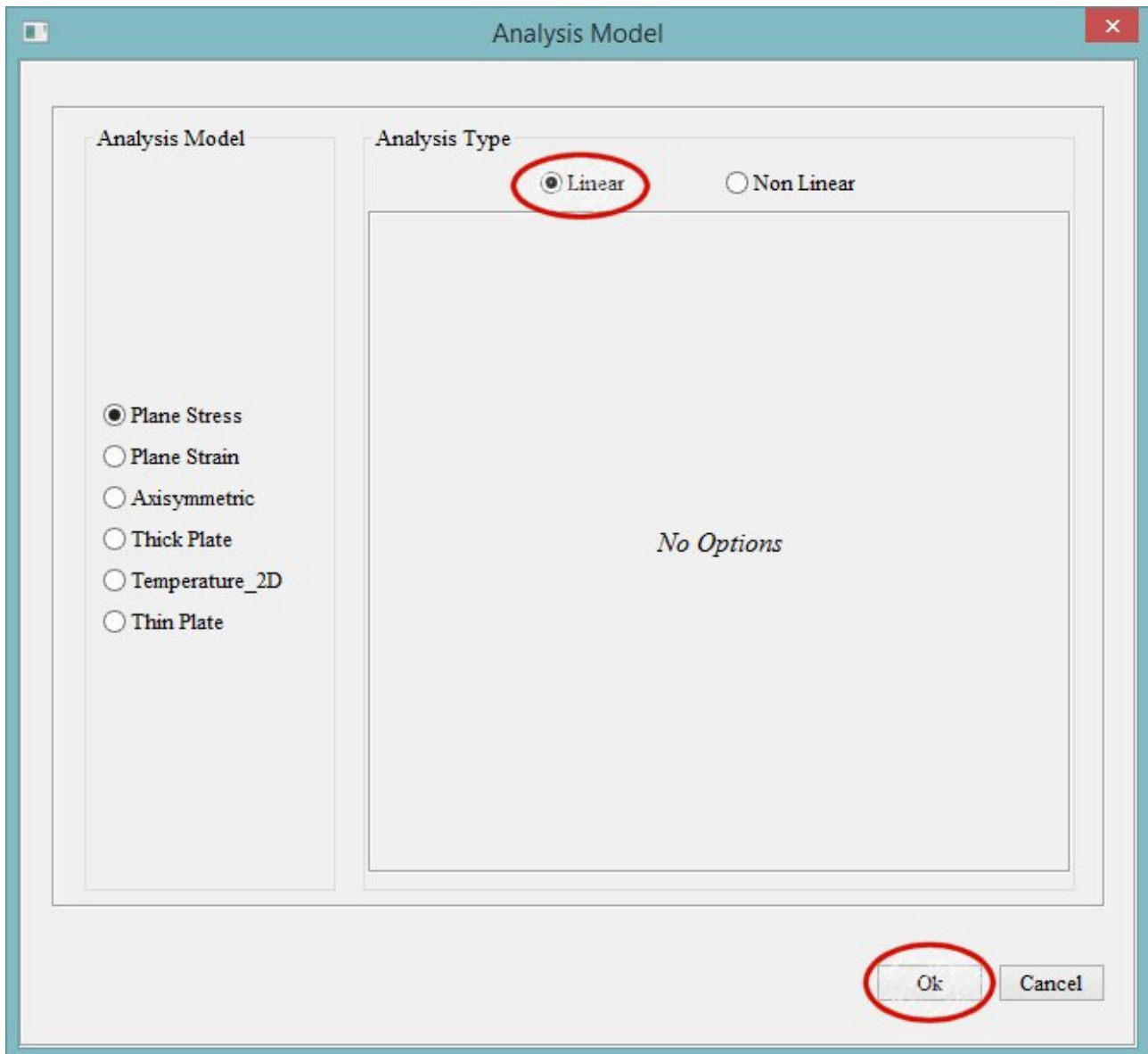





## Selecionar atributos de tipos de elemento

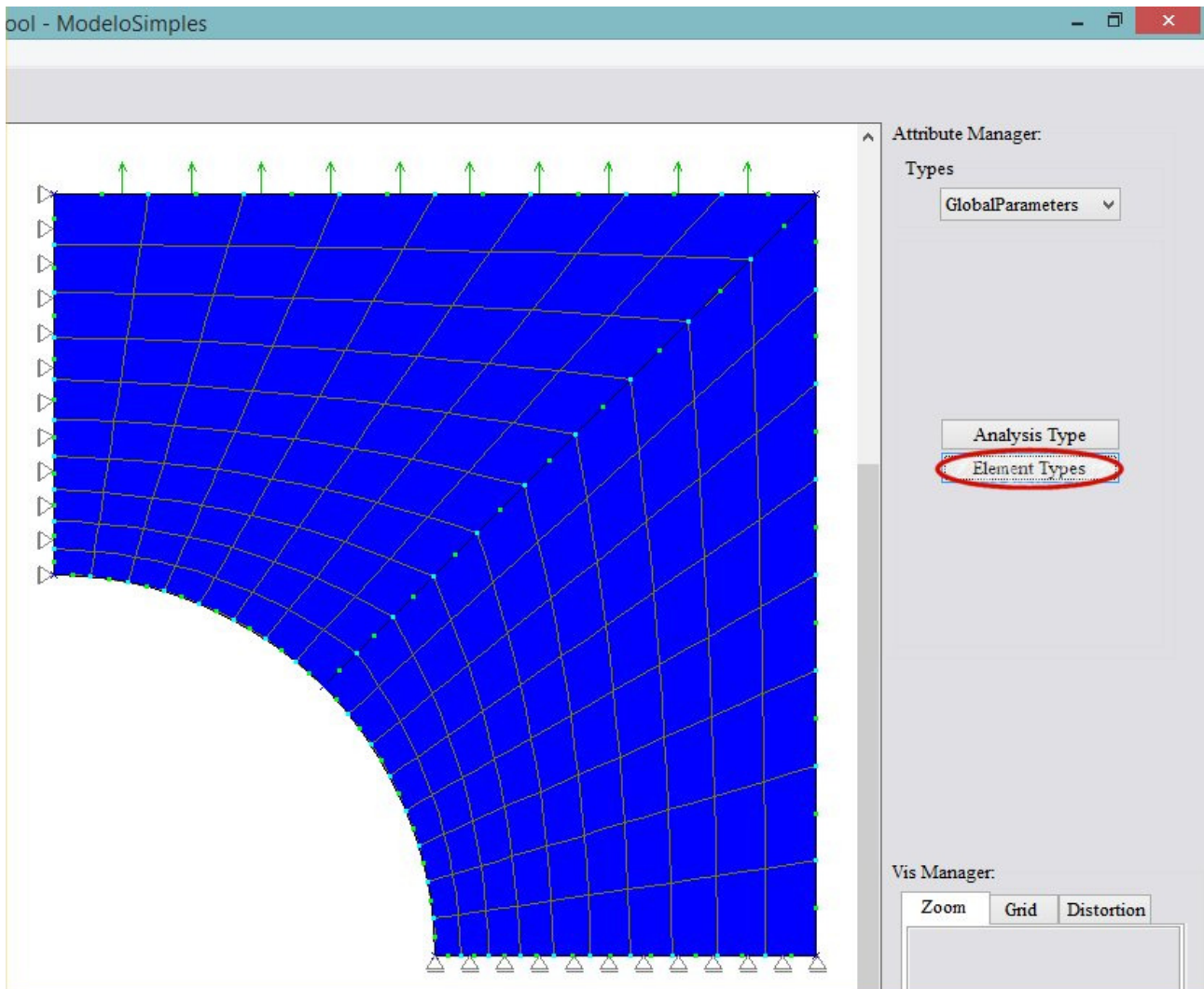



### Aplicar atributos de tipos de elemento ao modelo

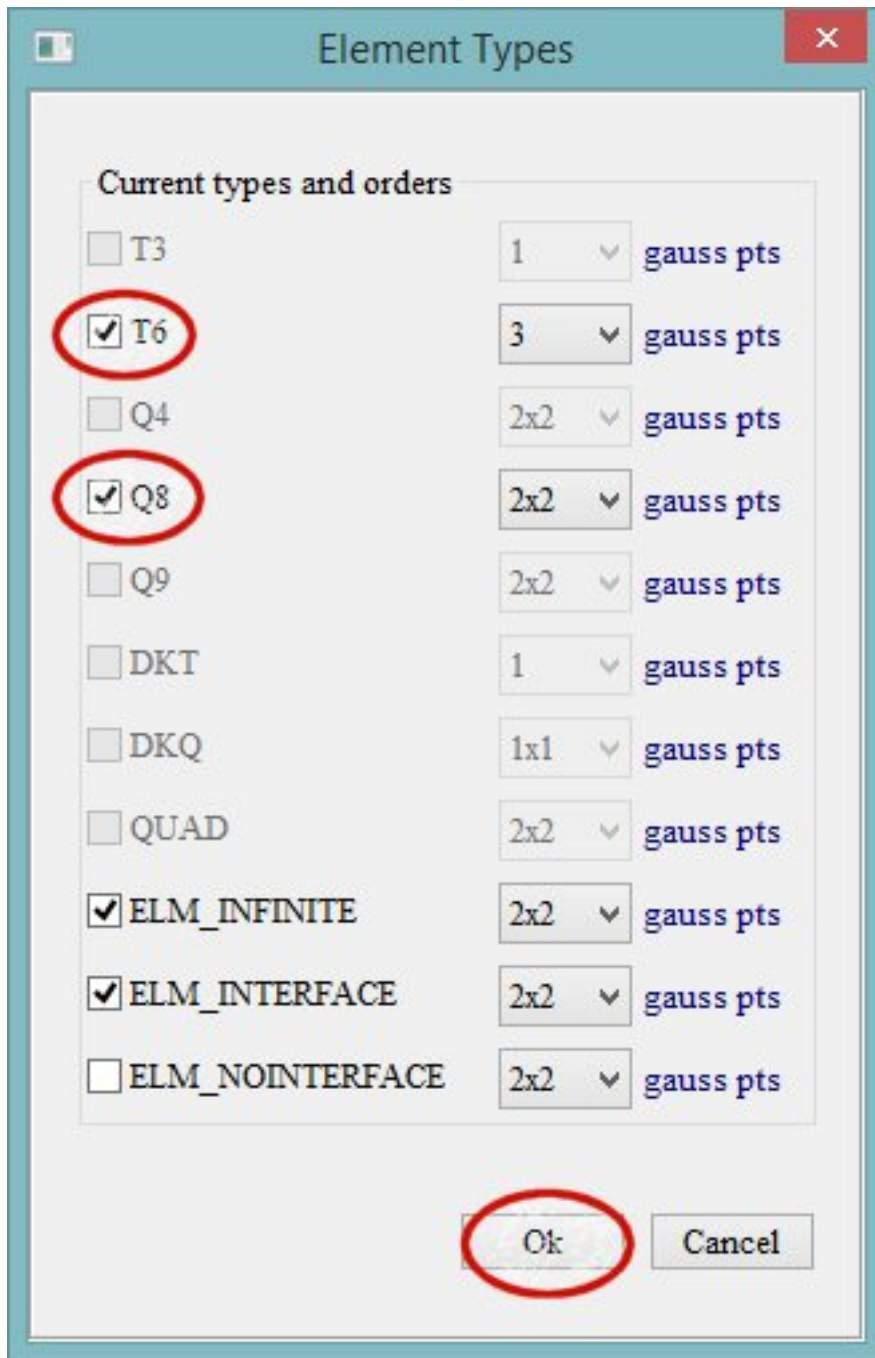



## Converter modelo geométrico para malha de elementos finitos

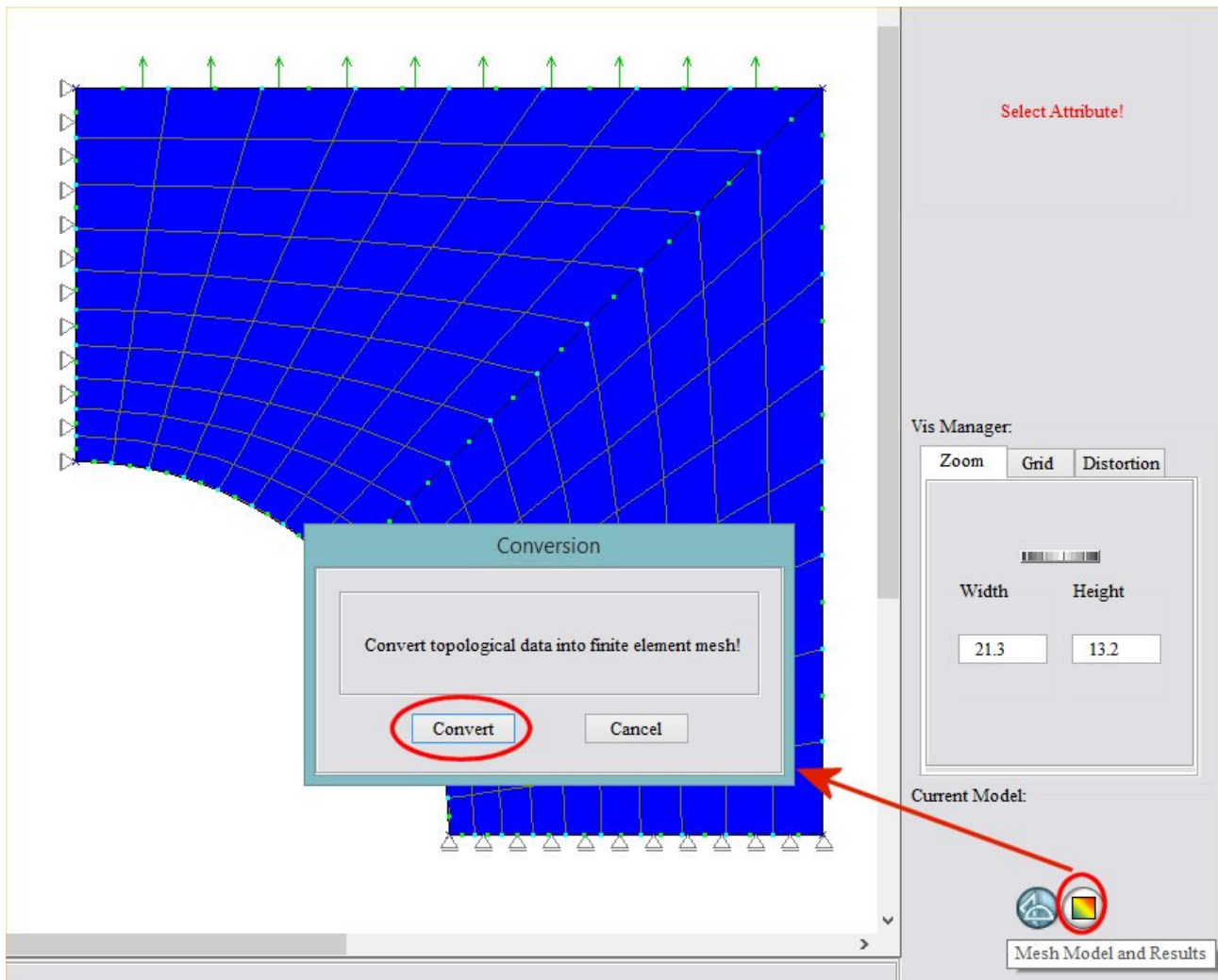



## Rodar análise

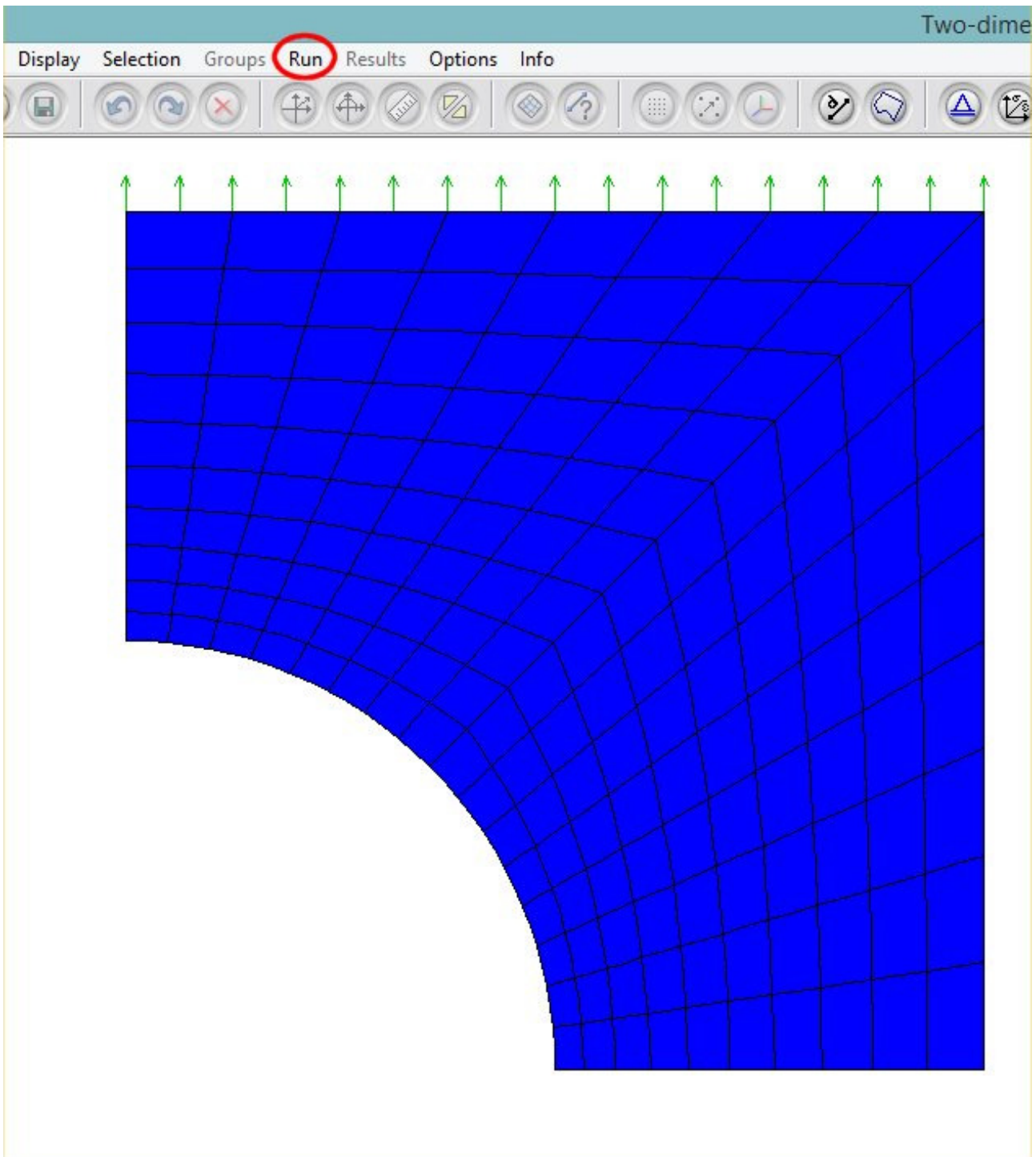



## Informações do modelo

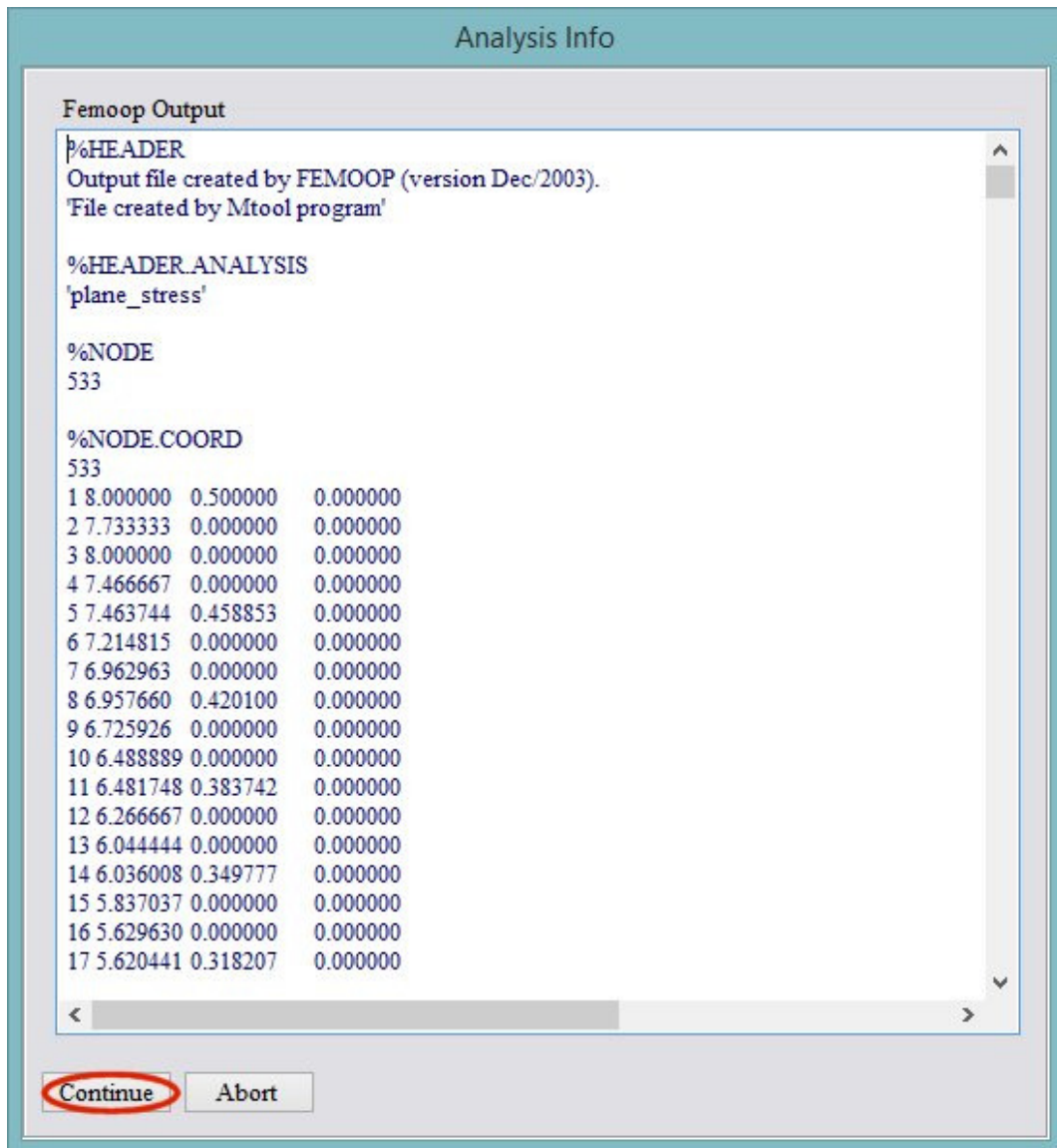

## Escolha dos passos de execução Titulo 2

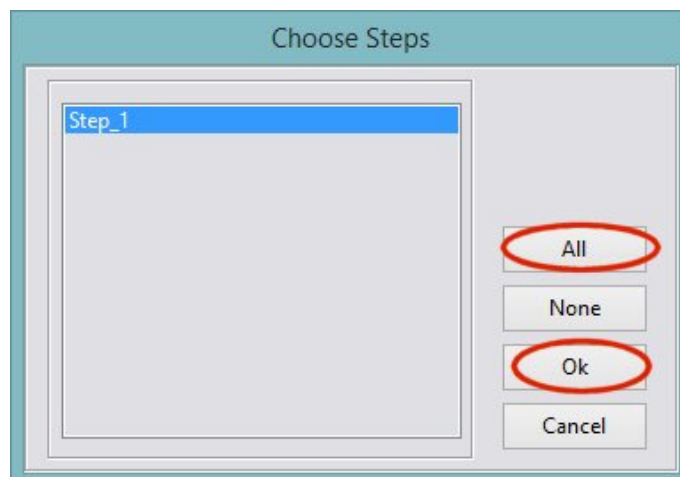



## Salvar Resultados

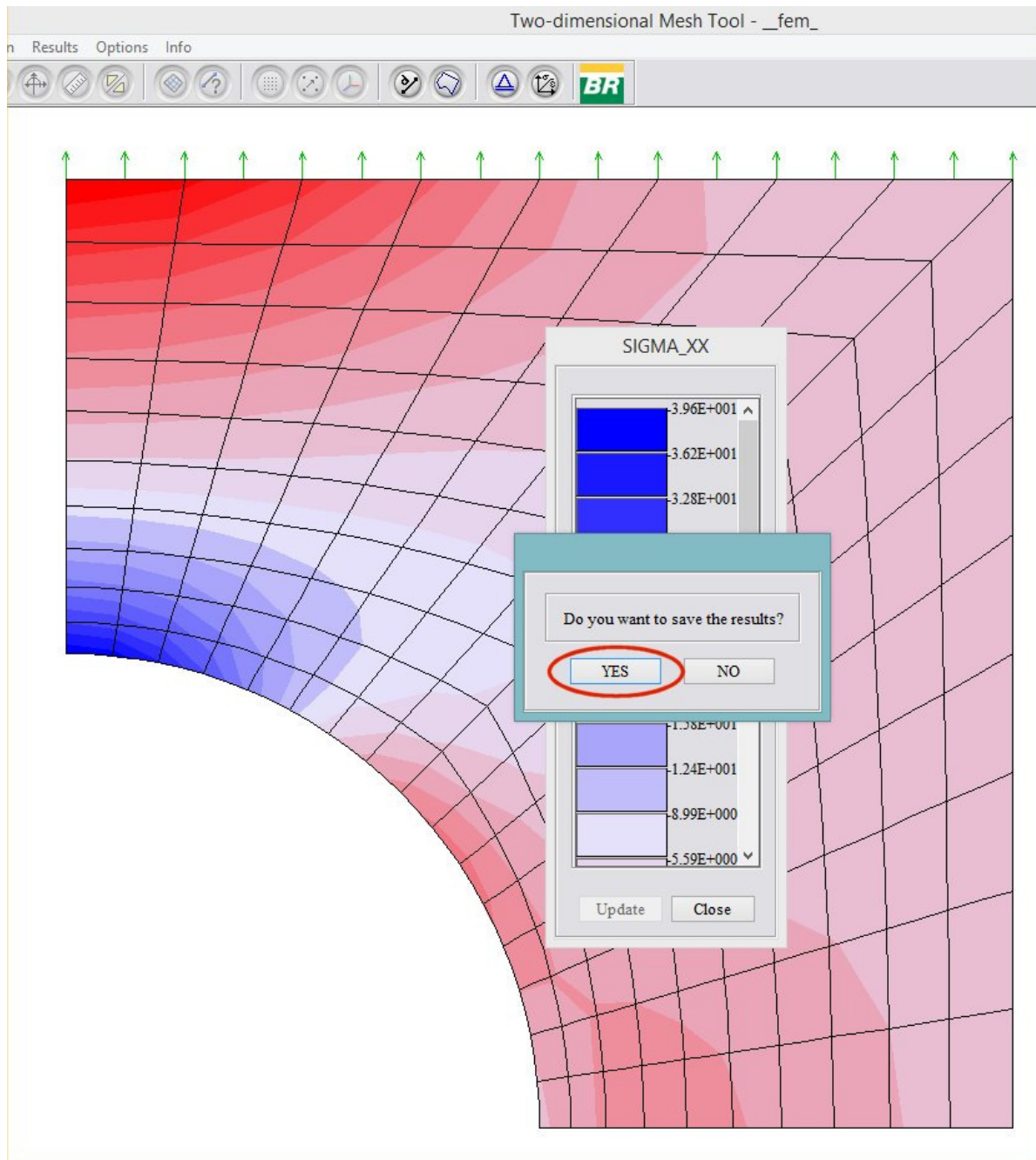



## Salvar Resultado

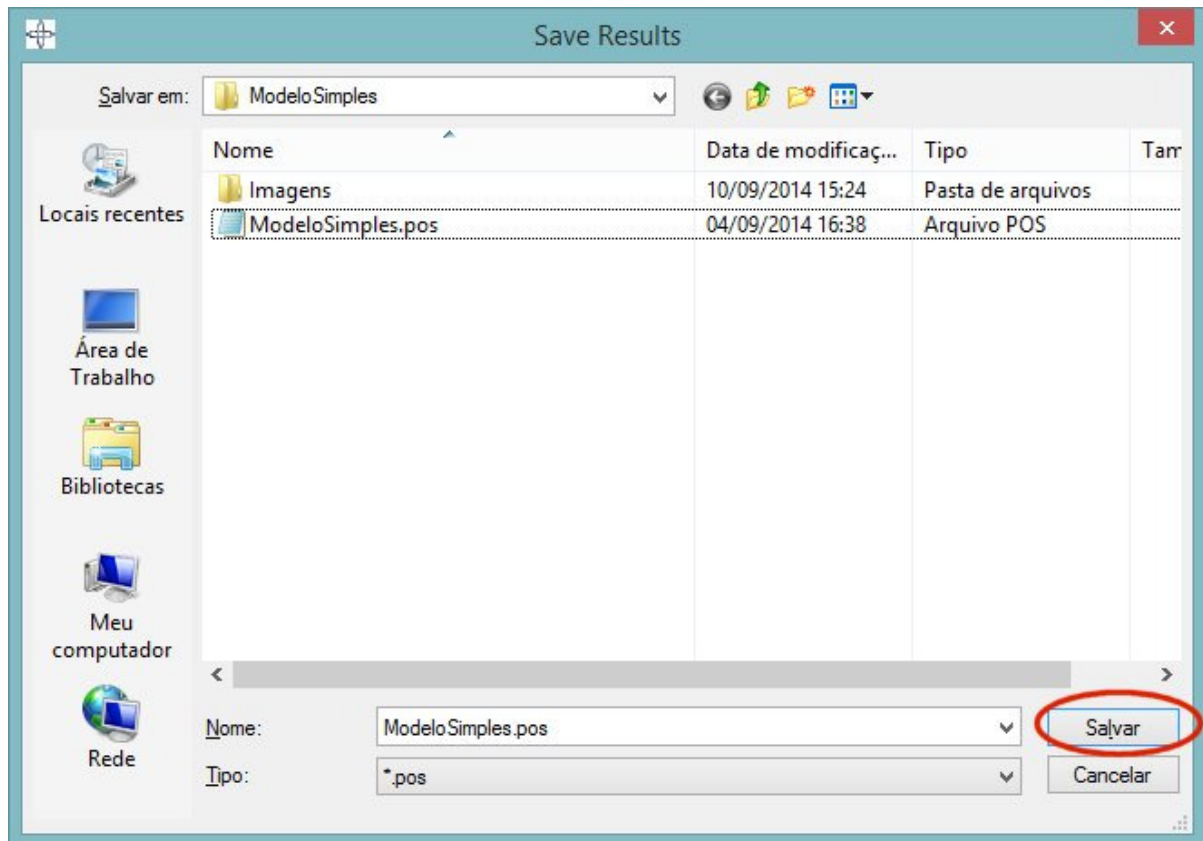



### Primeiro resultado

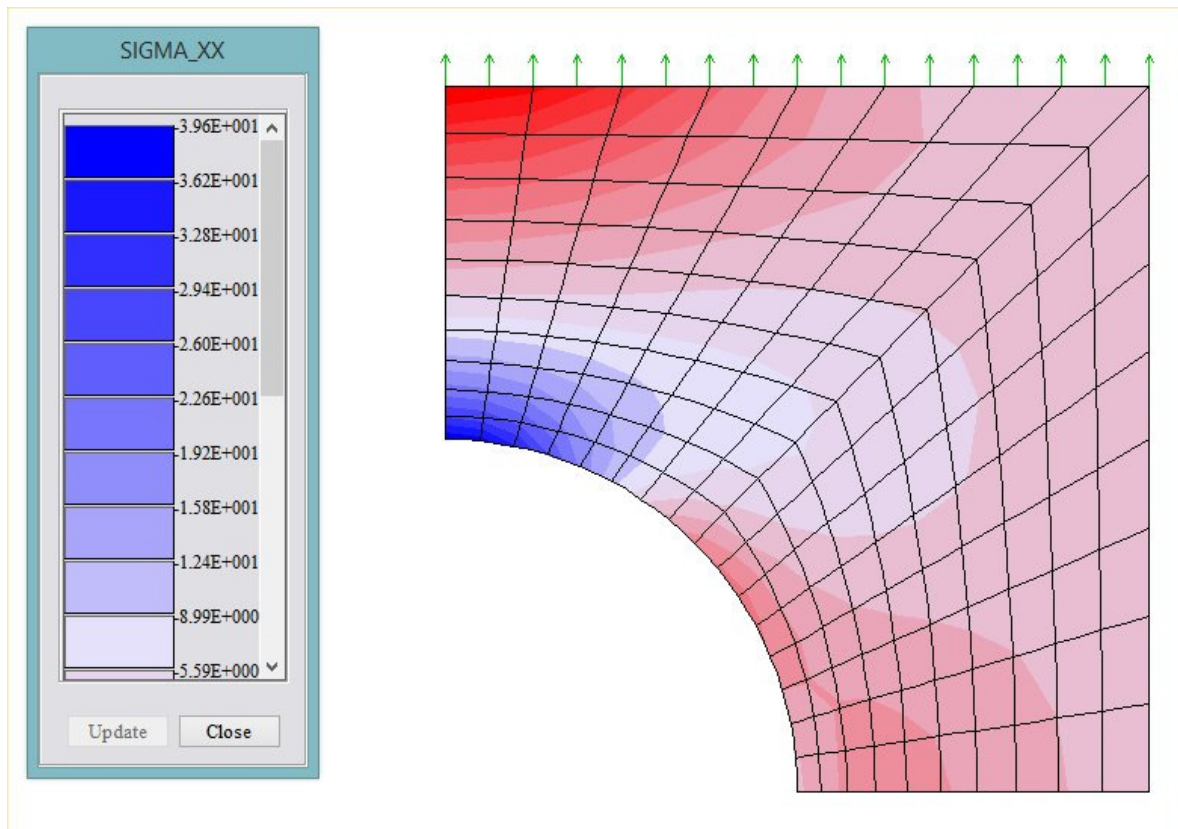

### Habilitar exibição de nós do modelo

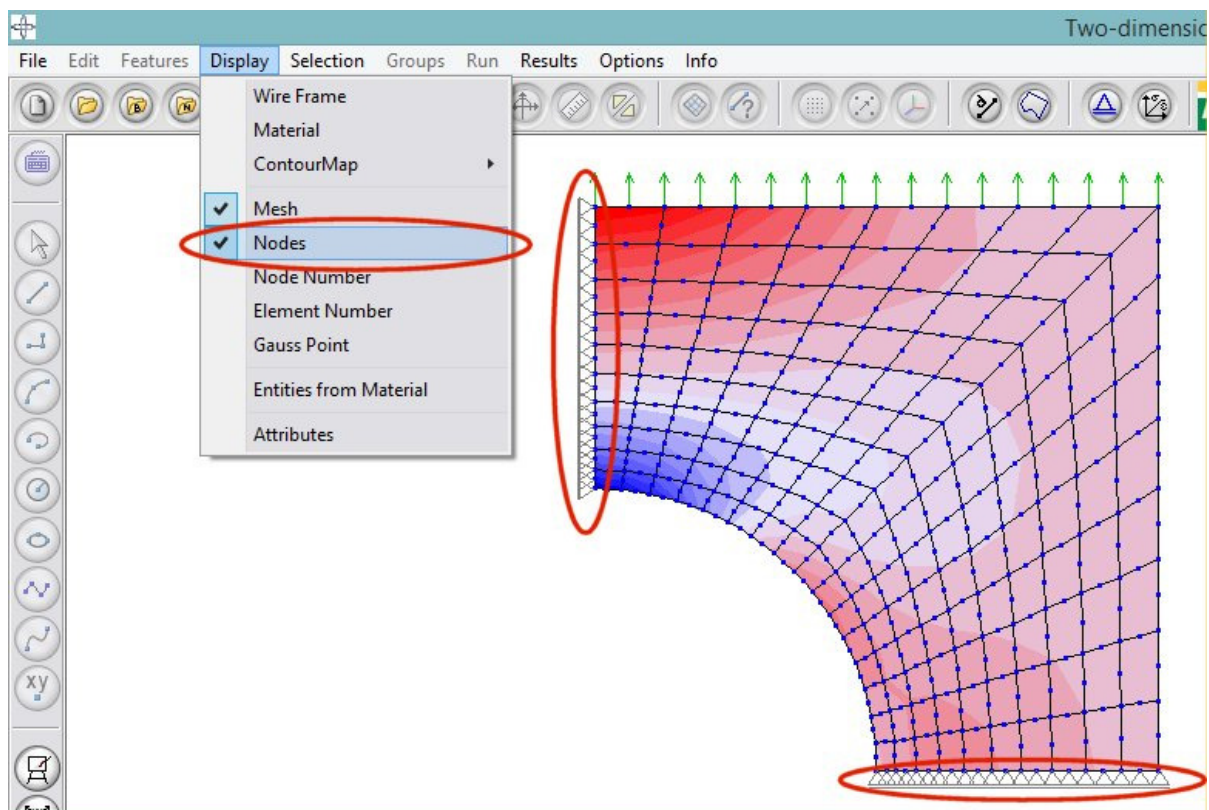





# Modelo final

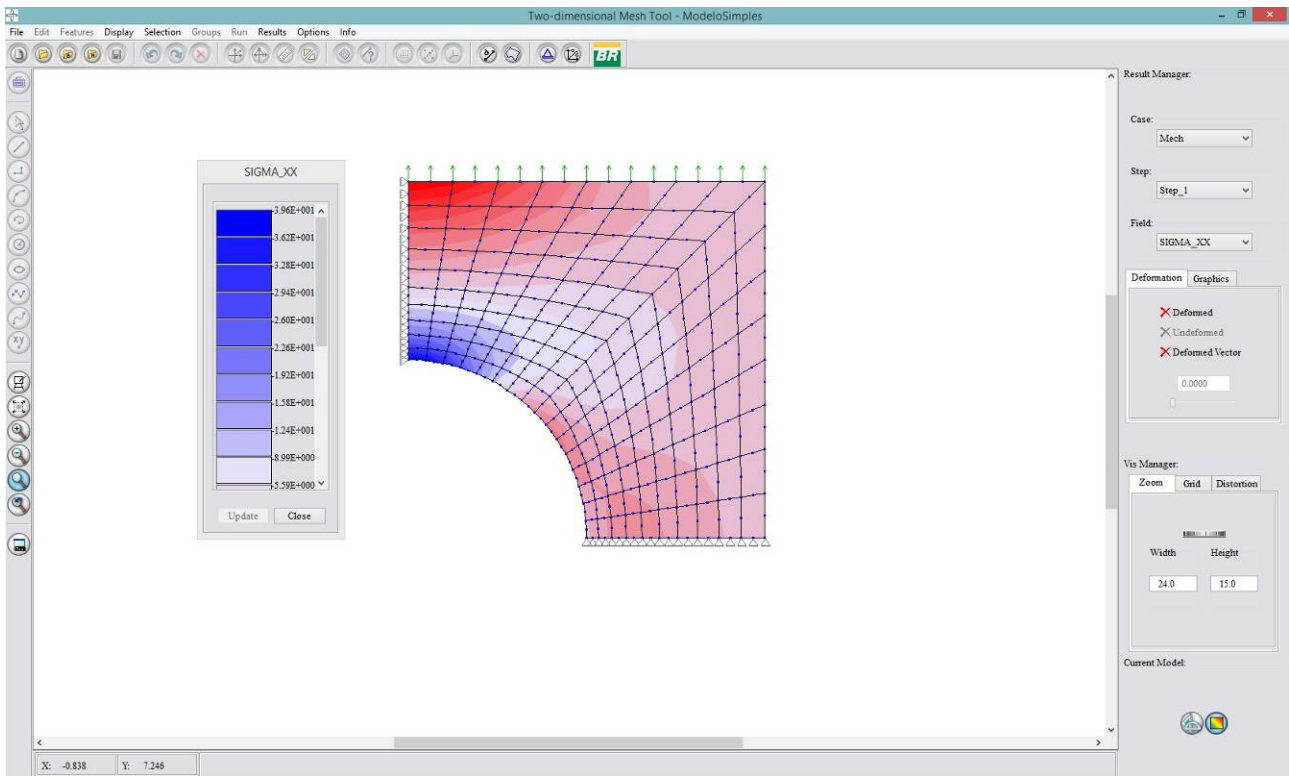



# Sigma para Abaqus

## Aplicar restrição de deslocamento

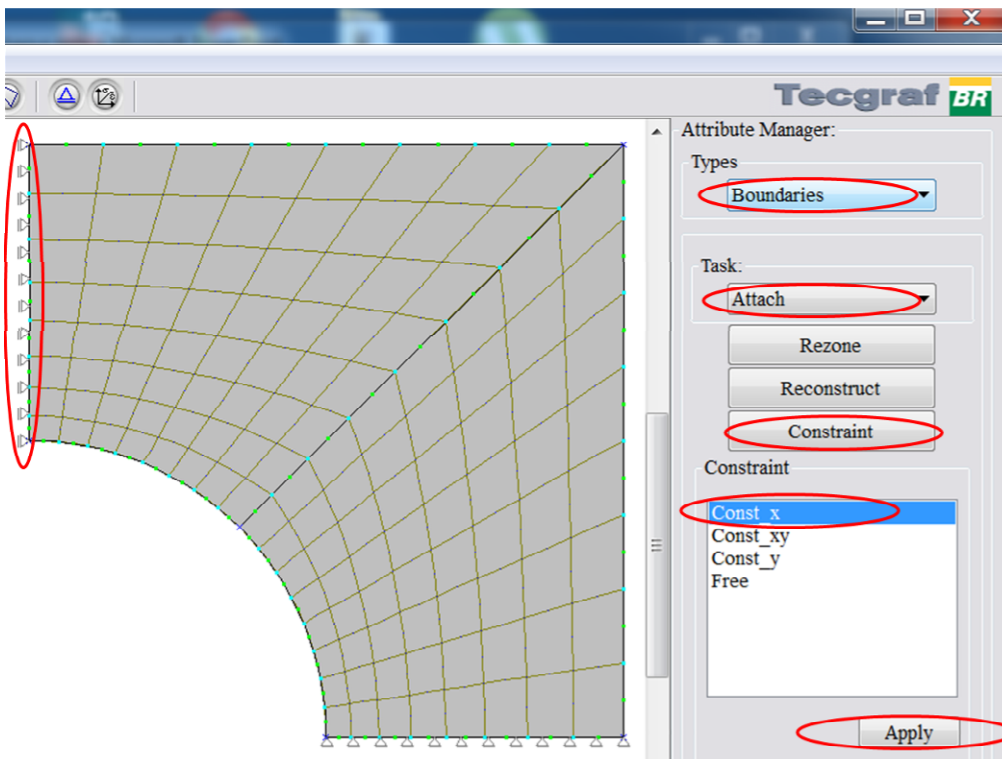
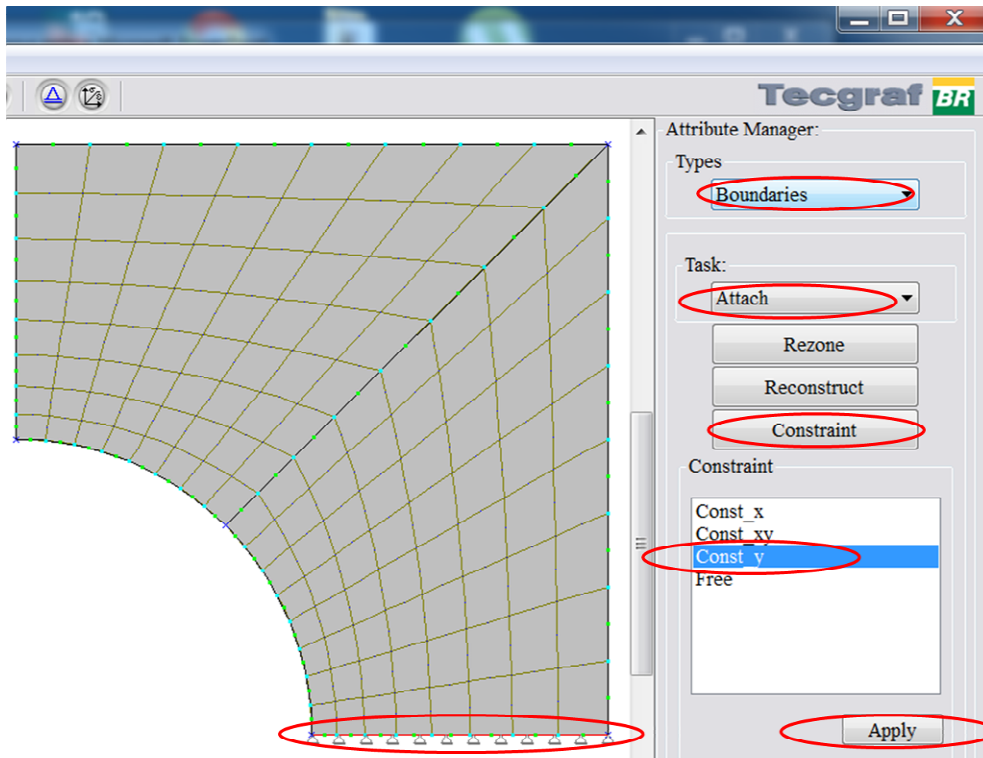



### Aplicar pressão na aresta

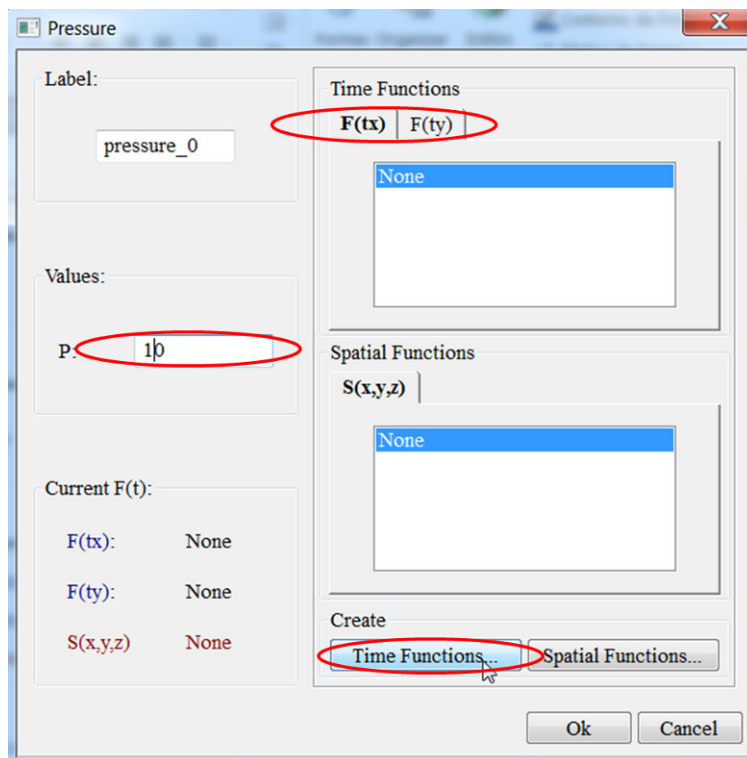
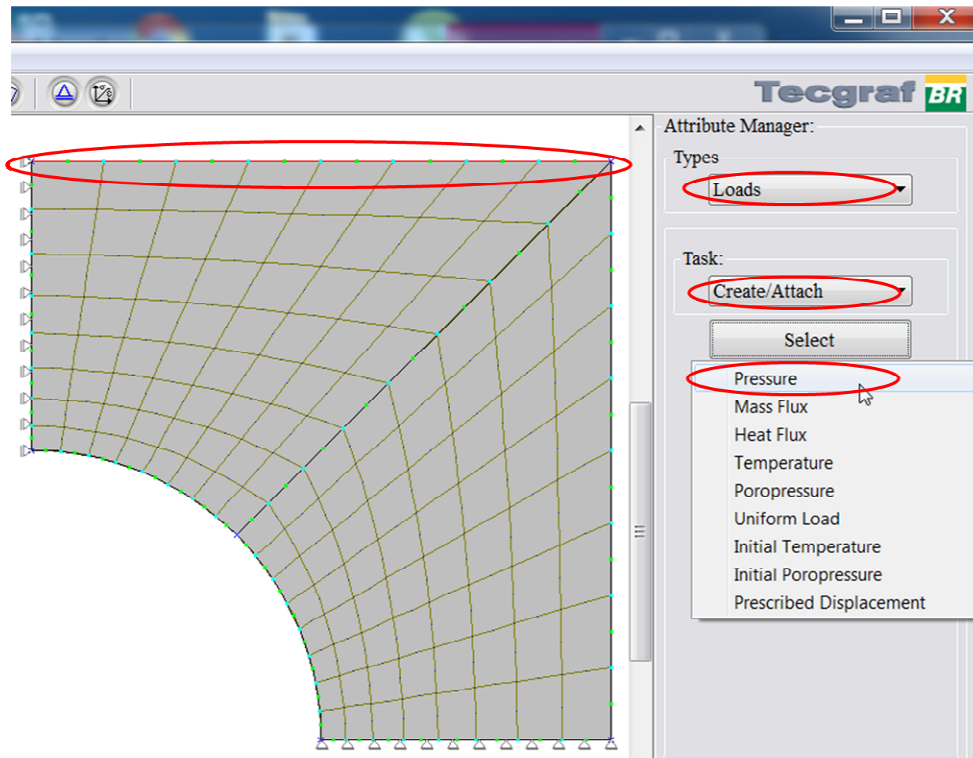



### Aplicar pressão na aresta – criar função de tempo/passo e aplicar em F(x) e F(y)

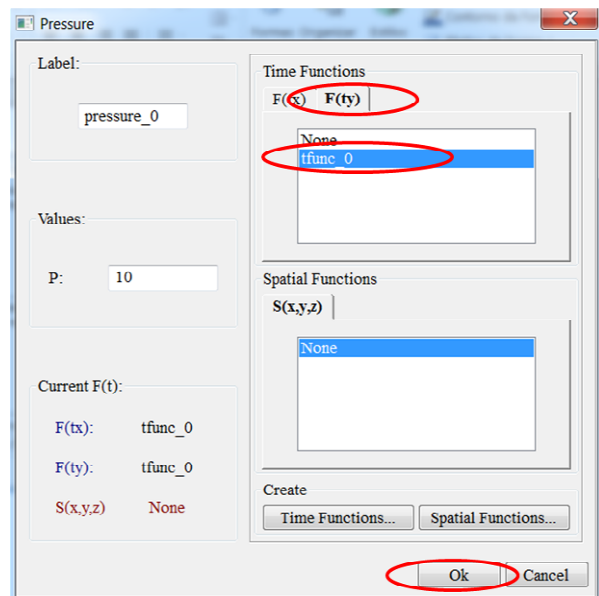
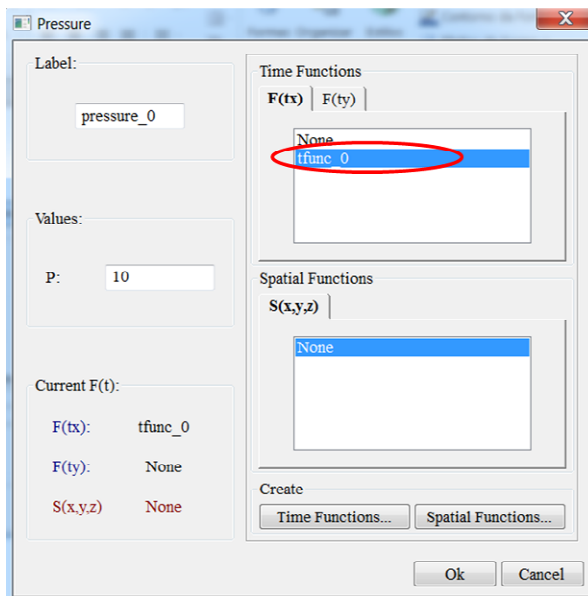
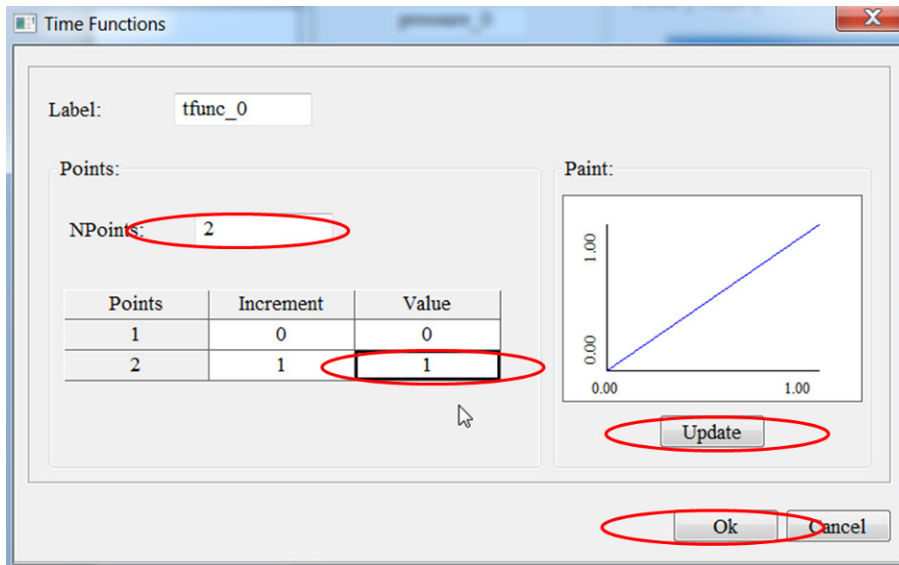



### Visualização da pressão na aresta

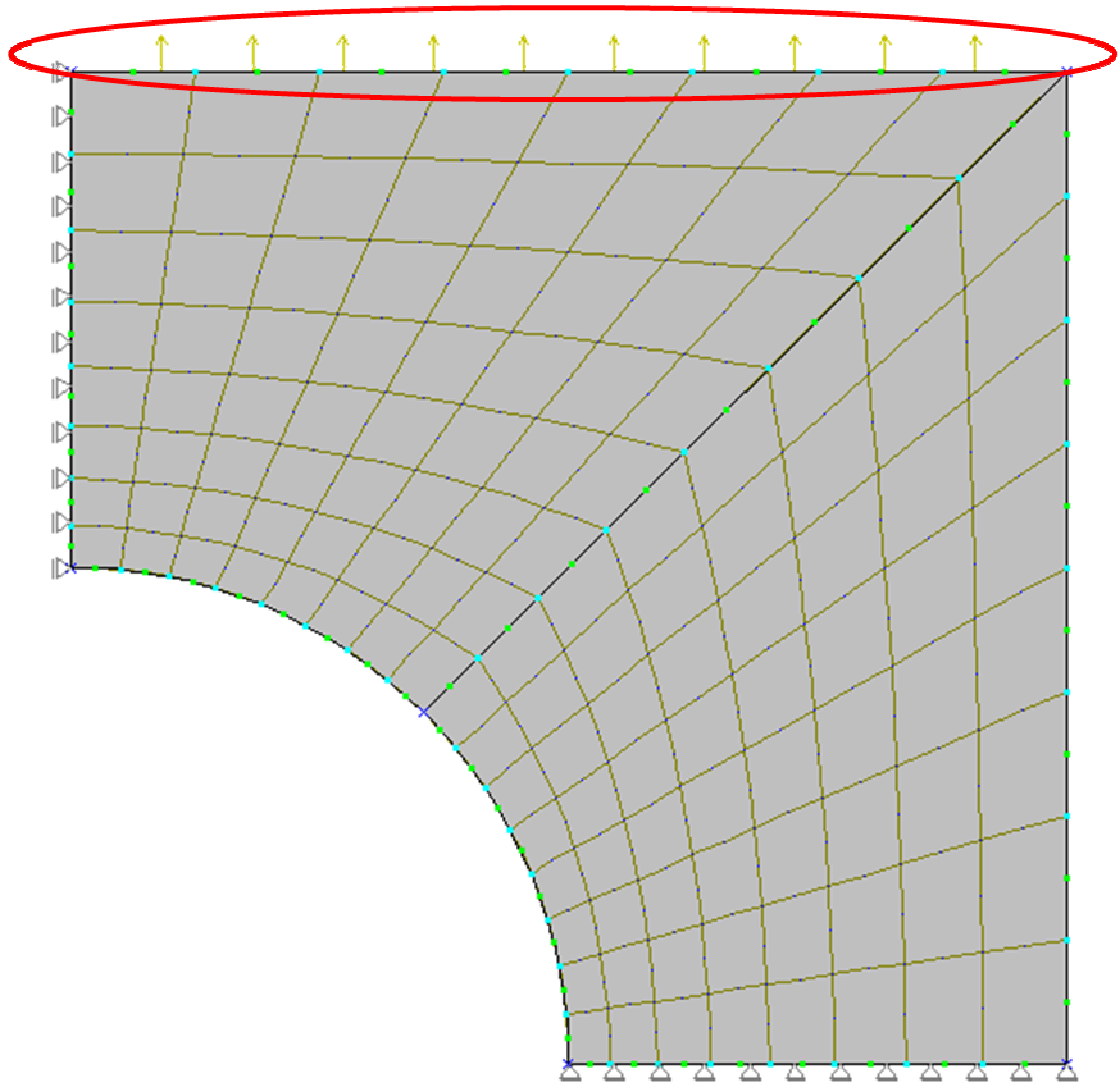



### Criação de material e aplicação de material/propriedade na face

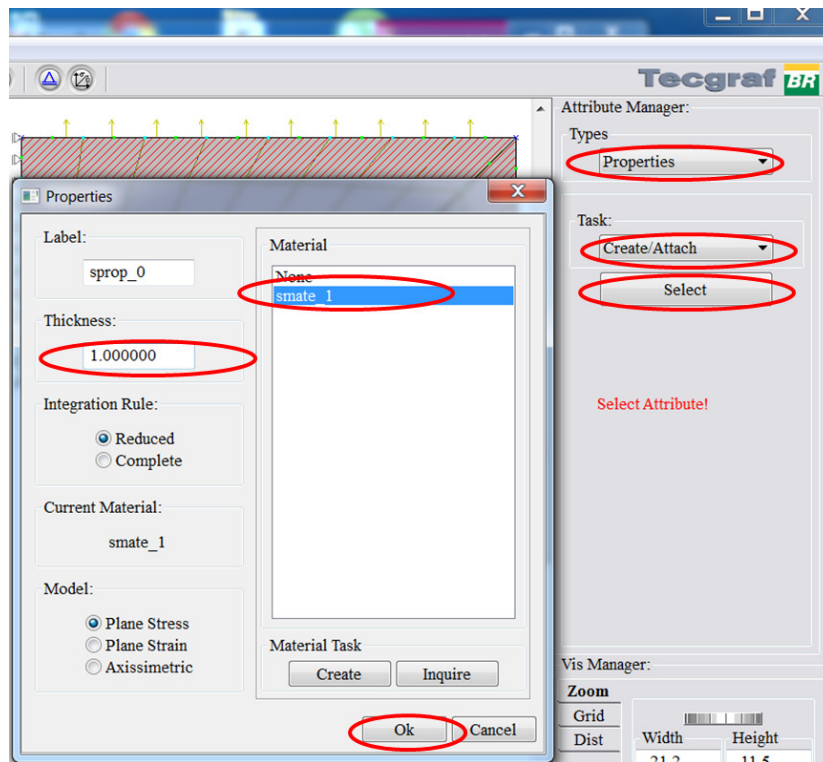
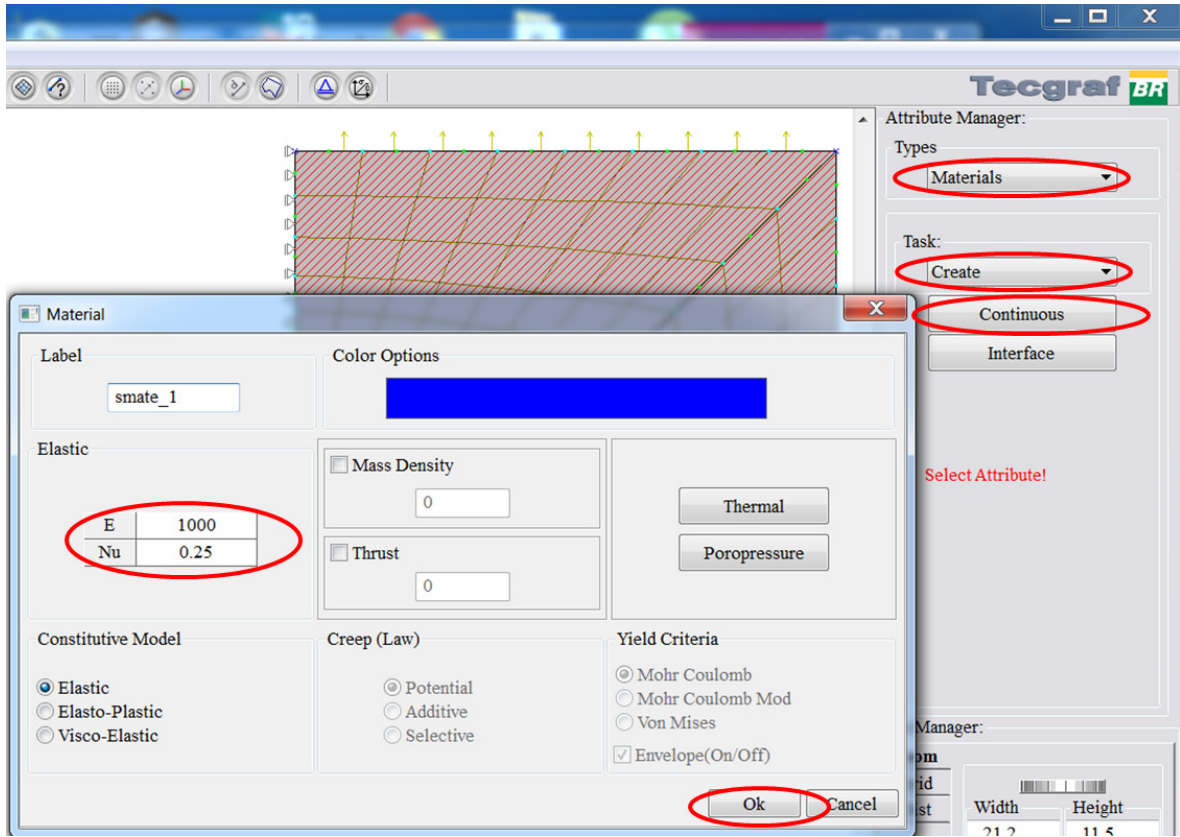



### Ir para o modo de malha

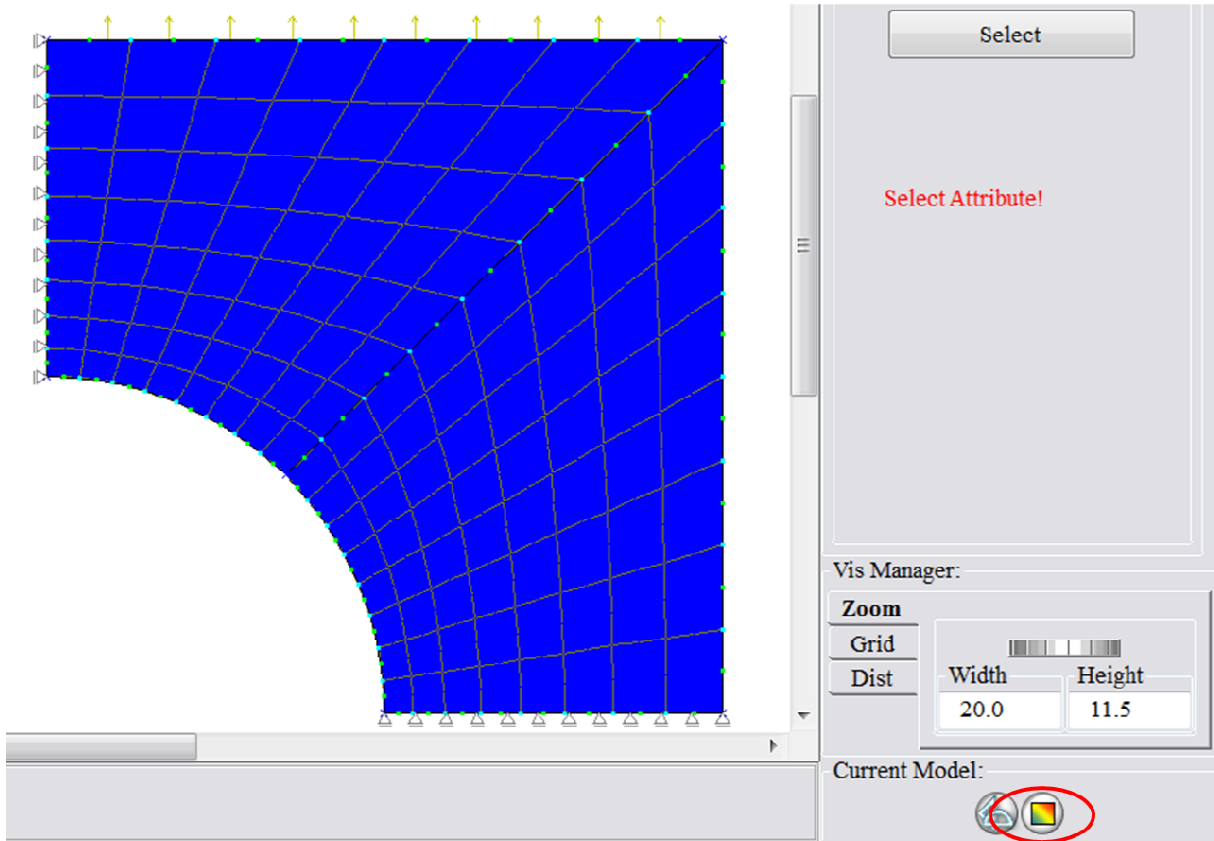

### Exportar modelo para arquivo do Abaqus .inp

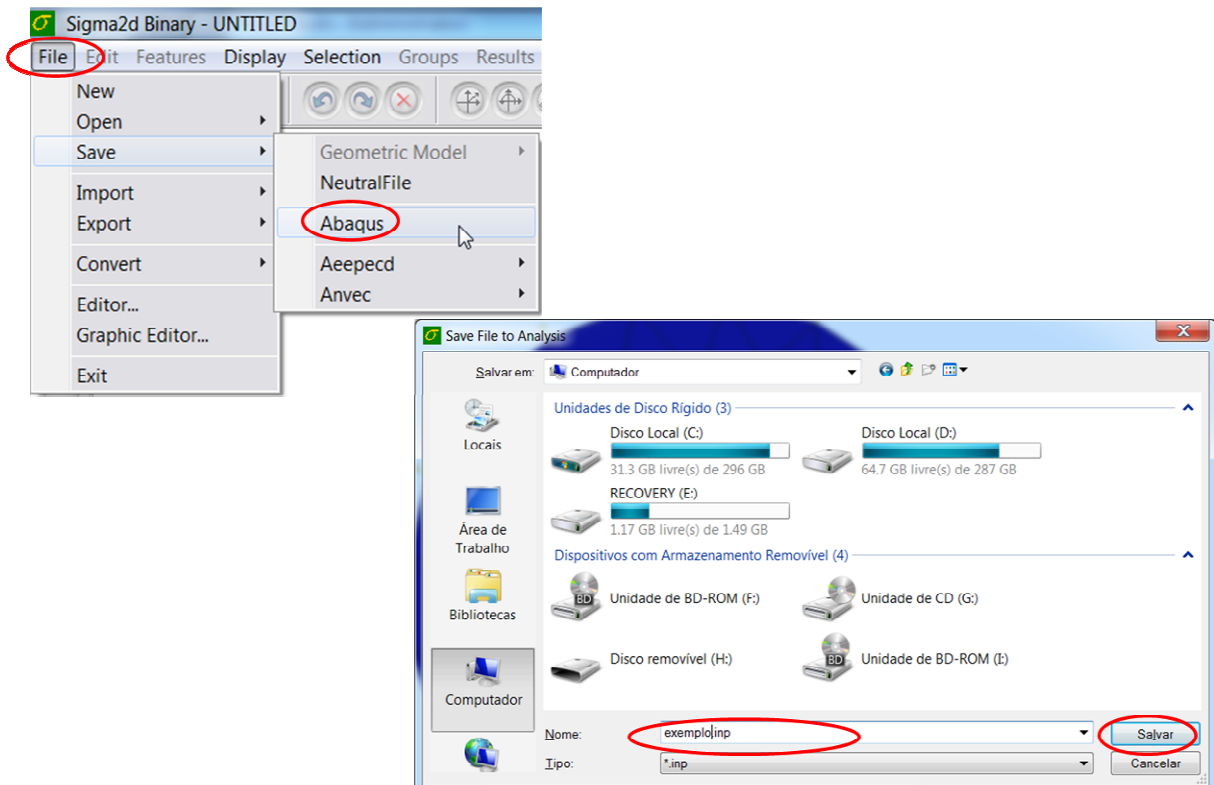



## Importa modelo programa Abaqus/CAE

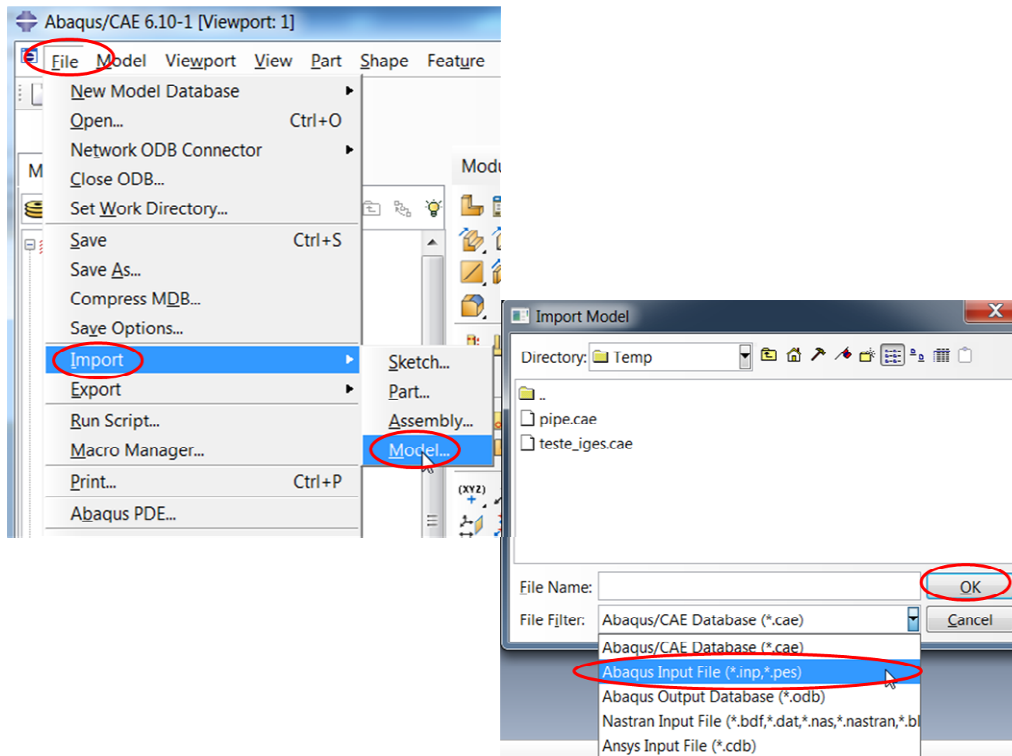

## Verificar se função de carga está correta

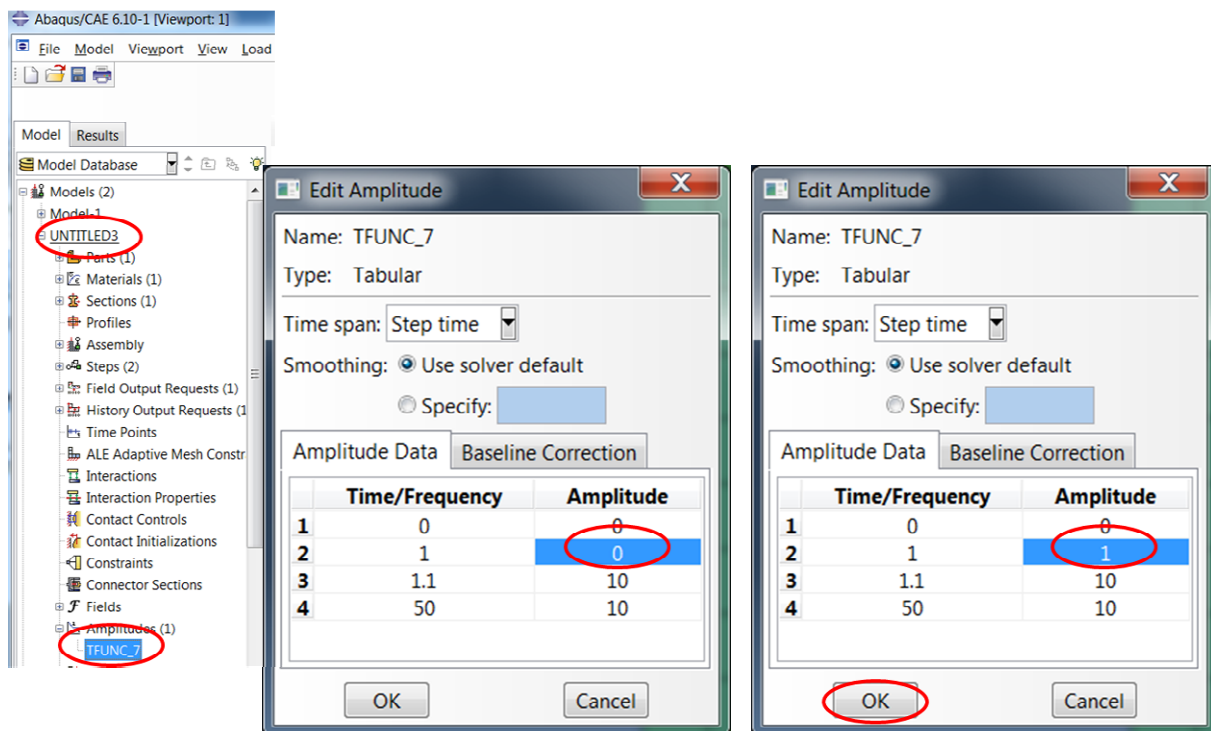





### Criar um “Job” para poder rodar uma análise linear elástica

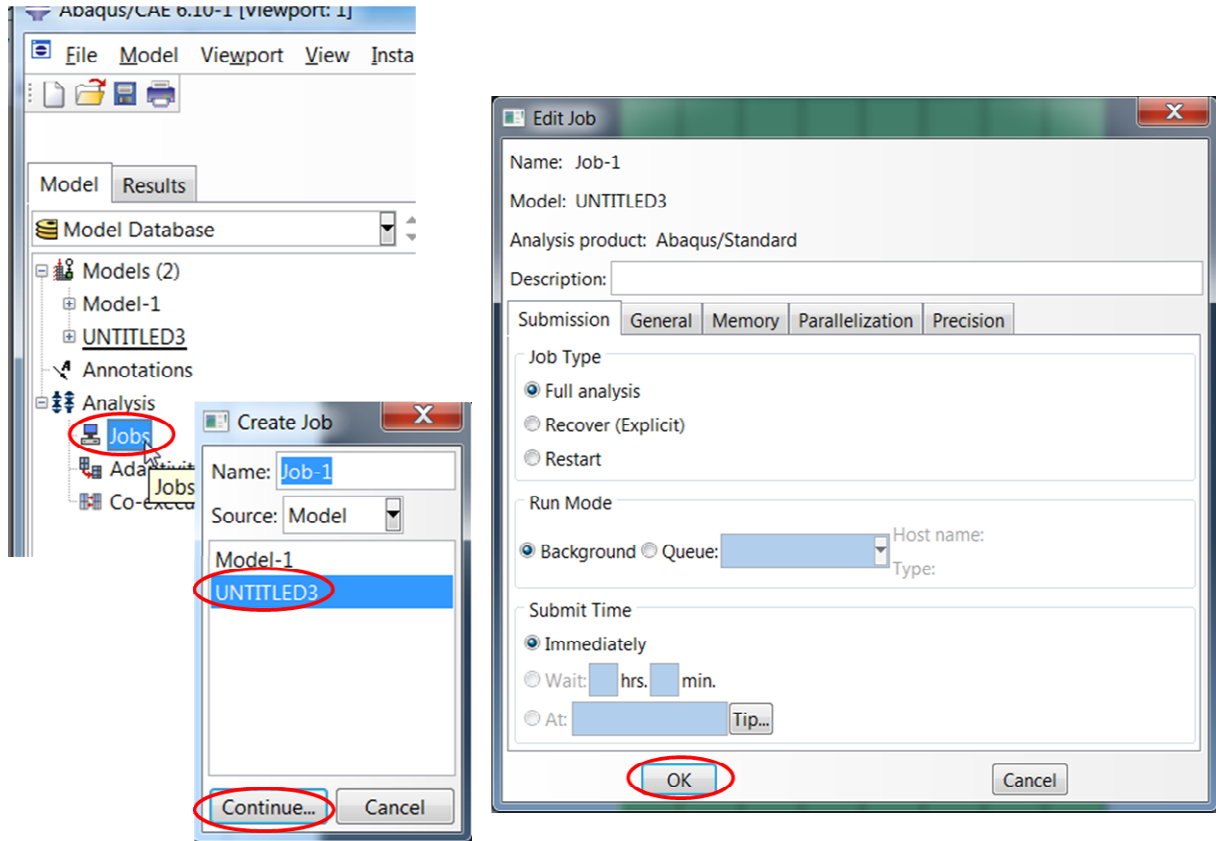

### Submeter análise e depois pedir para visualizar os resultados

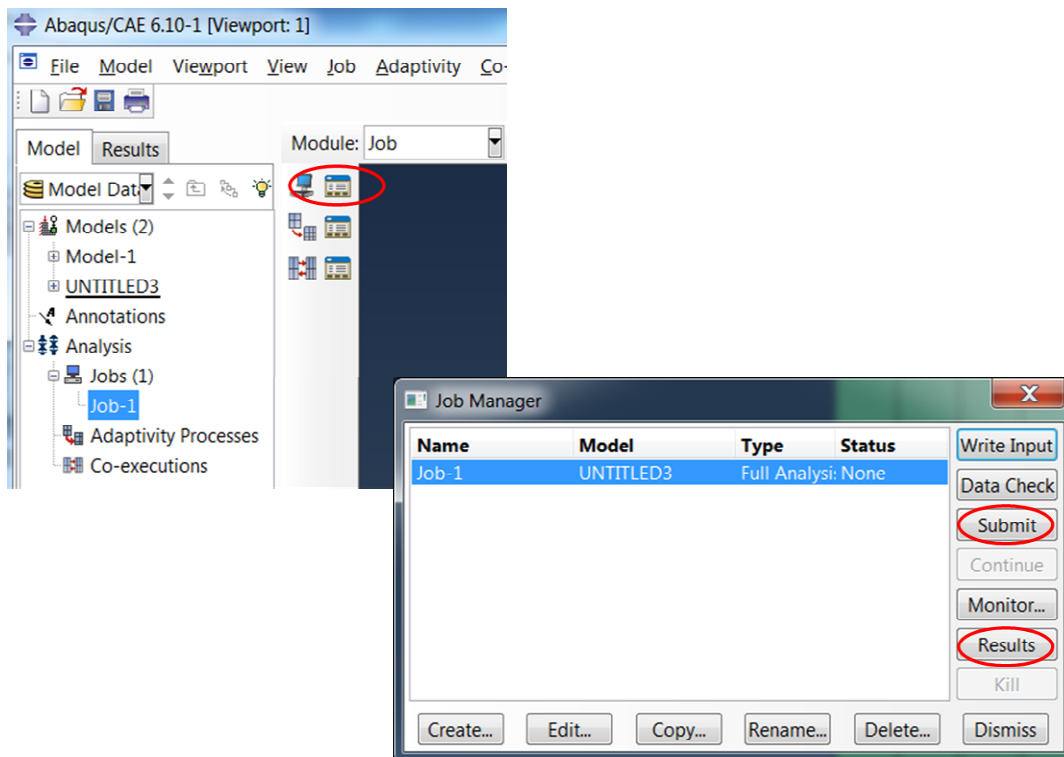



## Visualizar os resultados

