



uff Universidade
Federal
Fluminense

Computer Graphics for Engineering



numsim

Mesh Generation

Luiz Fernando Martha
André Pereira

Graz, Austria
June 2014

Library of mesh generation algorithms

2D structured meshes

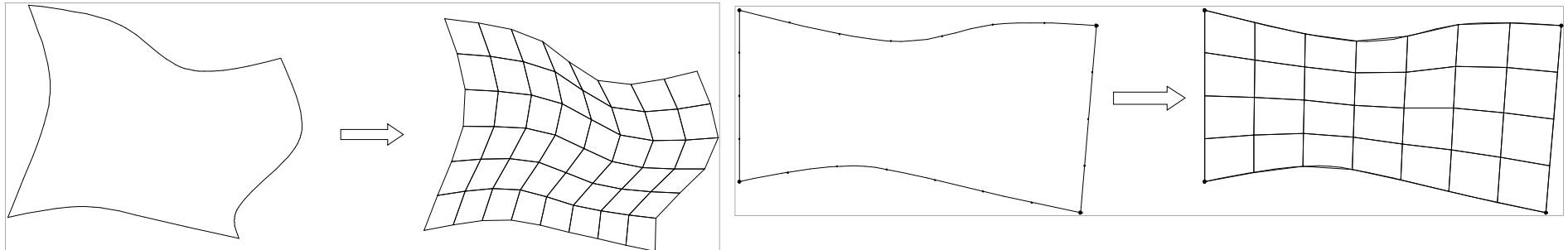

2D structured and non-structured meshes

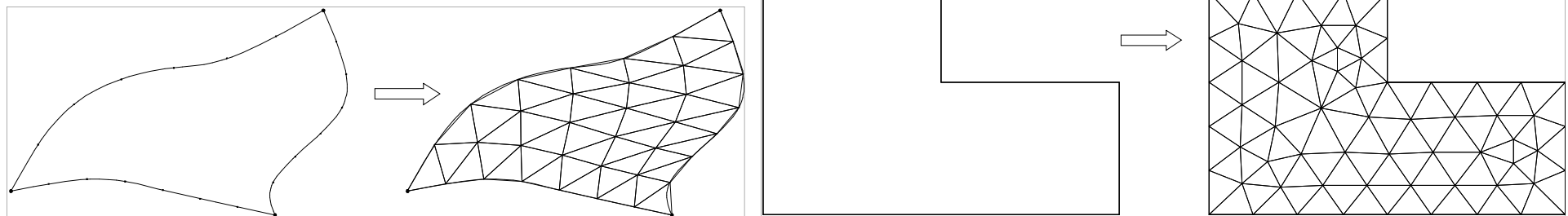

Structured mesh – 2D Mapping



- **Geometry Requirements**
 - 4 topological sides
 - Opposite sides must have similar discretization

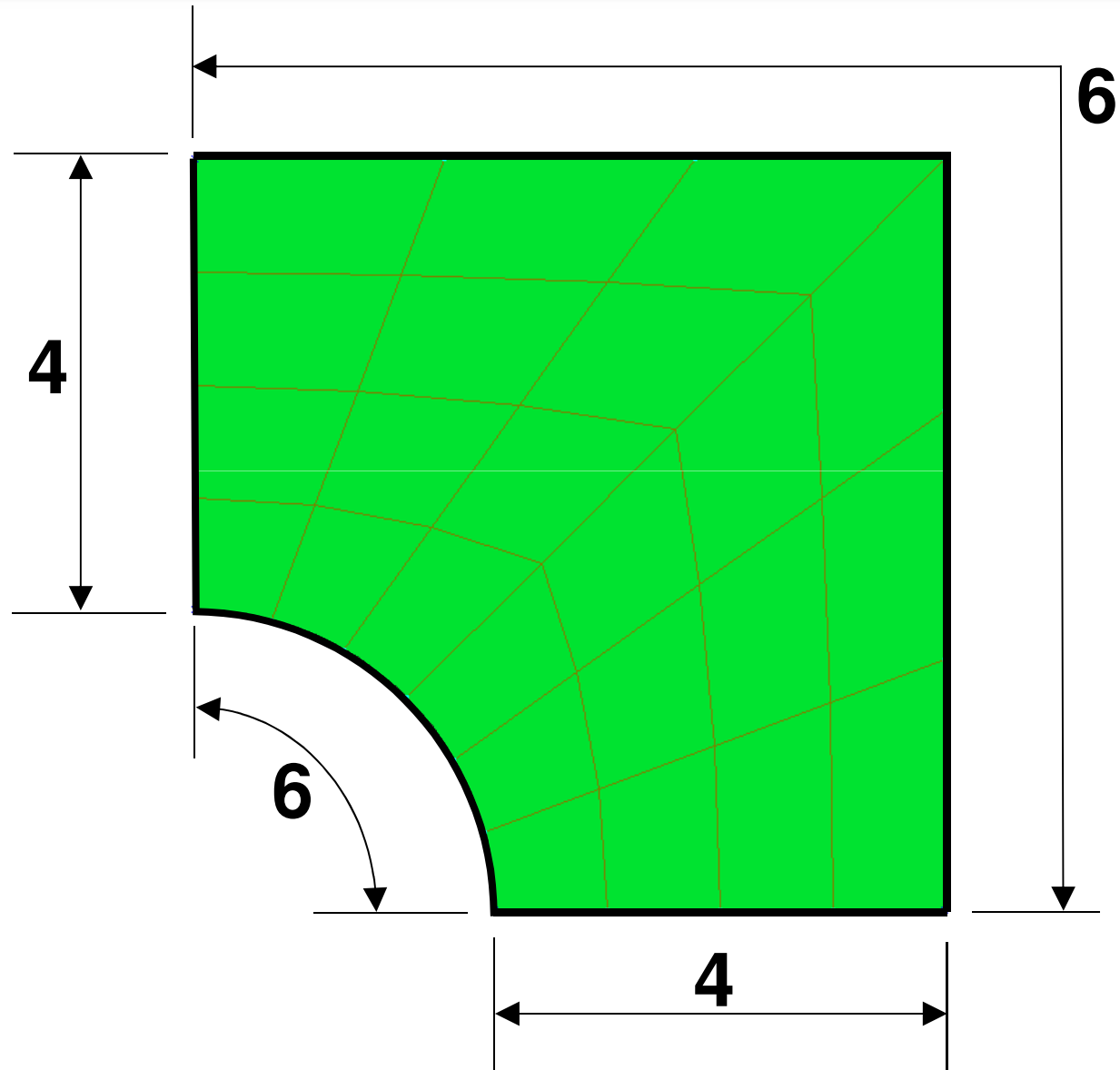



A GENERAL TWO-DIMENSIONAL, GRAPHICAL FINITE ELEMENT PREPROCESSOR UTILIZING DISCRETE TRANSFINITE MAPPINGS

ROBERT HABER‡

University of Illinois, Urbana, Illinois, U.S.A.

MARK S. SHEPHARD‡

Rensselaer Polytechnic Institute, Troy, New York, U.S.A.

JOHN F. ABEL§

Cornell University, Ithaca, New York, U.S.A.

RICHARD H. GALLAGHER||

University of Arizona, Tucson, Arizona, U.S.A.

AND

DONALD P. GREENBERG¶

Cornell University, Ithaca, New York, U.S.A.

Structured mesh – 2D Mapping

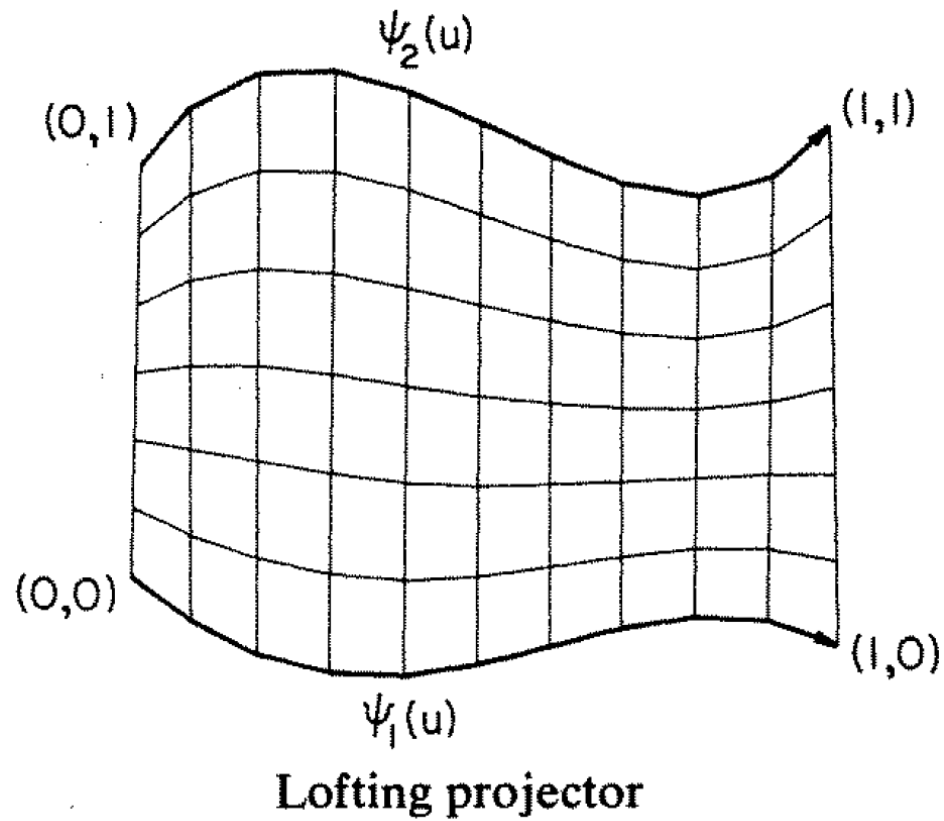

$$\mathcal{P}_1[F] \equiv P_2(u, v) = (1 - v)\psi_1(u) + v\psi_2(u) \quad 0 \leq u \leq 1$$

Structured mesh – 2D Mapping

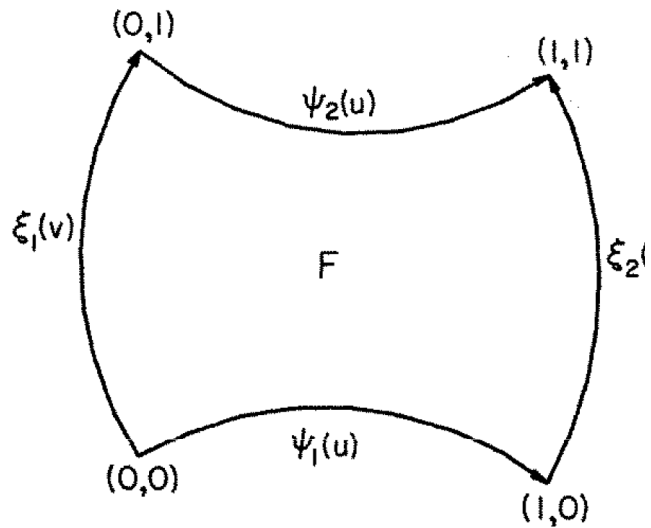

Bilinear projector: co-ordinate system and boundary curves

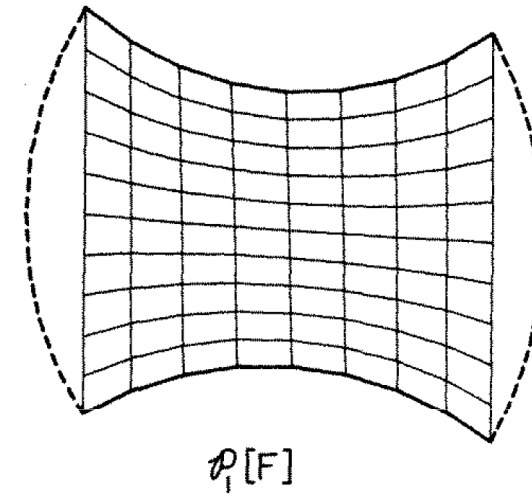

Bilinear projector: \mathcal{P}_1

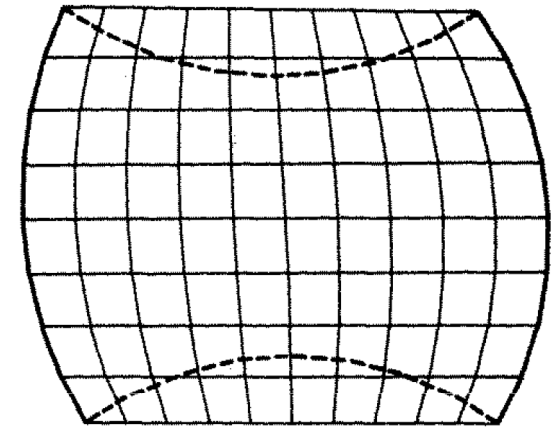

$\mathcal{P}_2[F]$
Bilinear projector: \mathcal{P}_2

$$\mathcal{P}_1[F] \equiv P_2(u, v) = (1 - v)\psi_1(u) + v\psi_2(u) \quad 0 \leq u \leq 1$$

$$\mathcal{P}_2[F] \equiv P_2(u, v) = (1 - u)\xi_1(v) + u\xi_2(v) \quad 0 \leq v \leq 1$$

Structured mesh – 2D Mapping

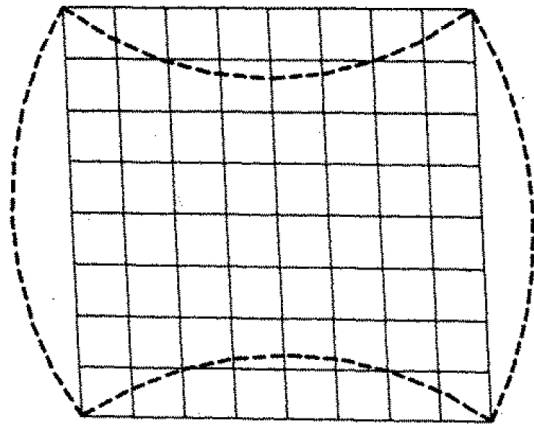

$$\mathcal{P}_1\mathcal{P}_2[F]$$

Bilinear projector: $\mathcal{P}_1\mathcal{P}_2$

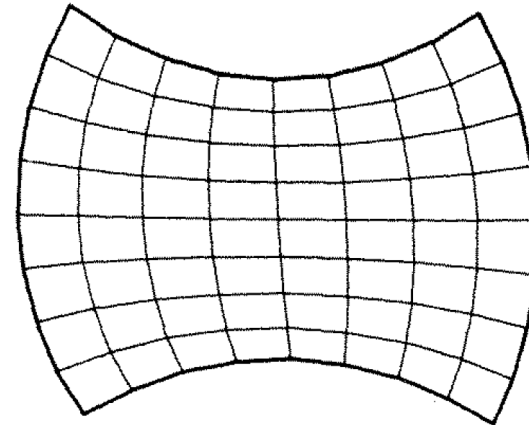

$$\mathcal{P}_1 \oplus \mathcal{P}_2$$

Bilinear projector: $\mathcal{P}_1 \oplus \mathcal{P}_2$

$$(\mathcal{P}_1 \oplus \mathcal{P}_2)[F] \equiv \mathcal{P}_1[F] + \mathcal{P}_2[F] - \mathcal{P}_1\mathcal{P}_2[F]$$

$$= P_B(u, v)$$

$$= (1-v)\psi_1(u) + v\psi_2(u) + (1-u)\xi_1(v) + u\xi_2(v)$$

$$- (1-u)(1-v)F(0, 0) - (1-u)vF(0, 1)$$

$$- uvF(1, 1) - u(1-v)F(1, 0) \quad 0 \leq u \leq 1, 0 \leq v \leq 1$$

Assumed discrete representation of curves:

$$\{\xi_1(v_i), \xi_2(v_i)\} i = 1, n,$$

$$\{\psi_1(u_j), \psi_2(u_j)\} j = 1, m$$

Structured mesh – 2D Mapping

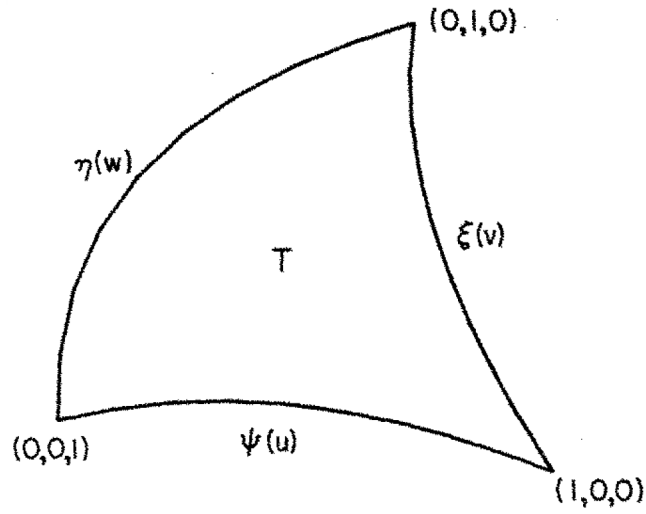

Trilinear projector: co-ordinate system and boundary curves

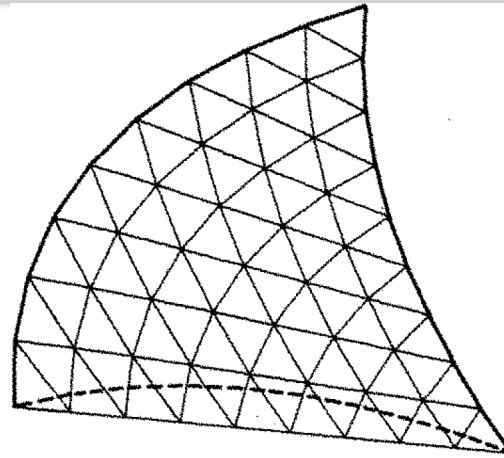

$\eta_1[T]$
Trilinear projector: \mathcal{N}_1

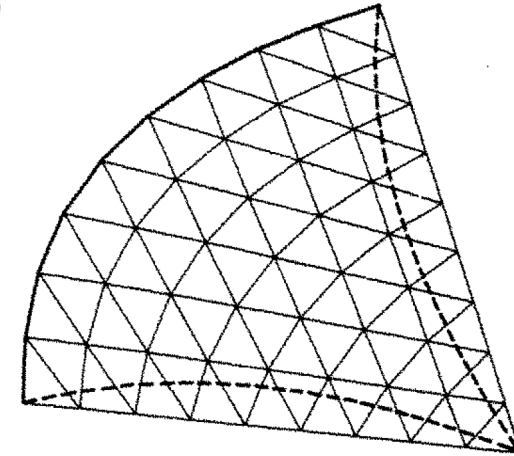

$\eta_1, \eta_2[T]$
Trilinear projector: $\mathcal{N}_1, \mathcal{N}_2$

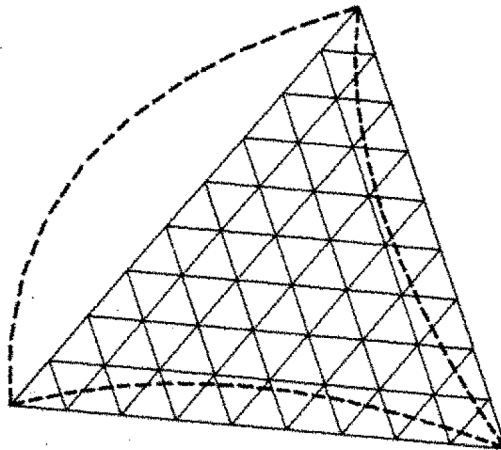

$\eta_1, \eta_2, \eta_3[T]$
Trilinear projector: $\mathcal{N}_1, \mathcal{N}_2, \mathcal{N}_3$

$$\mathcal{N}_1 \equiv N_1(u, v, w) = \left(\frac{u}{1-v} \right) \xi(v) + \left(\frac{w}{1-v} \right) \eta(1-v)$$

$$\mathcal{N}_2 \equiv N_2(u, v, w) = \left(\frac{v}{1-w} \right) \eta(w) + \left(\frac{u}{1-w} \right) \psi(1-w)$$

$$\mathcal{N}_3 \equiv N_3(u, v, w) = \left(\frac{w}{1-u} \right) \psi(u) + \left(\frac{v}{1-u} \right) \xi(1-u)$$

$$0 \leq u \leq 1, \quad 0 \leq v \leq 1, \quad 0 \leq w \leq 1, \quad u + v + w = 1$$

Structured mesh – 2D Mapping

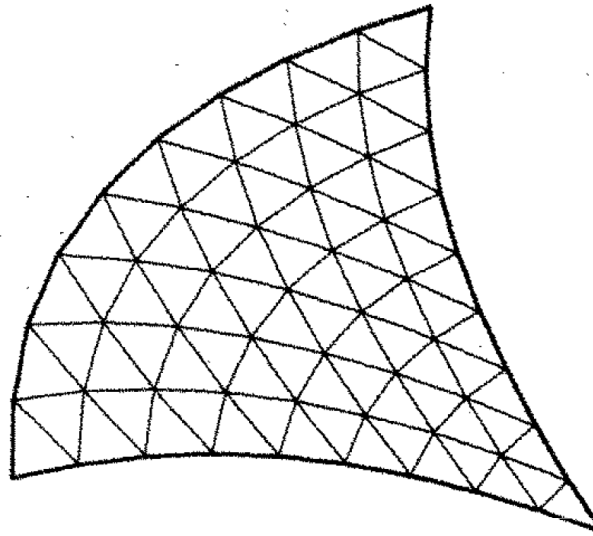

$Q[T]$

Trilinear projector: \mathcal{Q}

$$\begin{aligned} \mathcal{Q} \equiv Q(u, v, w) = & \frac{1}{2} \left[\left(\frac{u}{1-v} \right) \xi(v) + \left(\frac{w}{1-v} \right) \eta(1-v) + \left(\frac{v}{1-w} \right) \eta(w) + \left(\frac{u}{1-w} \right) \psi(1-w) \right. \\ & \left. + \left(\frac{w}{1-u} \right) \psi(u) + \left(\frac{v}{1-u} \right) \xi(1-u) - w\psi(0) - u\xi(0) - v\eta(0) \right] \end{aligned}$$

Assumed discrete representation of curves:

$$\{\psi(u_i), \xi(v_i), \eta(w_i); i = 1, n\}$$

Library of mesh generation algorithms

Quadrilateral template (new)

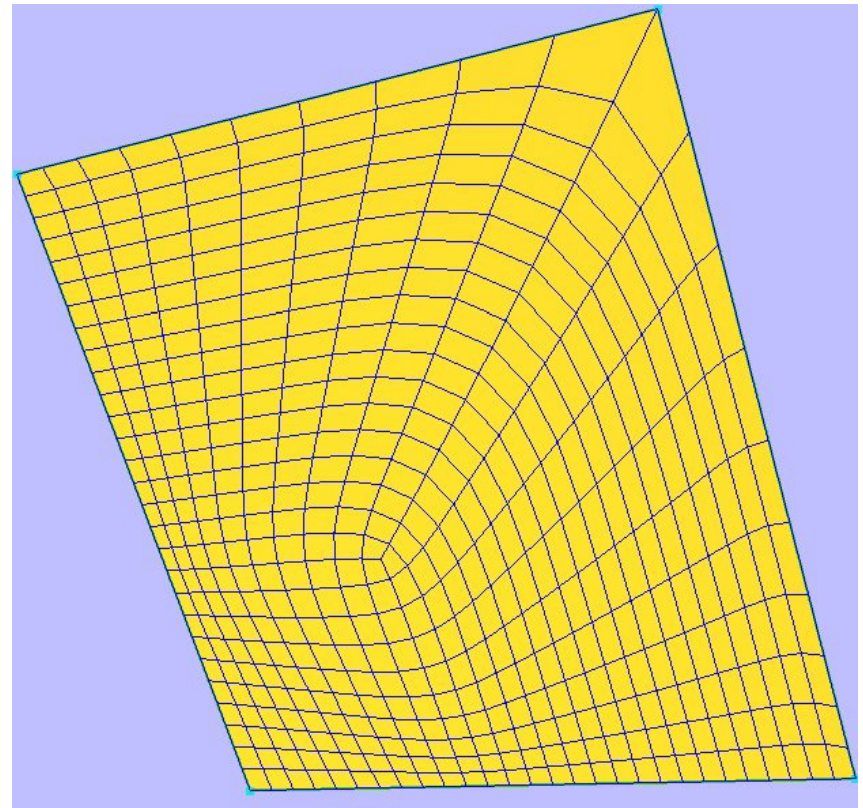
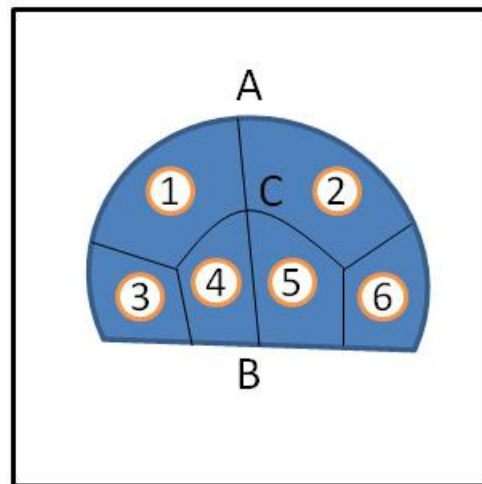
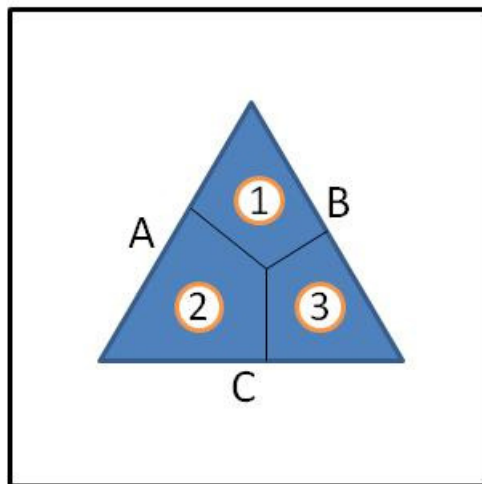
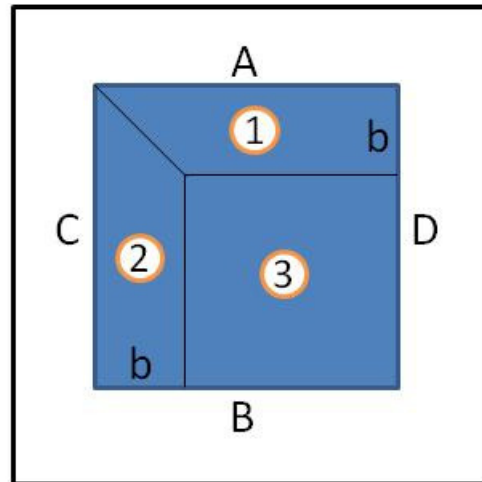
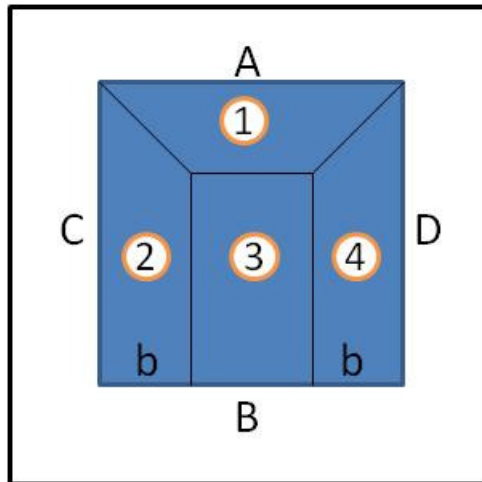

Structured mesh – 3D Mapping

- **Geometry Requirements**
 - 6 topological surfaces
 - Opposite surfaces must have similar mapped meshes

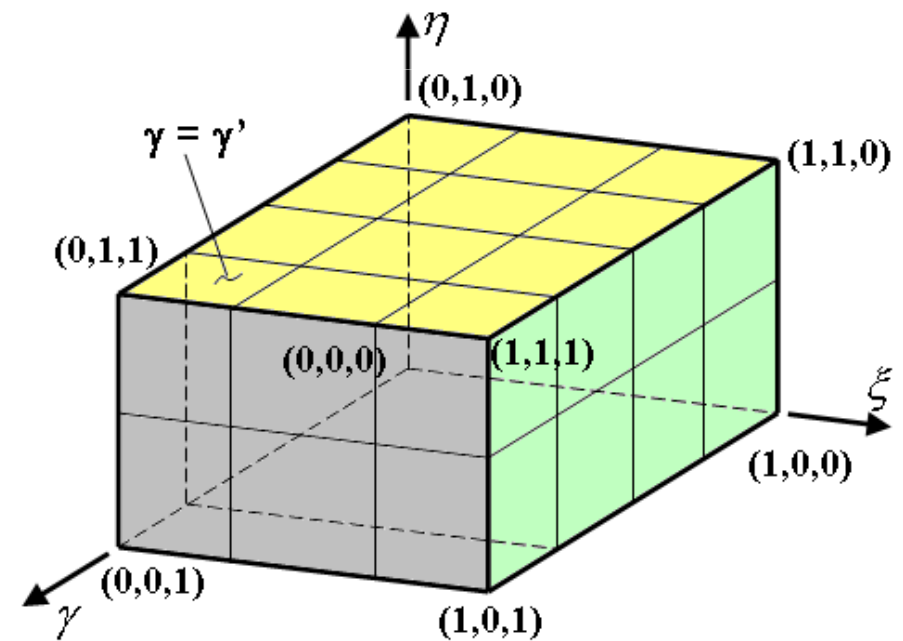
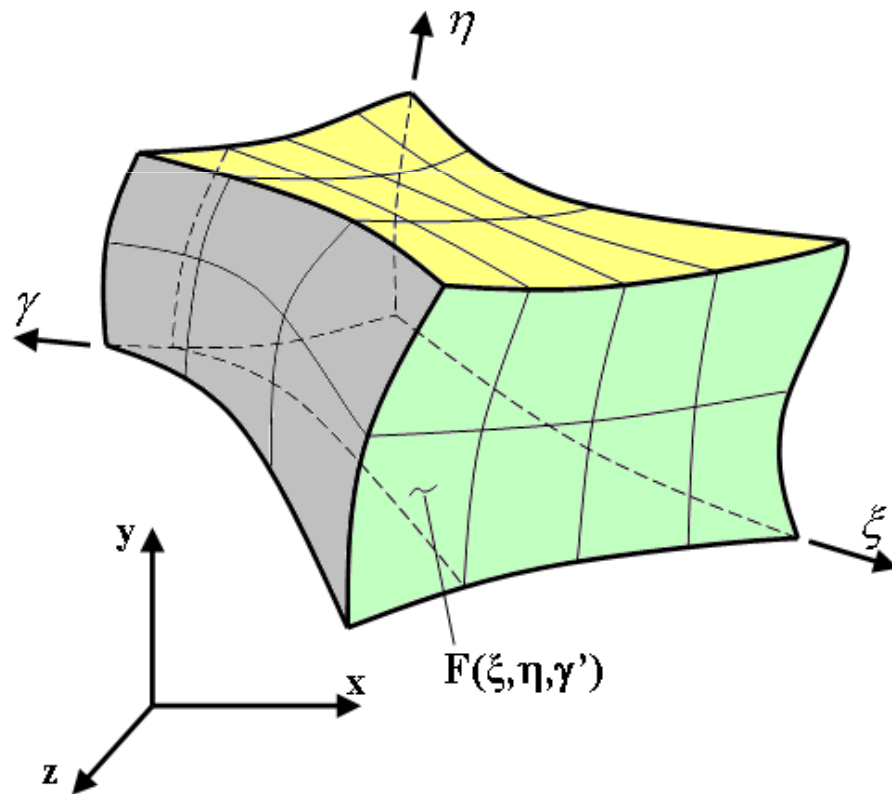

Structured mesh – 3D Mapping



- **Many complex domains can be mapped**

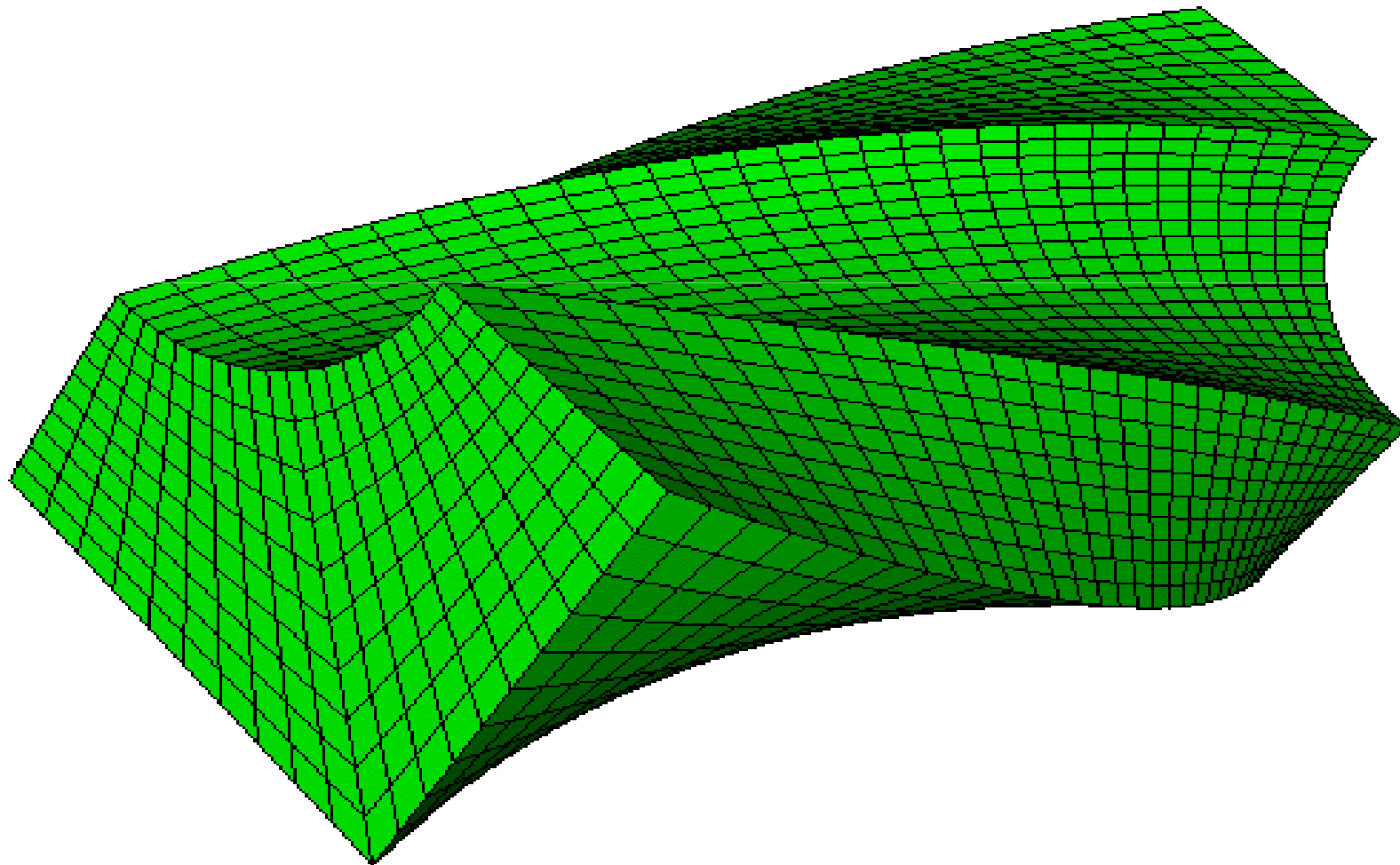

Structured mesh – 3D Mapping



- **Algorithm must deal with:**
 - **Multiple surfaces on boundary**
 - **Concave surfaces**

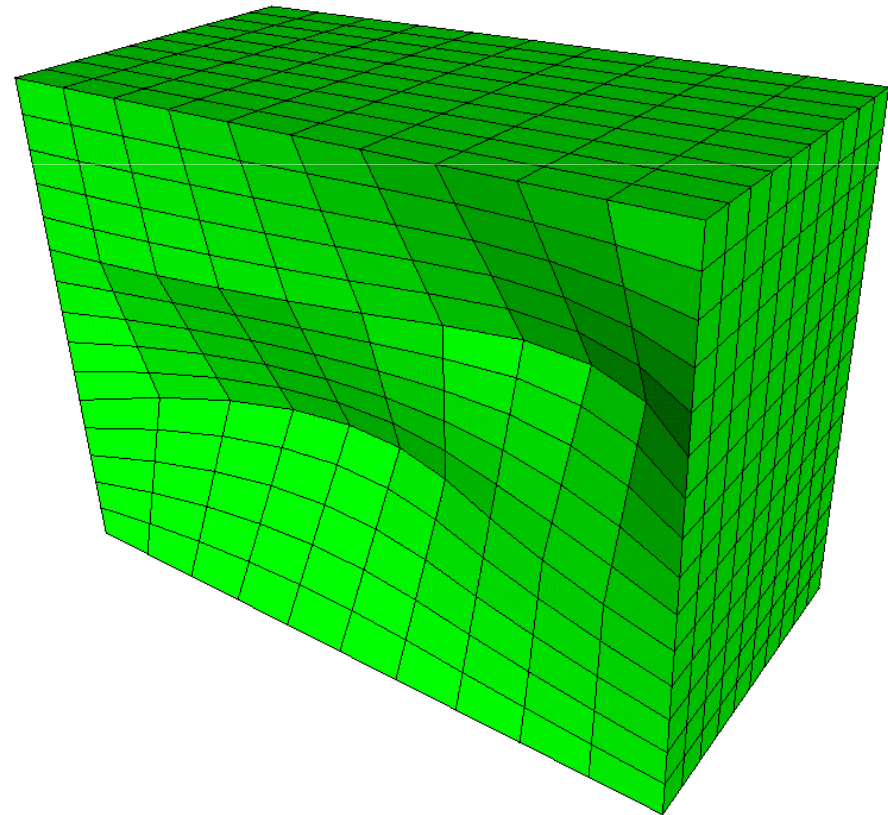
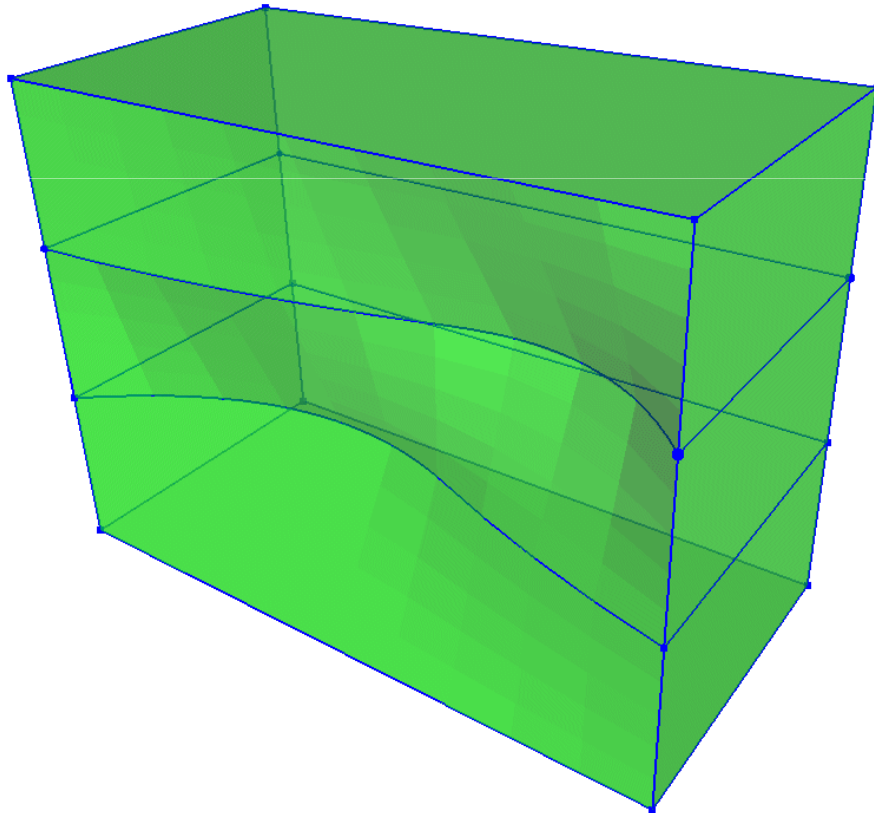

Structured mesh – Sweeping



- **Geometry Requirements**

- Source and target surfaces topologically similar
- Mapped linked surfaces

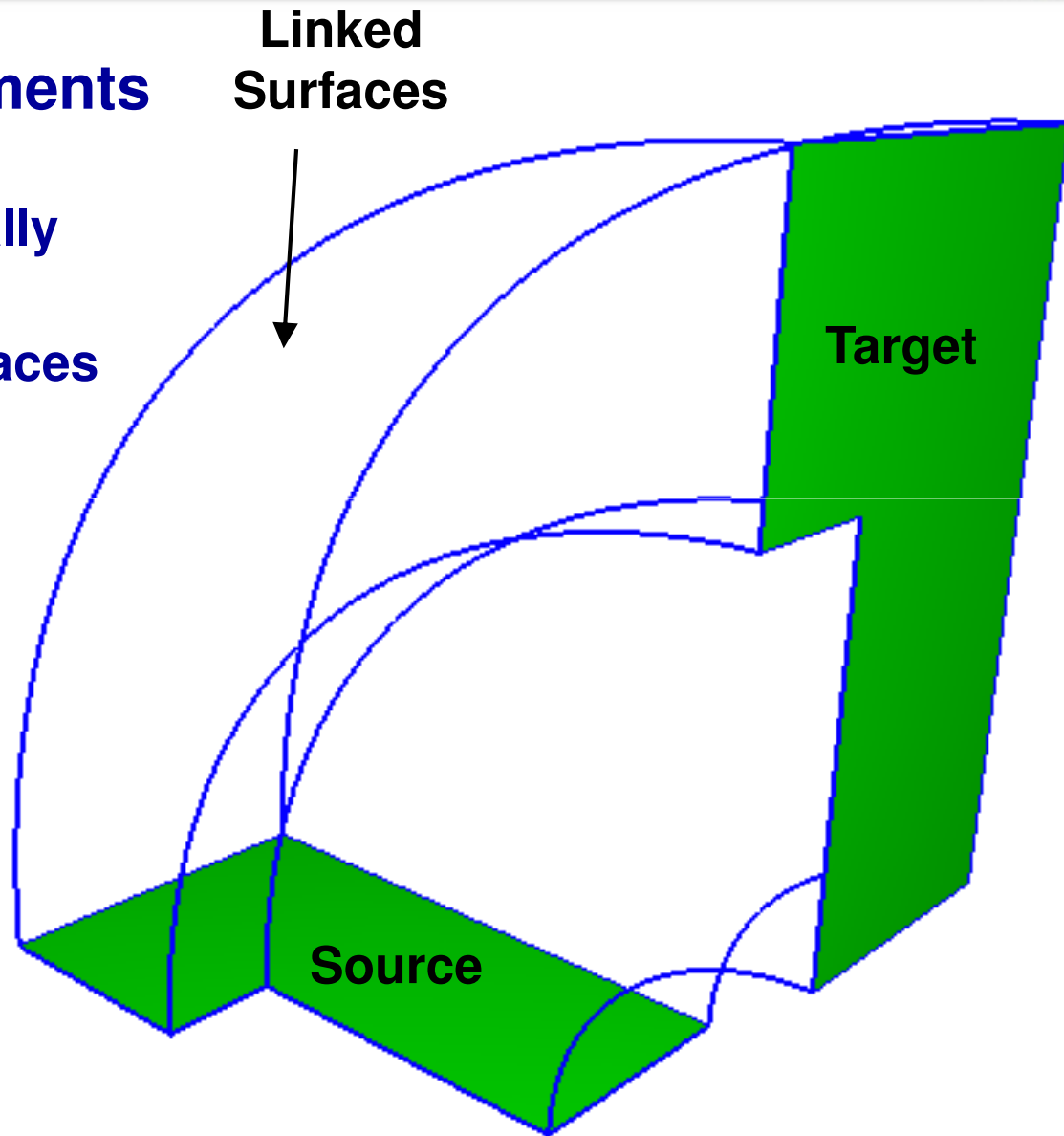

Structured mesh – Sweeping

- **Geometry Requirements**

- **Source and target surfaces topologically similar**
- **Mapped linked surfaces**

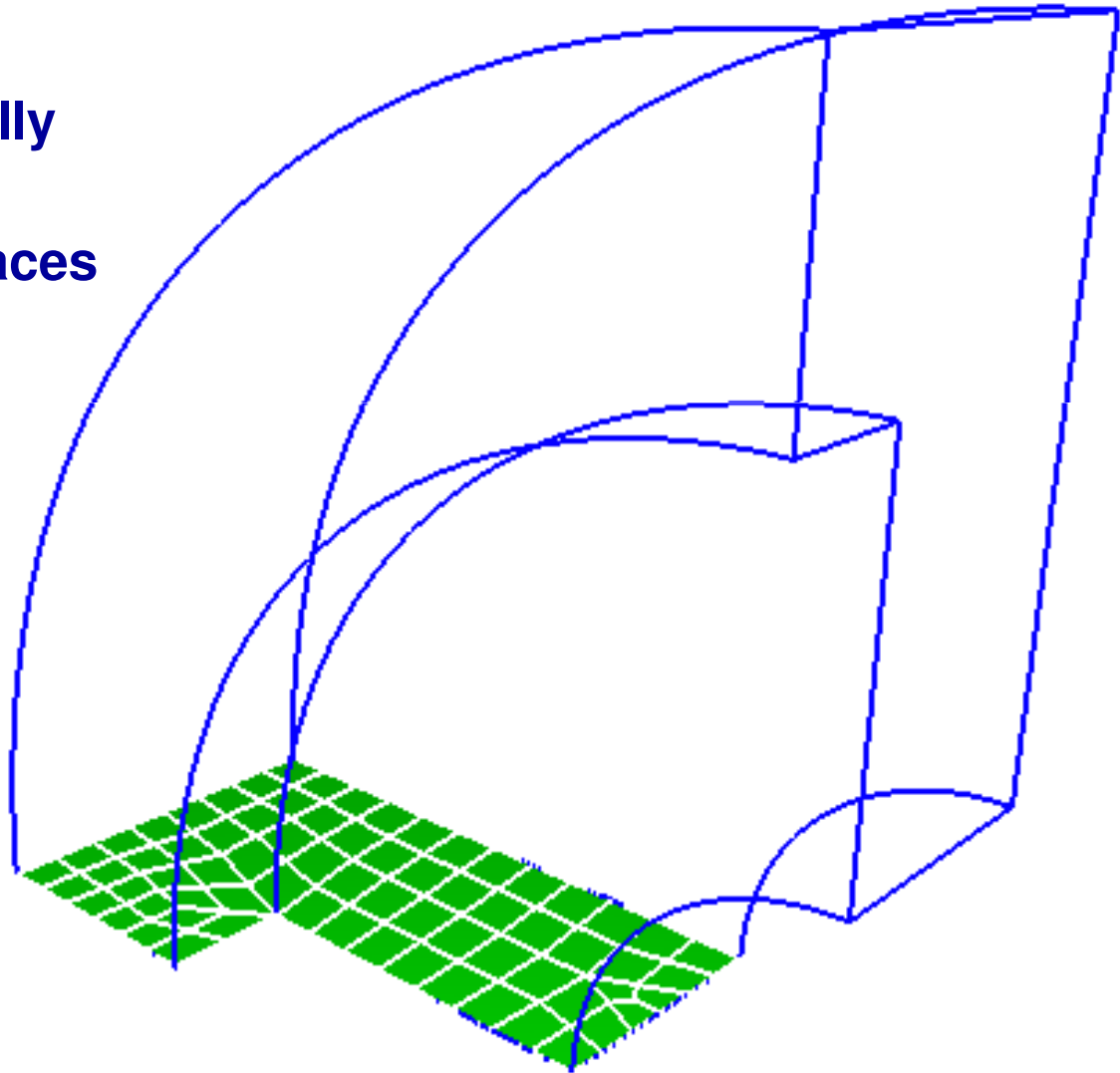

Structured mesh – Sweeping

- **Geometry Requirements**

- Source and target surfaces topologically similar
- Mapped linked surfaces

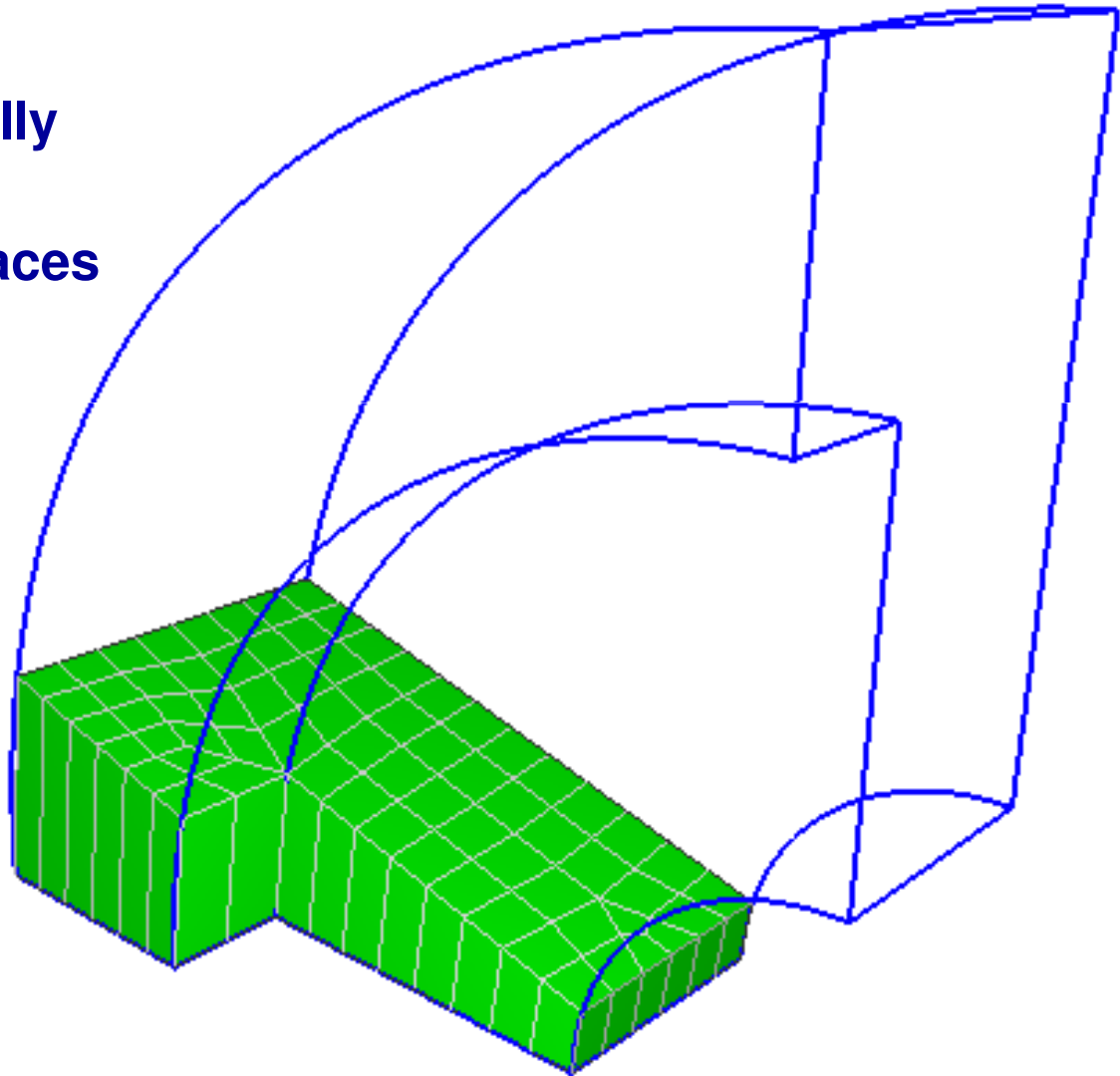

Structured mesh – Sweeping

- **Geometry Requirements**

- **Source and target surfaces topologically similar**
- **Mapped linked surfaces**

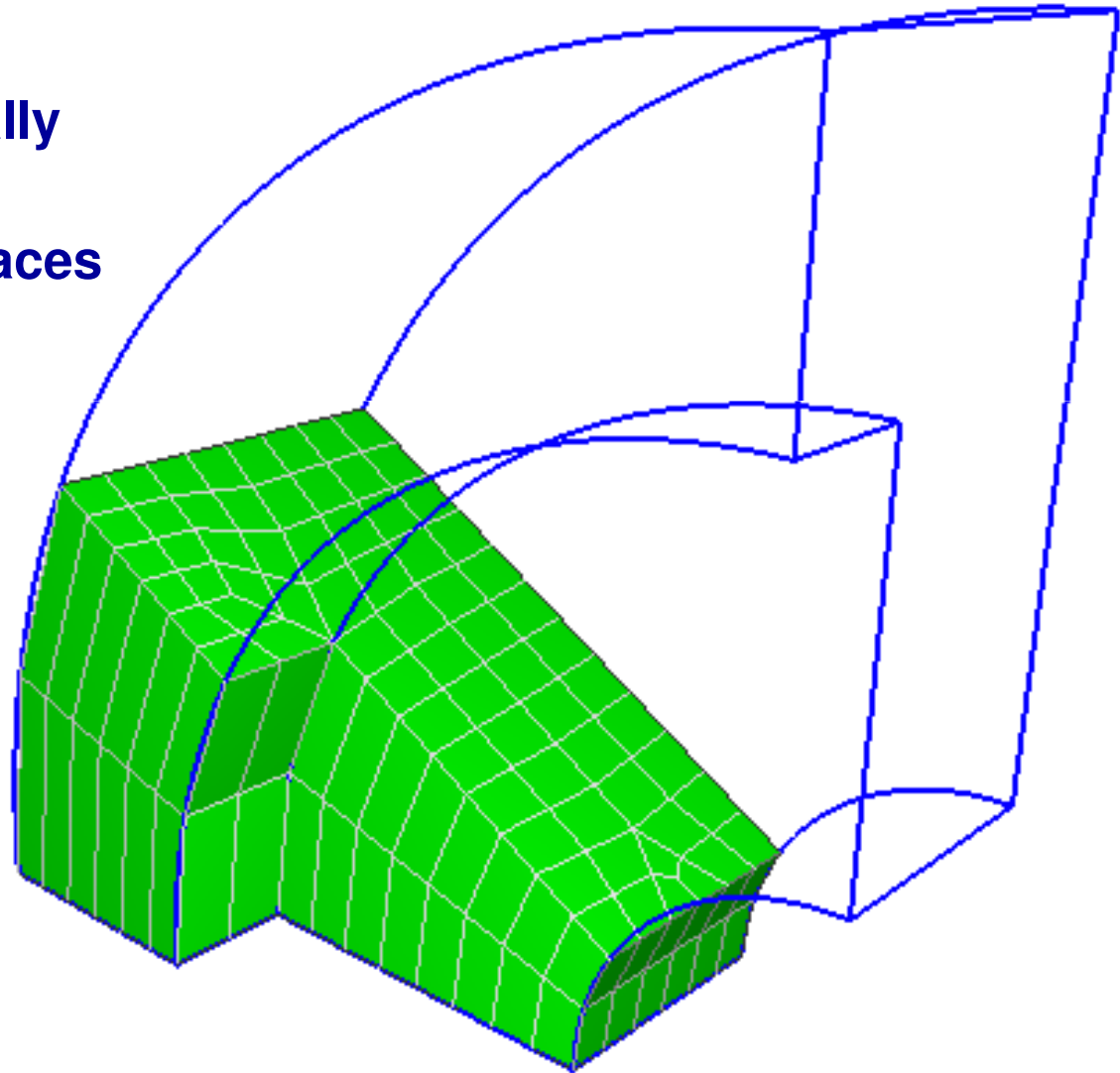

Structured mesh – Sweeping

- **Geometry Requirements**

- Source and target surfaces topologically similar
- Mapped linked surfaces

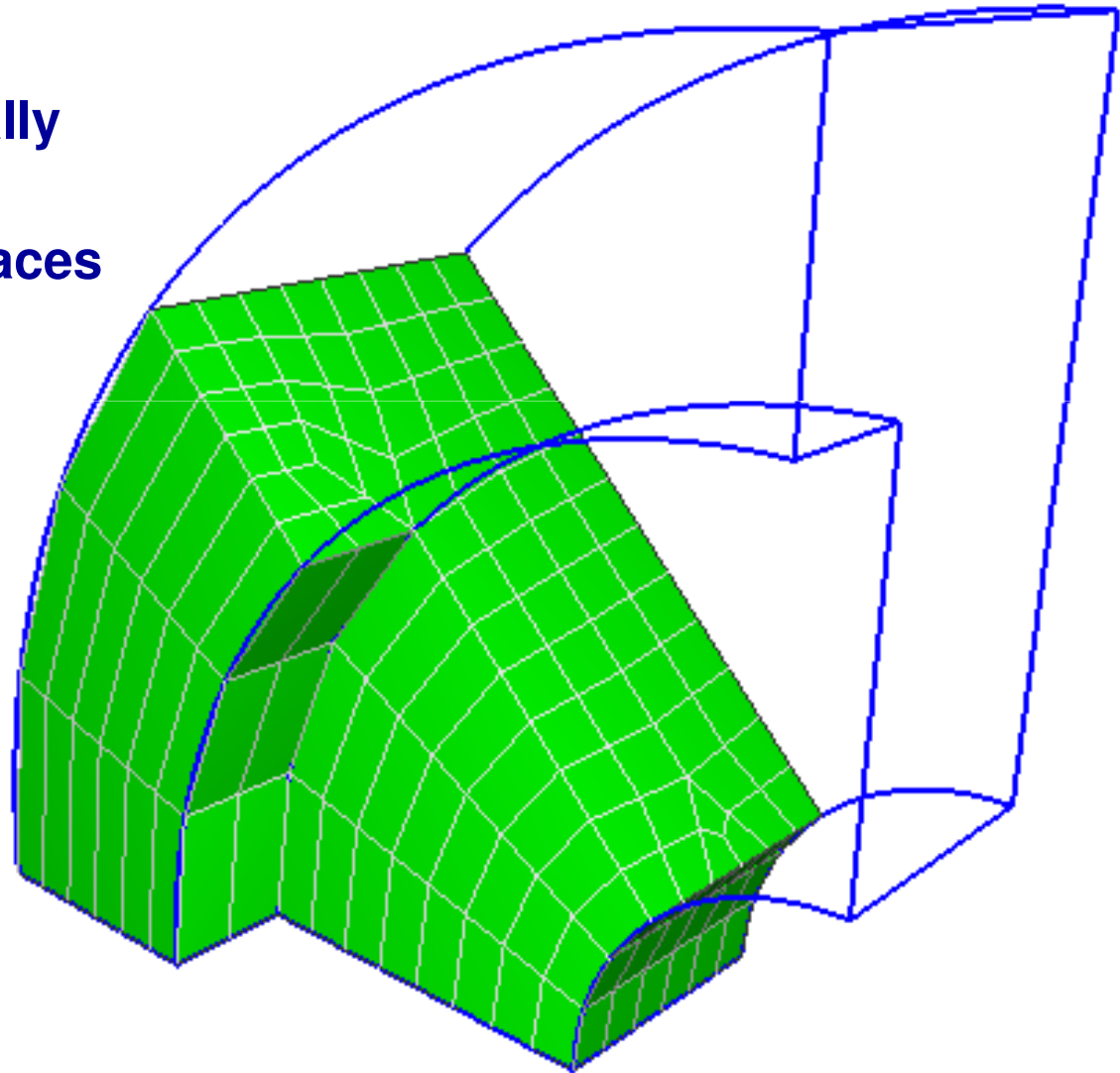

Structured mesh – Sweeping

- **Geometry Requirements**

- Source and target surfaces topologically similar
- Mapped linked surfaces

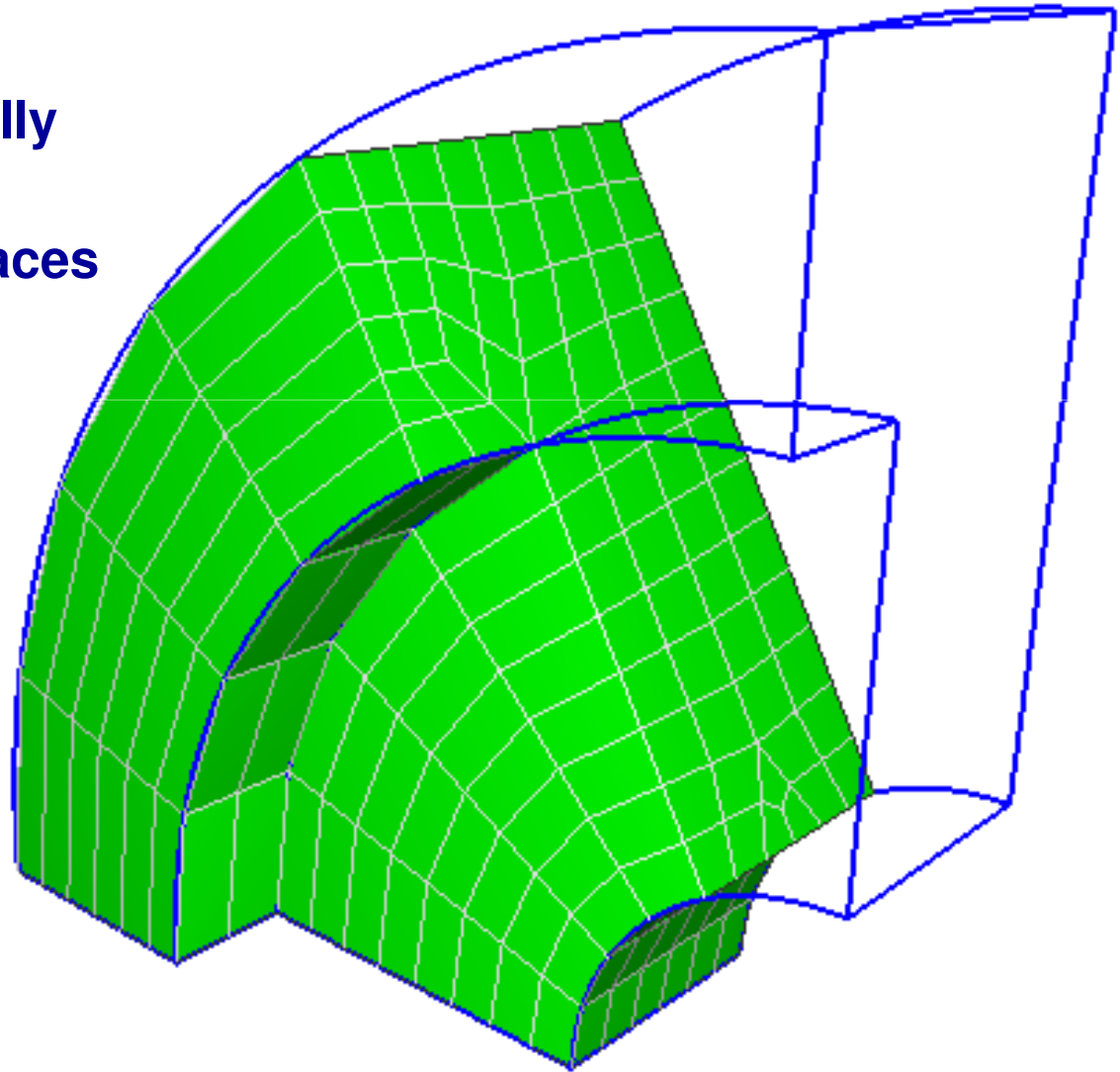

Structured mesh – Sweeping

- **Geometry Requirements**

- Source and target surfaces topologically similar
- Mapped linked surfaces

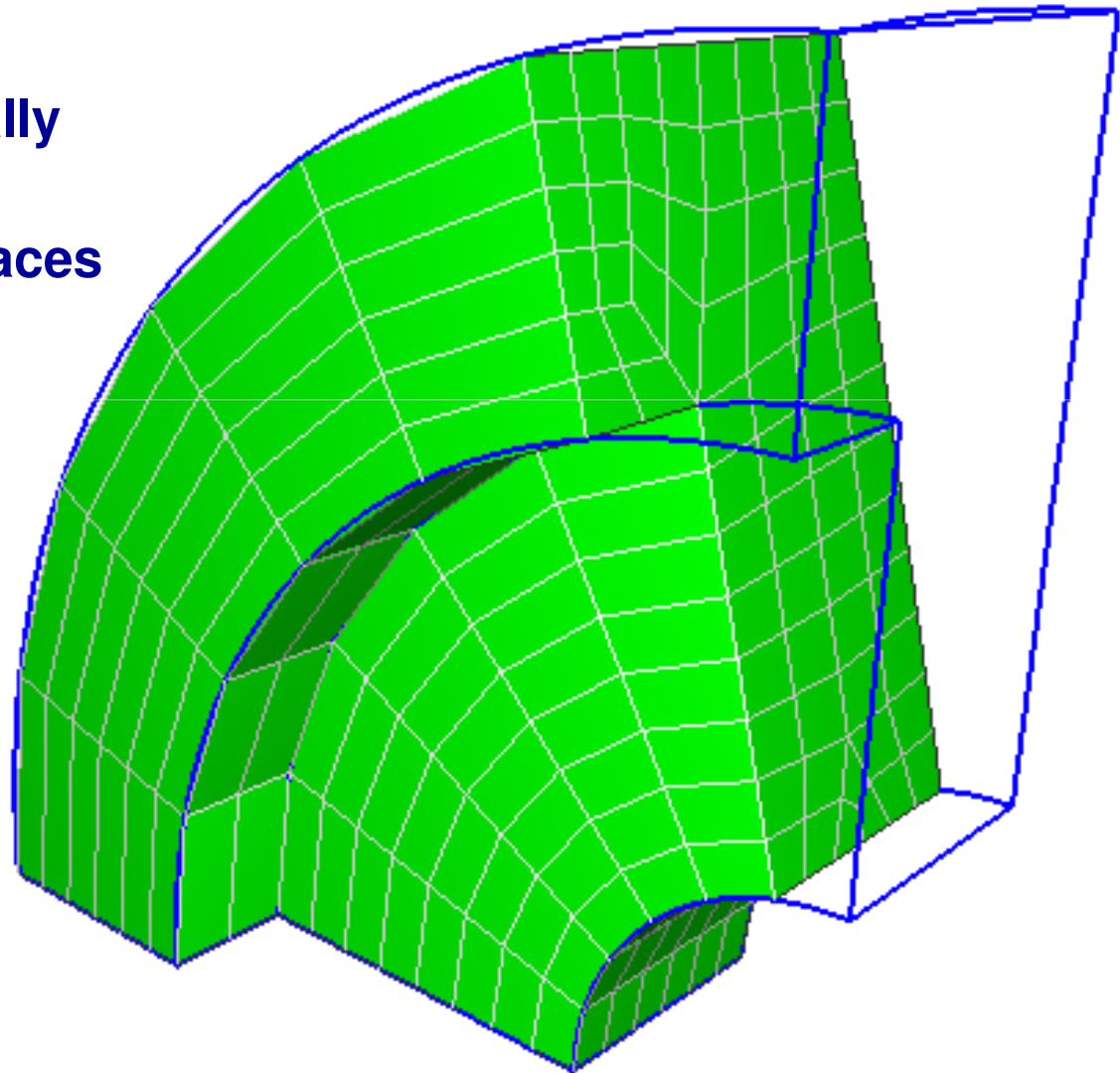



- **Geometry Requirements**
 - Source and target surfaces topologically similar
 - Mapped linked surfaces

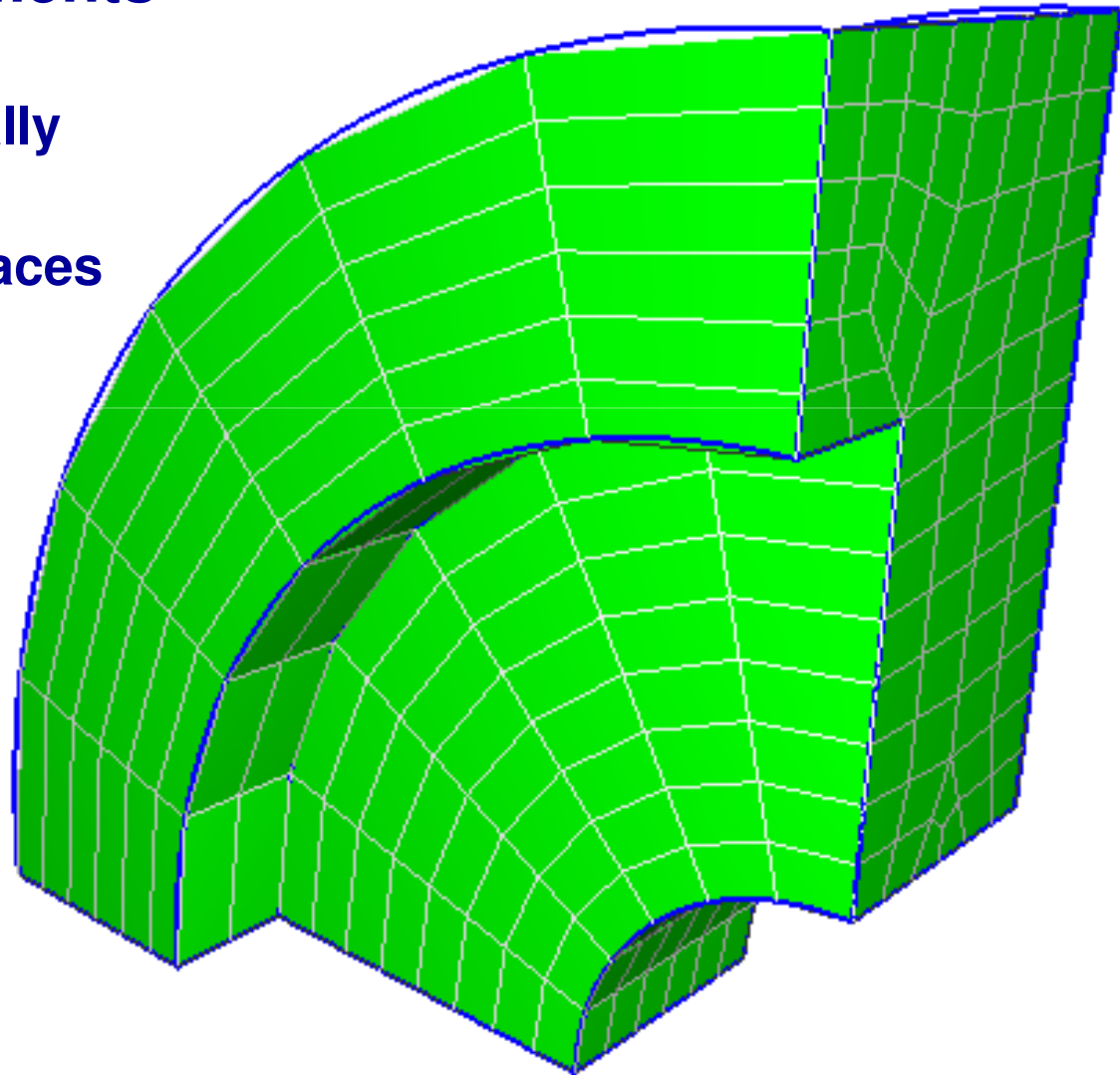

Structured mesh – Sweeping



- **Examples**

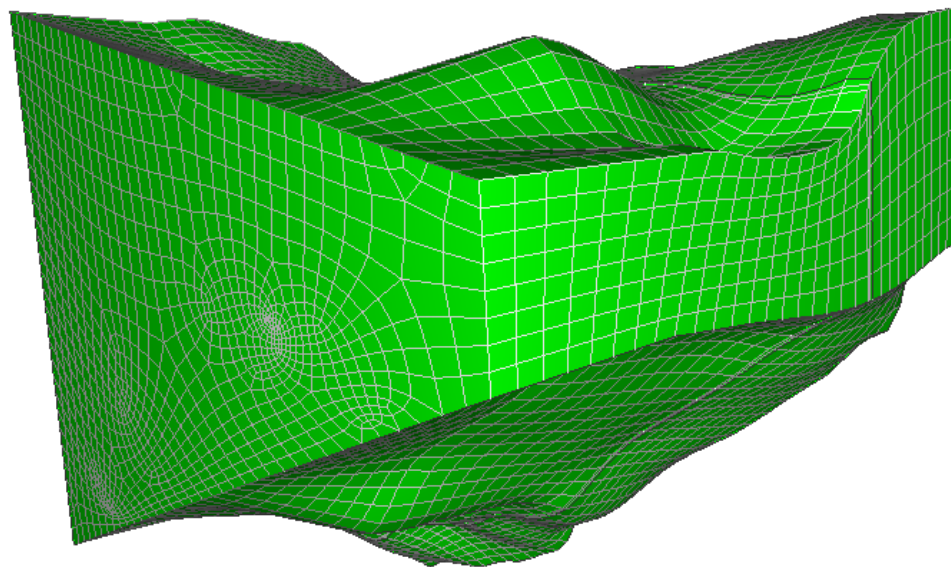
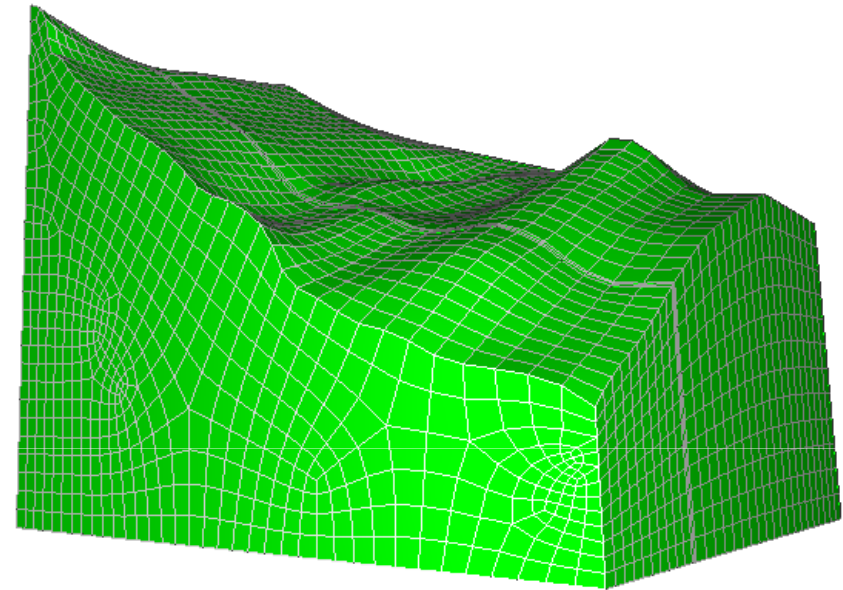
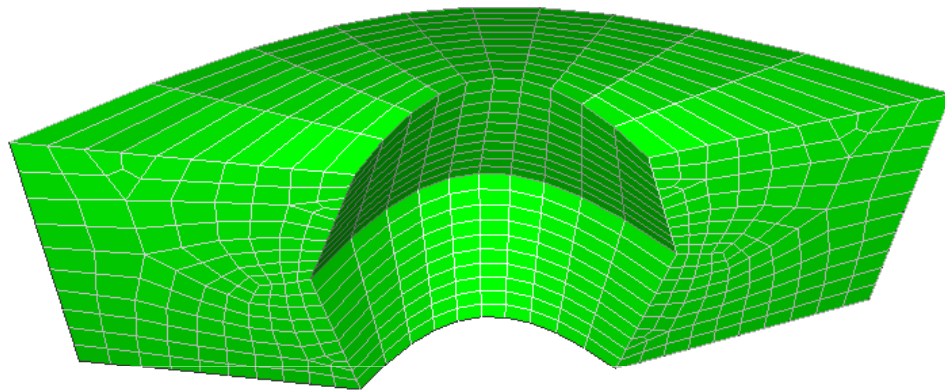

Structured mesh – Spline Sweeping



- **Geometry Requirements**
 - Sequence of sections
 - Meshes must be topologically equal

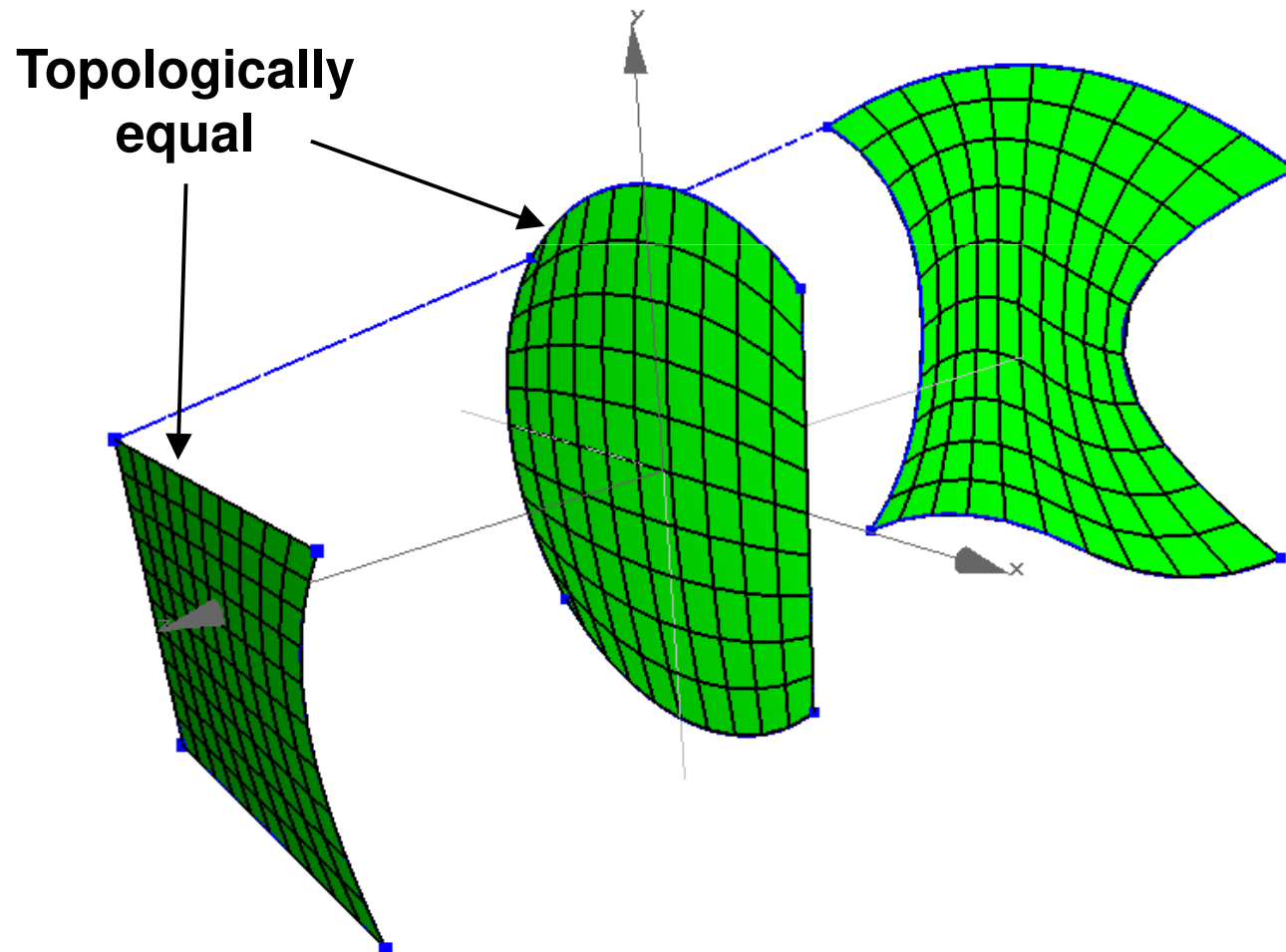

Structured mesh – Spline Sweeping



- **Geometry Requirements**
 - Sequence of sections
 - Meshes must be topologically equal

**Interpolated
by spline curves**

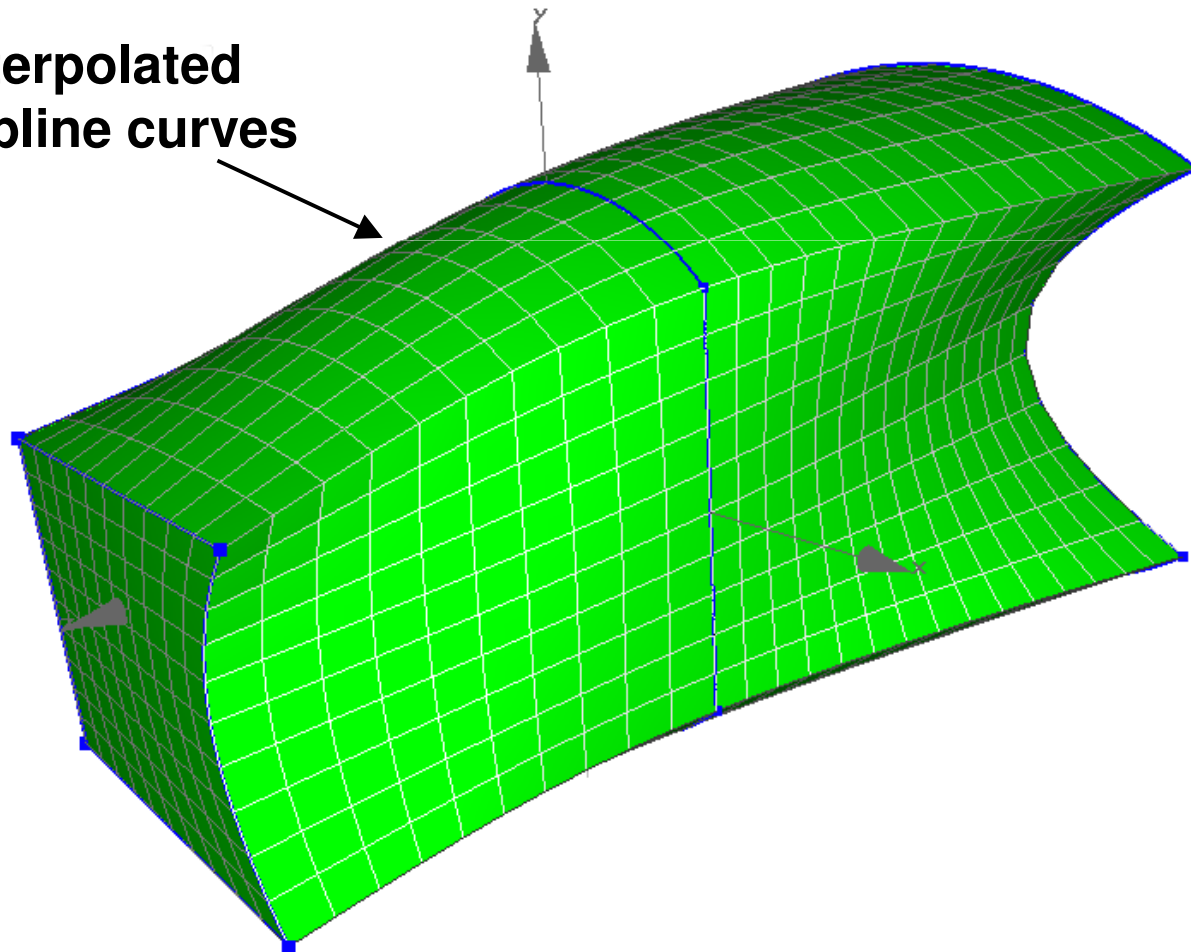

Structured mesh – Spline Sweeping

- **Geometry Requirements**
 - **Sequence of sections**
 - **Meshes must be topologically equal**

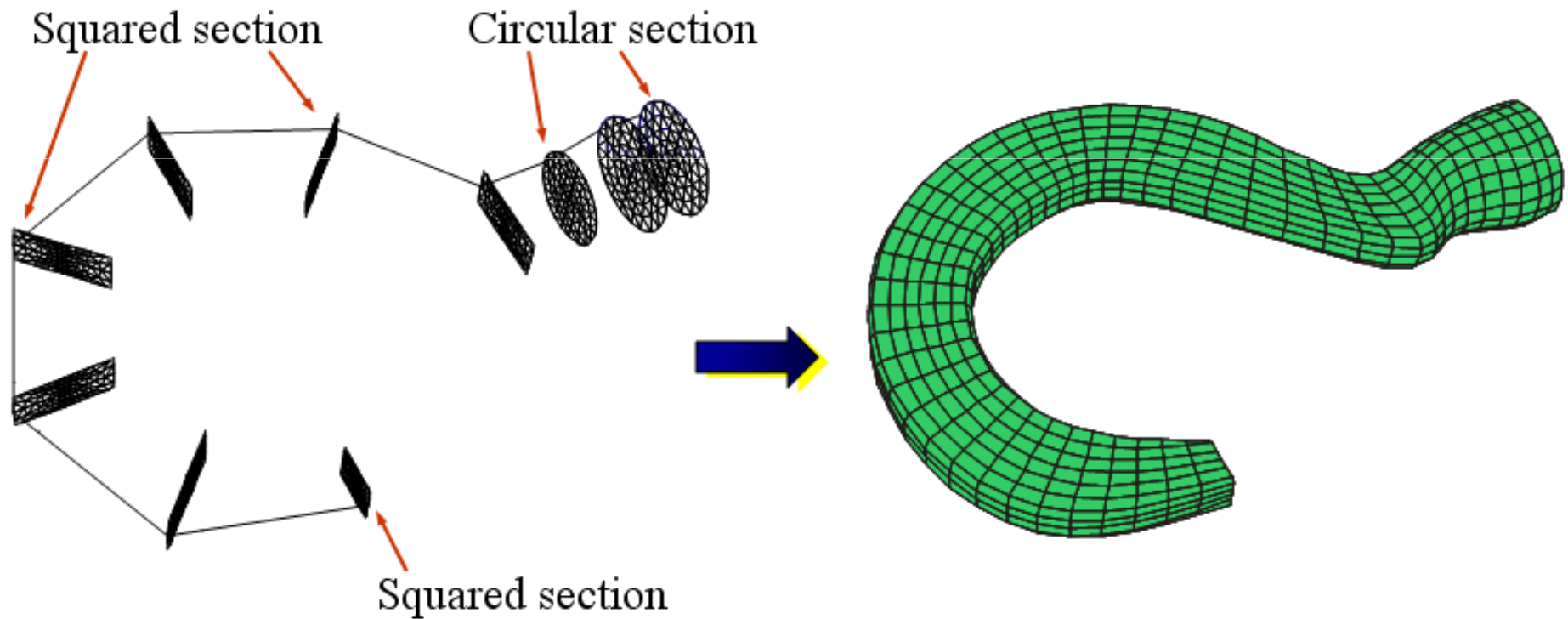

Structured mesh – Spline Sweeping

- **Geometry Requirements**
 - **Sequence of sections**
 - **Meshes must be topologically equal**

Squared sections

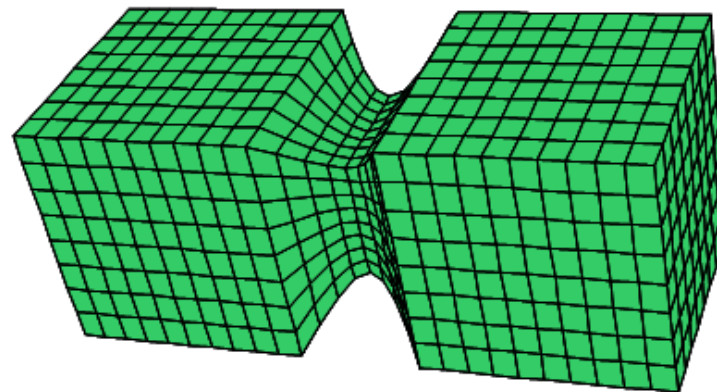
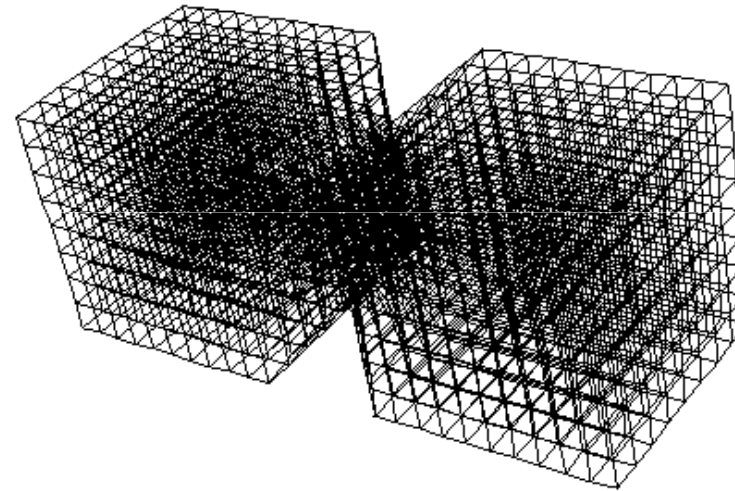
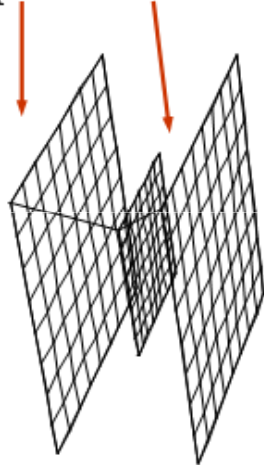

Unstructured mesh – Requirements



- **Specific algorithm requirements inherited from its ancestor**
 - **J-Mesh** (Joaquim Cavalcante-Neto, Wawrzynek, Carvalho, Martha & Ingraffea; 2001):
 - **Generation of well-shaped elements**
 - **Ability to conform to an existing refinement at the boundary of region**
 - **Ability to transition well between regions with different element sizes**
 - **Capability for modeling discontinuities (internal restriction and cracks)**
- **Additional requirements for surfaces**
 - **Locally refine the mesh in regions with curvatures**

Unstructured mesh generation outline



- **Background mesh generation – quadtree/octree**
 - Initialization based on boundary mesh.
 - Refinement to force a maximum cell size.
 - Refinement to provide minimum size disparity for adjacent cells.
- **Advancing-front procedure**
 - Geometry-based element generation
 - Topology-based element generation
 - Element generation based on back-tracking with face deletion.
- **Local mesh improvement**
 - Laplacian smoothing,
 - Local back-tracking with element deletion, or
 - Taubin smoothing (surfaces)

Unstructured mesh – auxiliary background structure

- **Quadtree and Octree**

- Fast search procedures to navigate through end leaves
- Represent the desired size of elements with nearly the same size as the end leaves

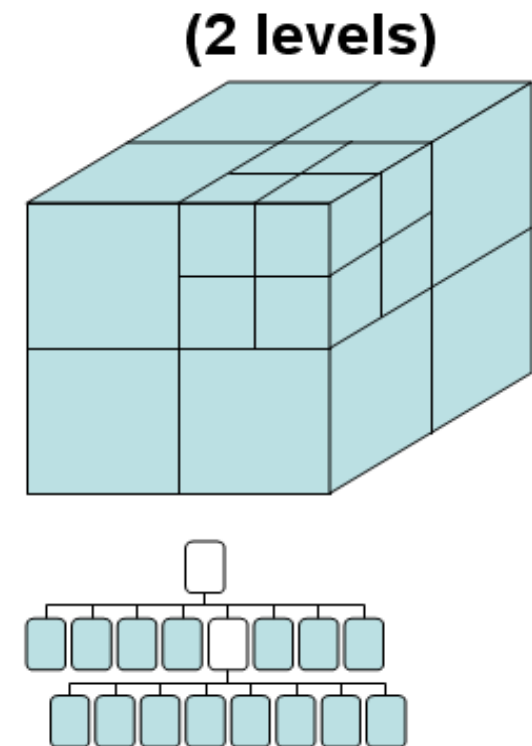
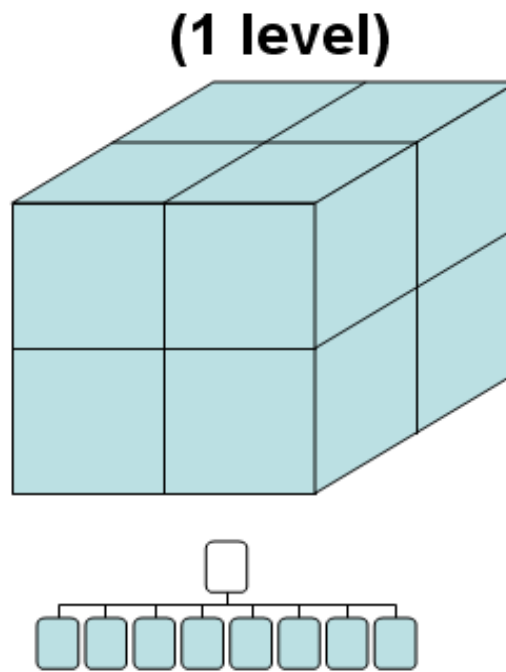
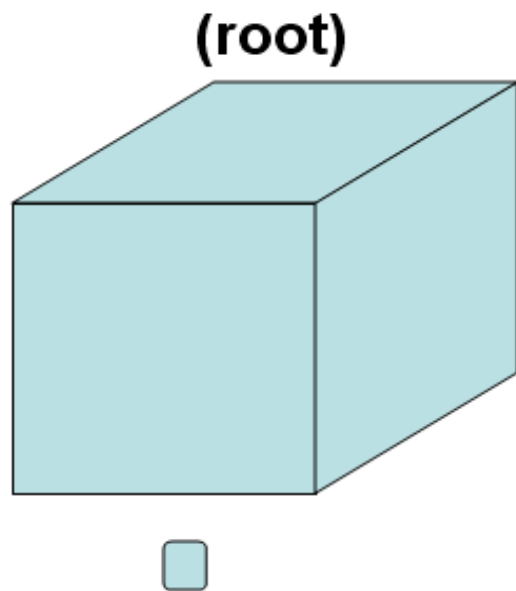

Unstructured mesh – 2D auxiliary background structure

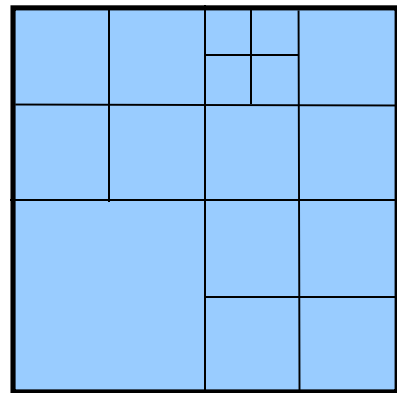

2D

- Create internal points on domain
- Advancing front algorithm

2D

- Create element using patterns in each cells
- Advancing front algorithm near boundary

2D

- Use cell size as guideline to generate new elements
- Advancing front algorithm

Surf

- Use cells to store desired sizes for elements and surface metric information
- Advancing front algorithm in parametric space

Unstructured mesh – 3D auxiliary background structure

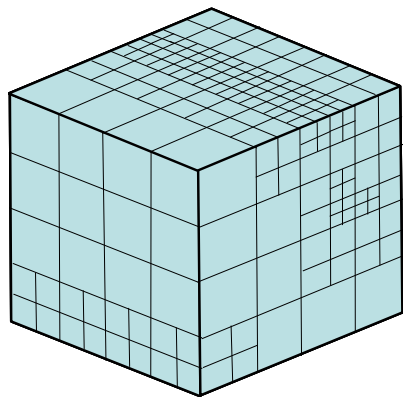

3D



- Use cells to store desired sizes for elements
- Advancing front algorithm

Surf



- Use cells to store desired sizes for elements and surface metric information
- Advancing front algorithm direct in 3D space

Unstructured mesh – background structure generation

- **Hypothetical 2D model and its boundary refinement**

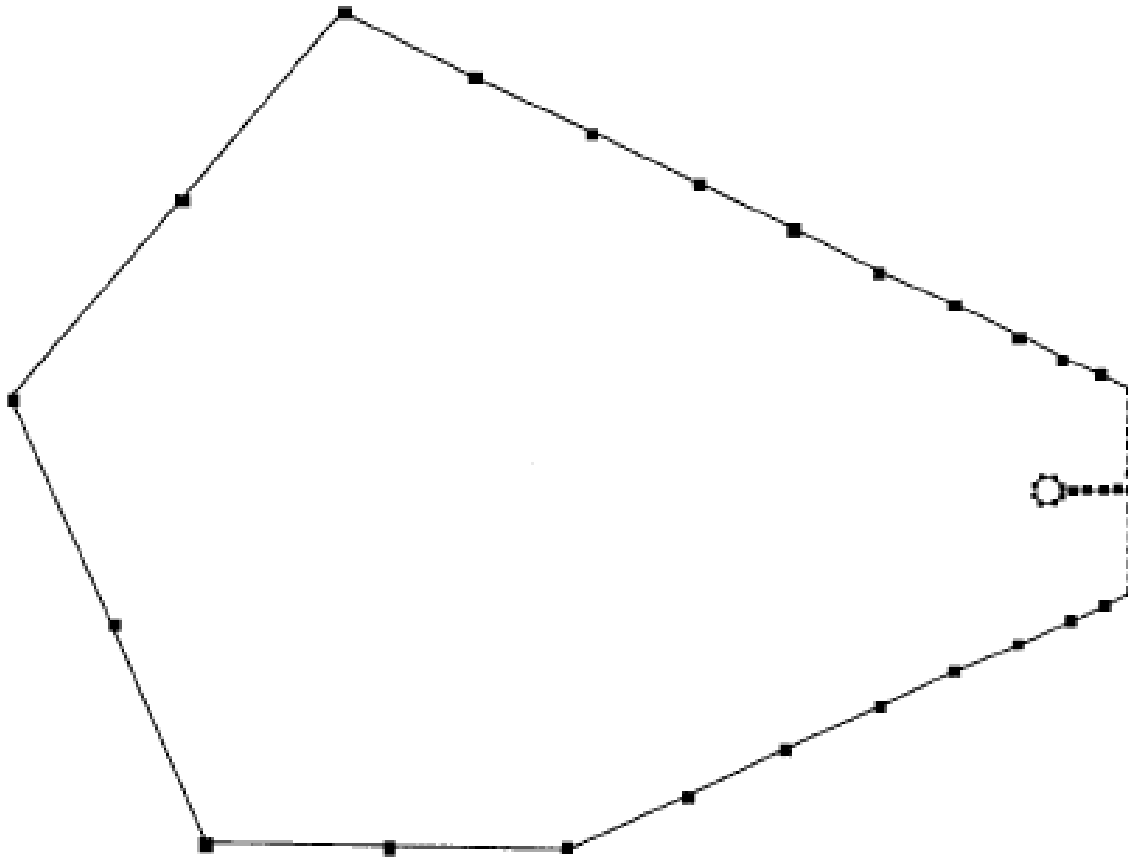

Unstructured mesh – background structure generation

- Initialization based on boundary mesh

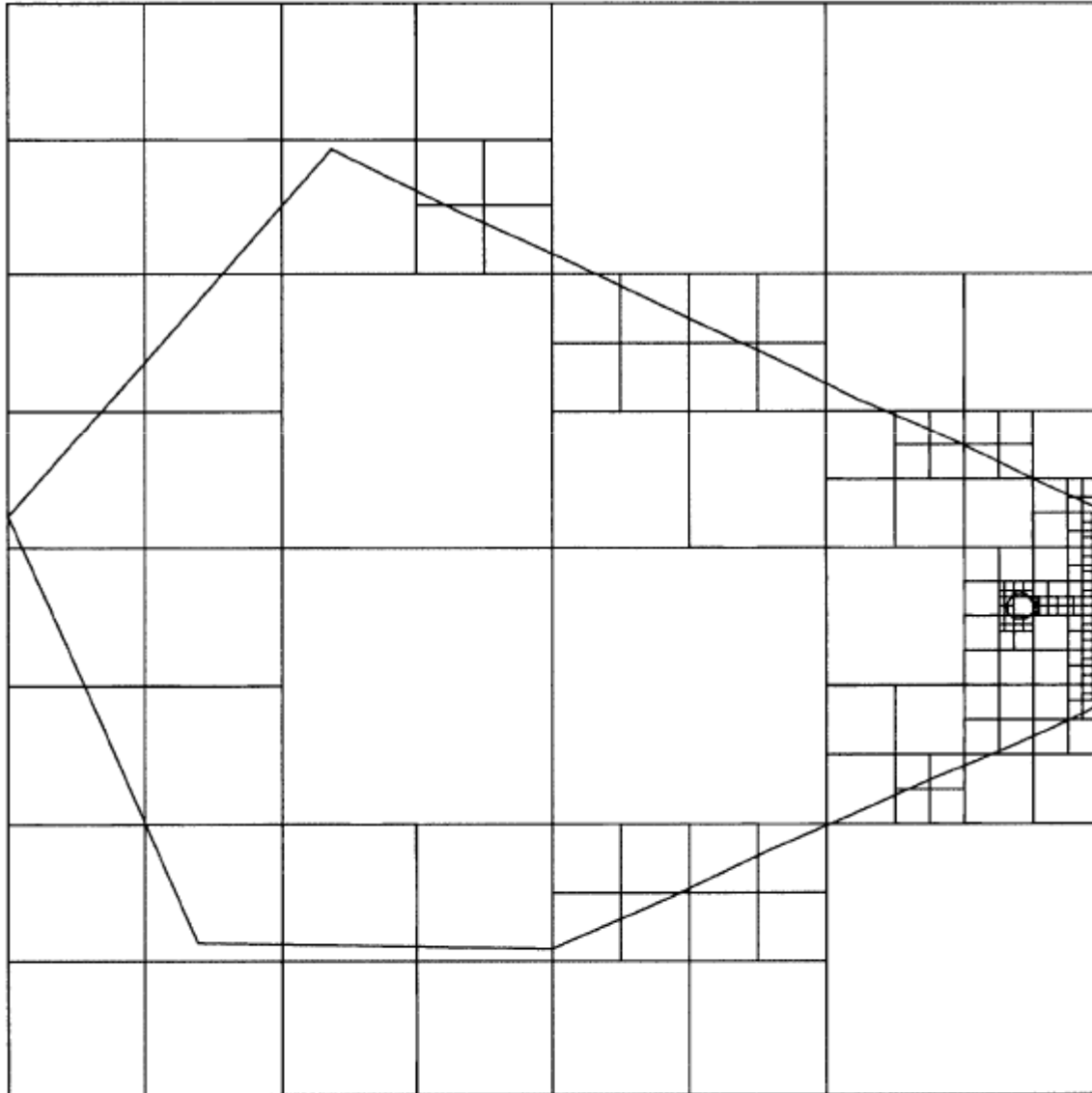

Unstructured mesh – background structure generation

- **Refinement to force a maximum cell size**

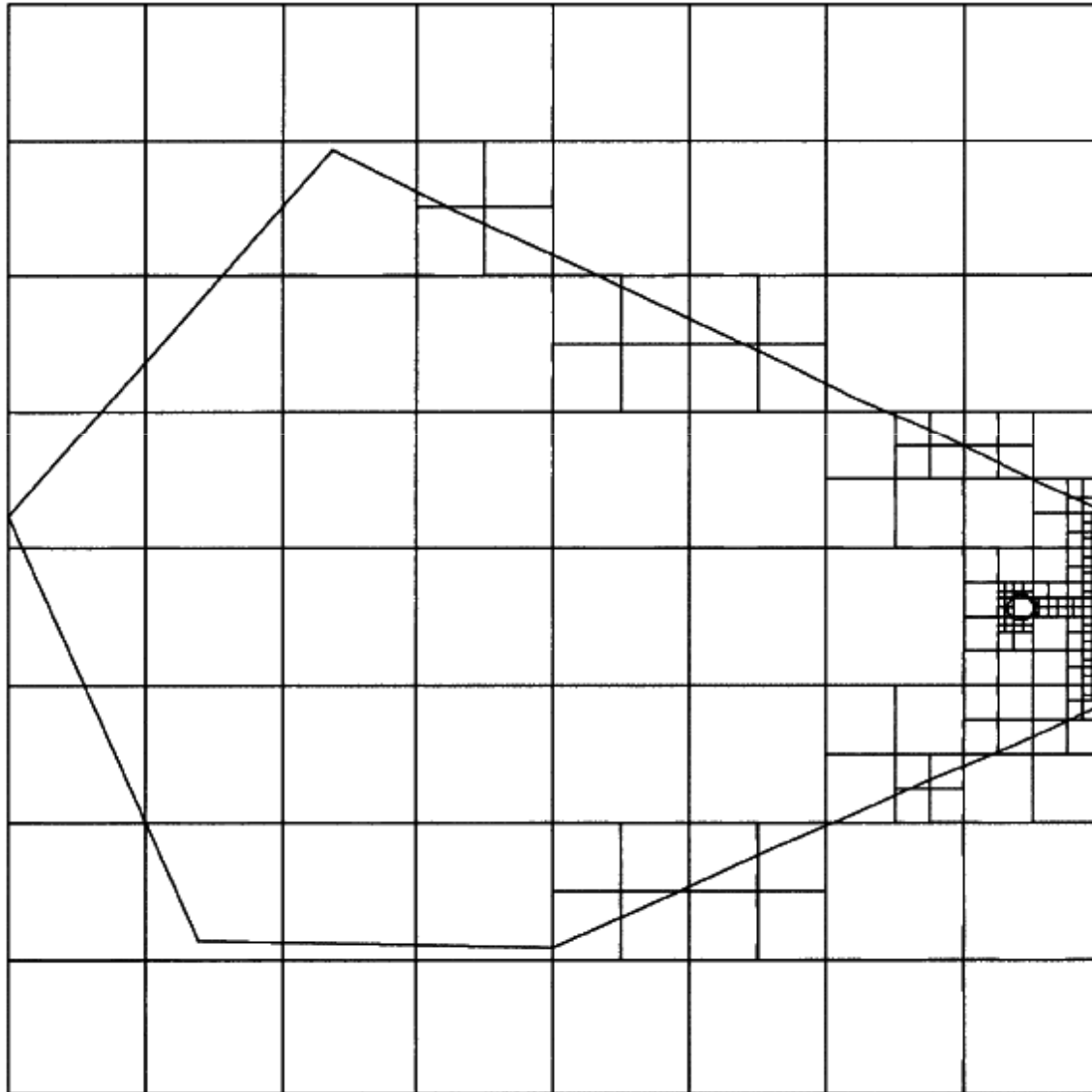

Unstructured mesh – background structure generation

- **Refinement to provide minimum size disparity for adjacent cells**

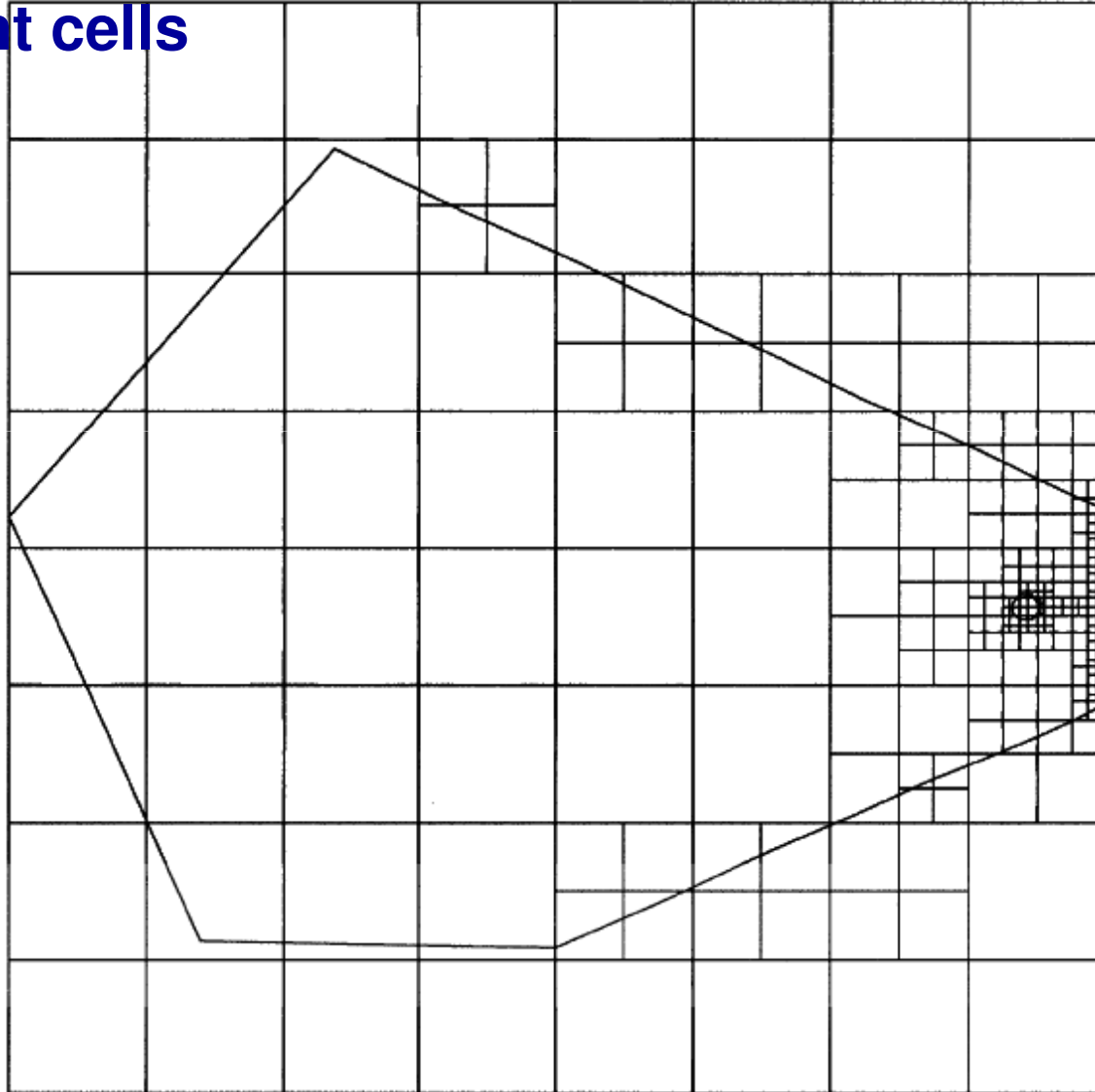

Unstructured mesh – background structure generation

- 3D model: octree refinement

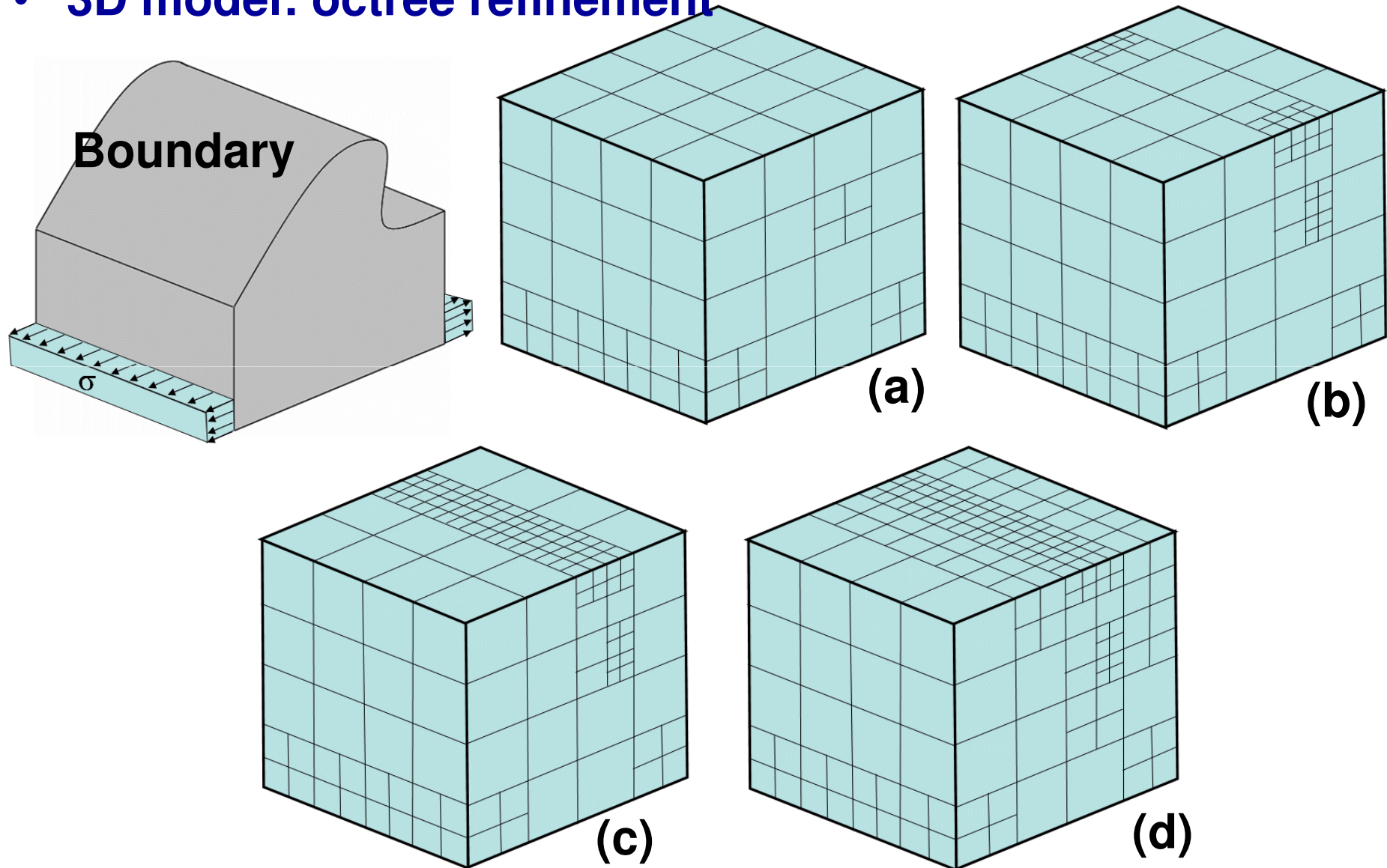

Unstructured mesh – advancing-front technique

- **Advancing front algorithm**

- **Begin with boundary mesh – define as initial *front***
- **For each edge (face) on front, locate initial node C based on front AB**

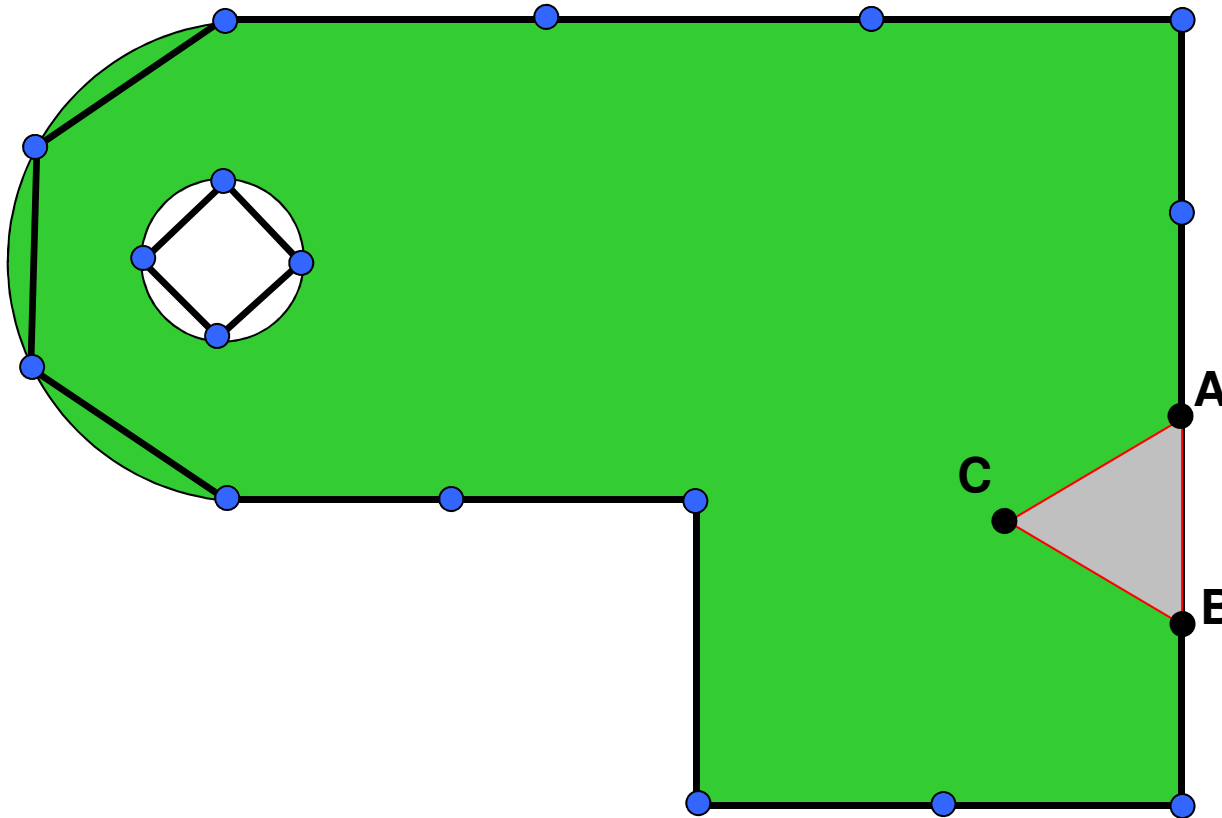

Unstructured mesh – advancing-front technique

- **Advancing front algorithm**
 - Determine if any other node on current front are within search radius r of ideal location C (Choose D instead of C)

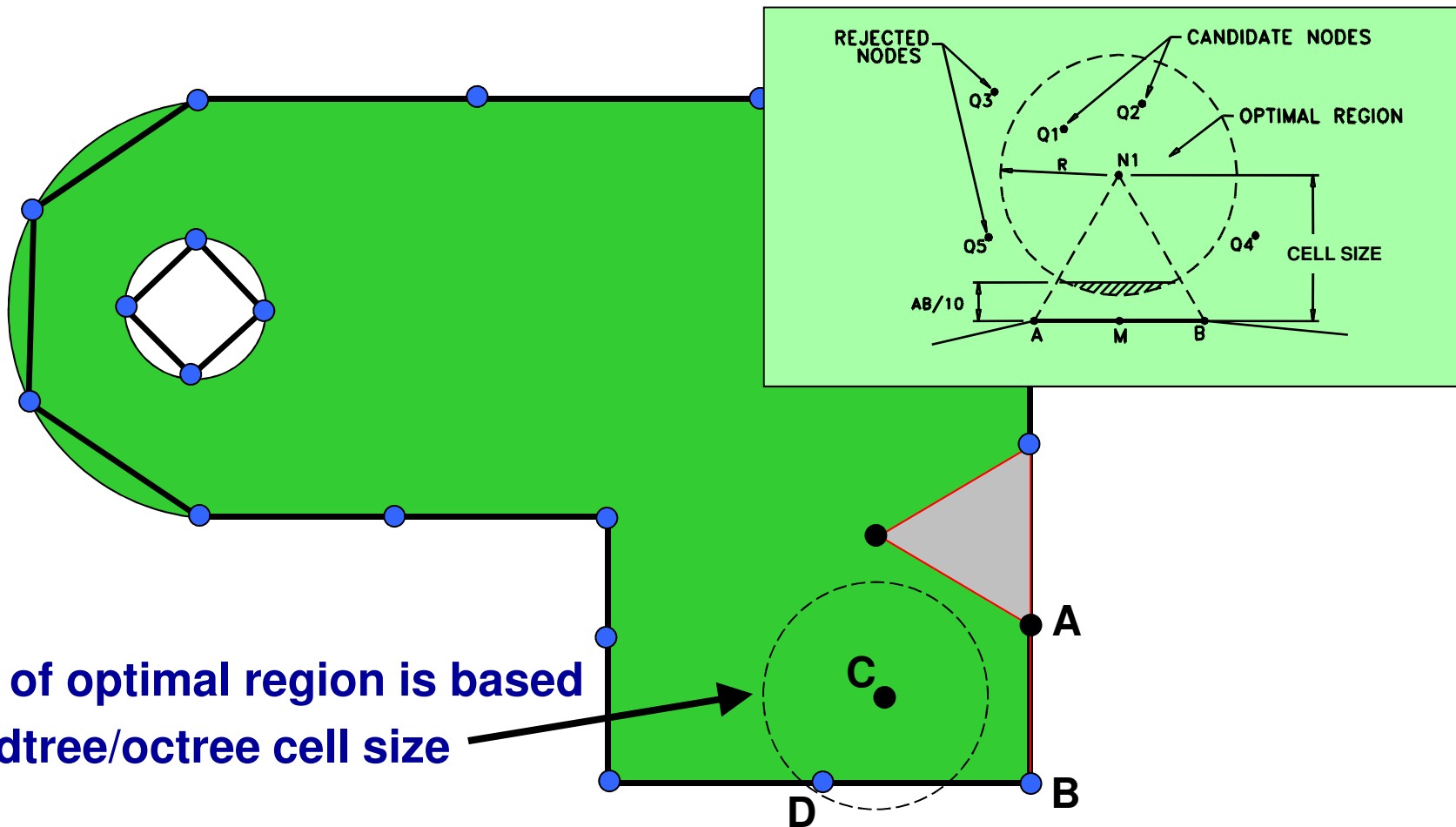

Unstructured mesh – advancing-front technique

- **Advancing front algorithm**
 - New *front edges (faces)* added and deleted from *front* as triangles (tetrahedral) are formed
 - Continue until *front edges (faces)* remain on *front*

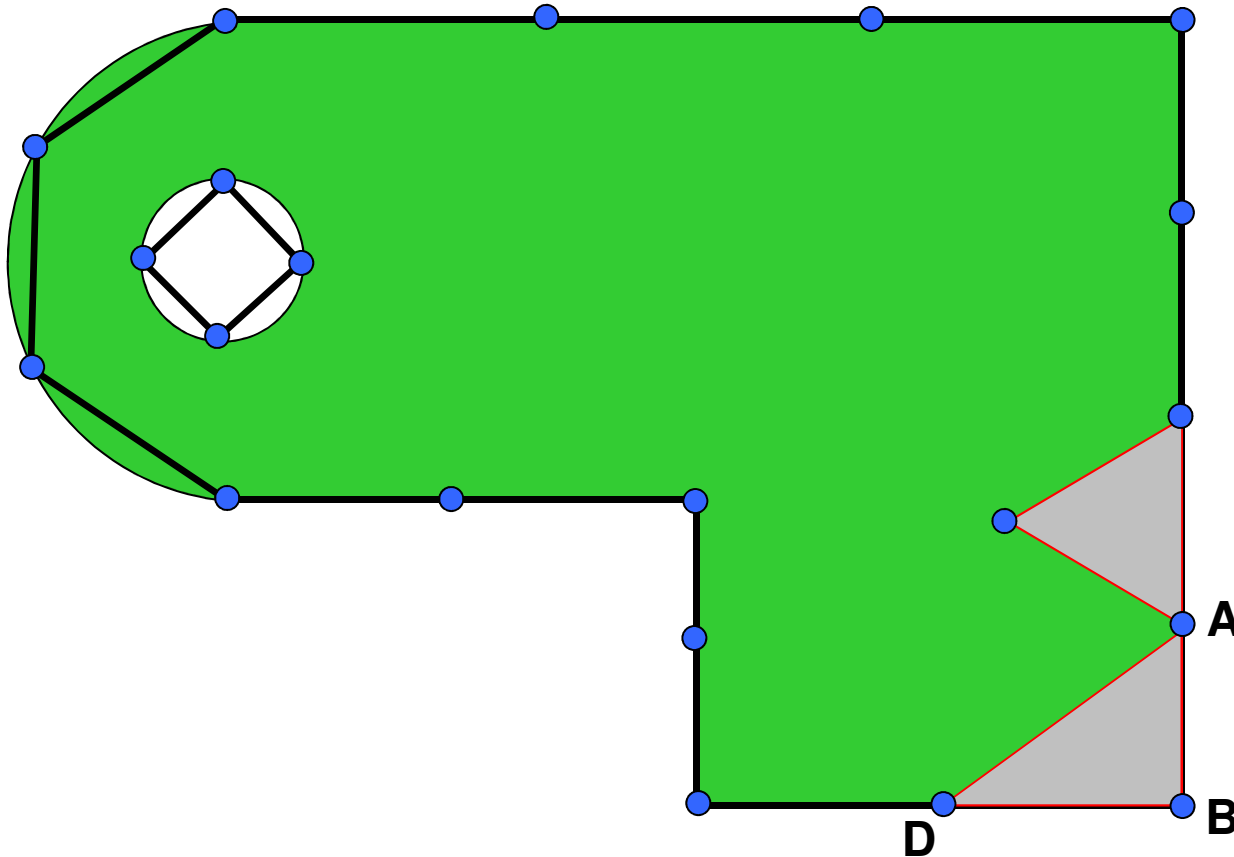

Unstructured mesh – advancing-front technique

- **Advancing front algorithm**
 - New *front edges* added and deleted from *front* as triangles are formed
 - Continue until *front edges* remain on *front*

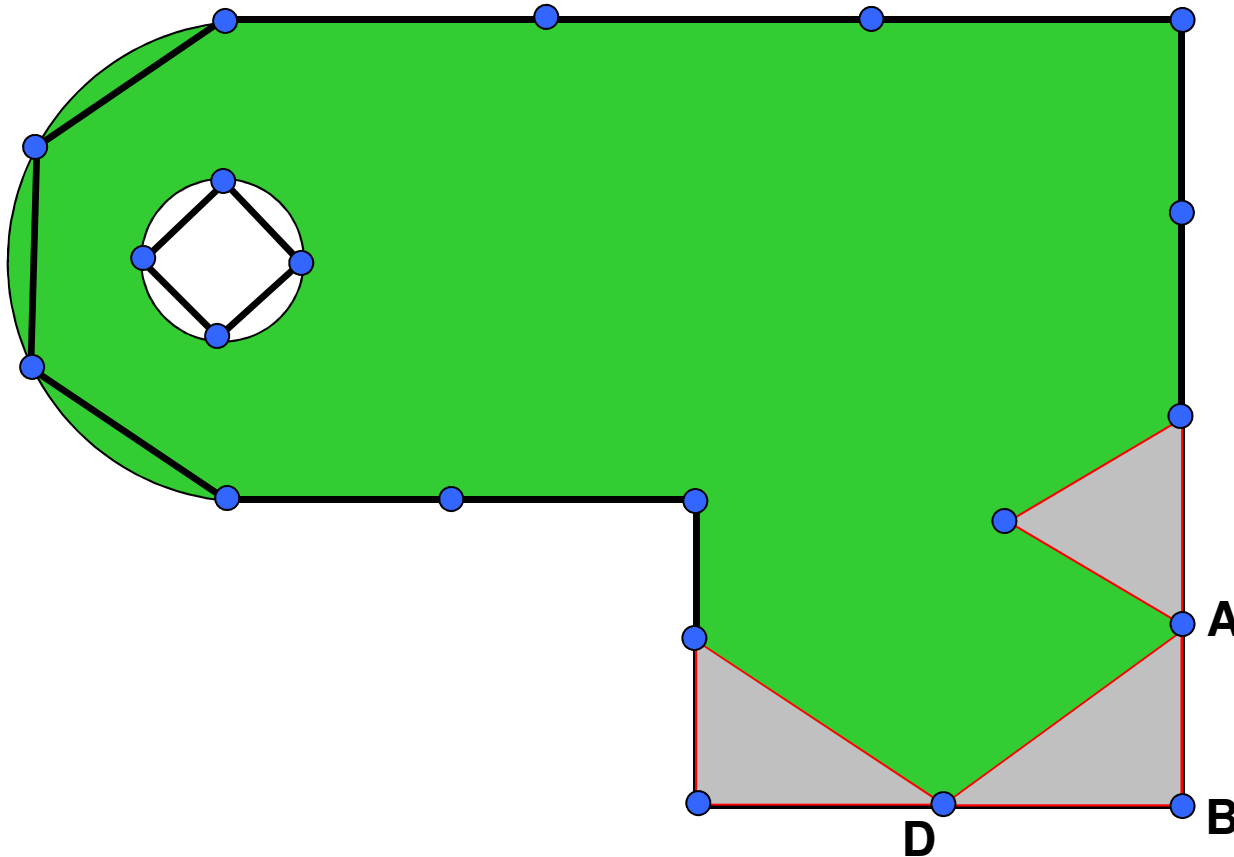

Unstructured mesh – advancing-front technique

- **Advancing front algorithm**
 - New *front edges* added and deleted from *front* as triangles are formed
 - Continue until *front edges* remain on *front*

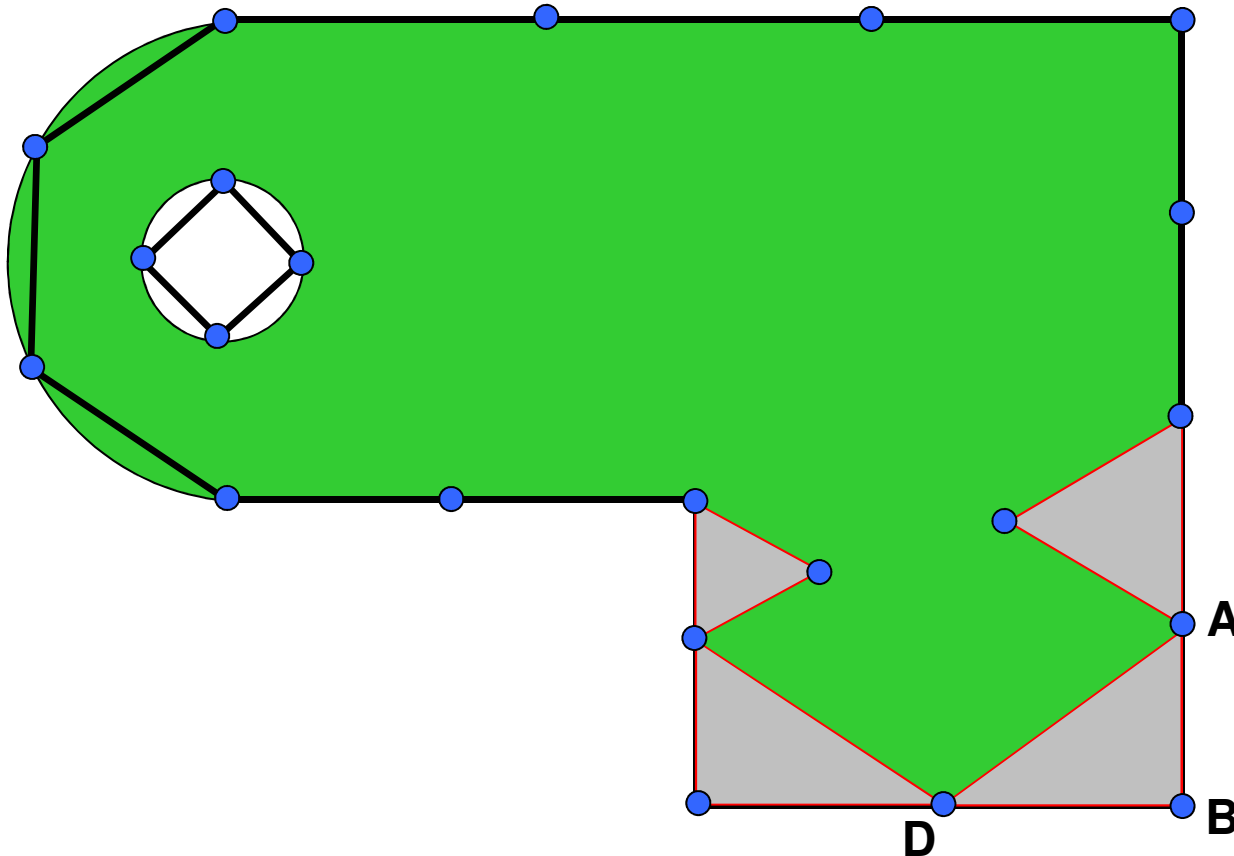

Unstructured mesh – advancing-front technique

- **Geometry-based element generation**

- **Boundary contraction list**
 - List of active edges
 - List of rejected edges
- **Generation of optimal elements**
 - Size of element
 - Optimal location N1
 - Ratio = $0.85 * \text{size}$
 - Upper bound and lower bound
 - Range Tree Search

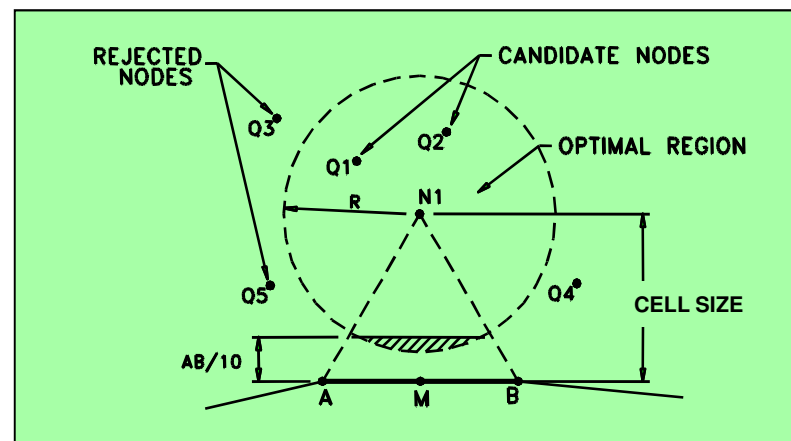
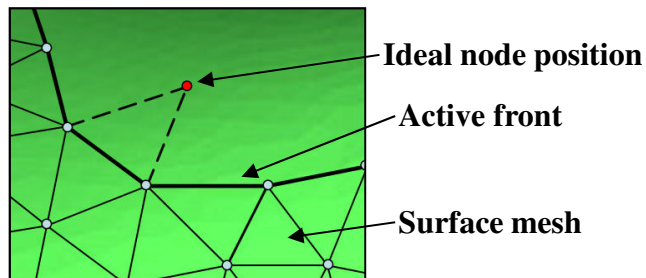
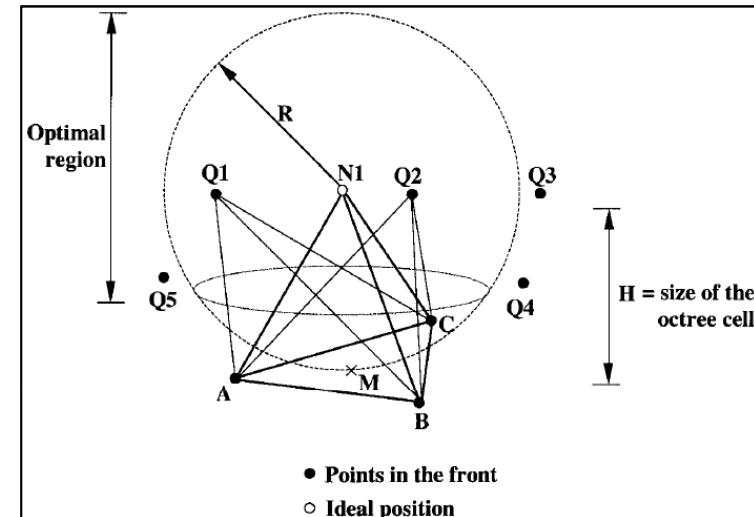

Unstructured mesh – advancing-front technique



- **Topology-based element generation**
 - List of rejected edges becomes active edges
 - Generation of elements by any node close to the base edge (best angle)
 - Generate a valid mesh, although not optimal

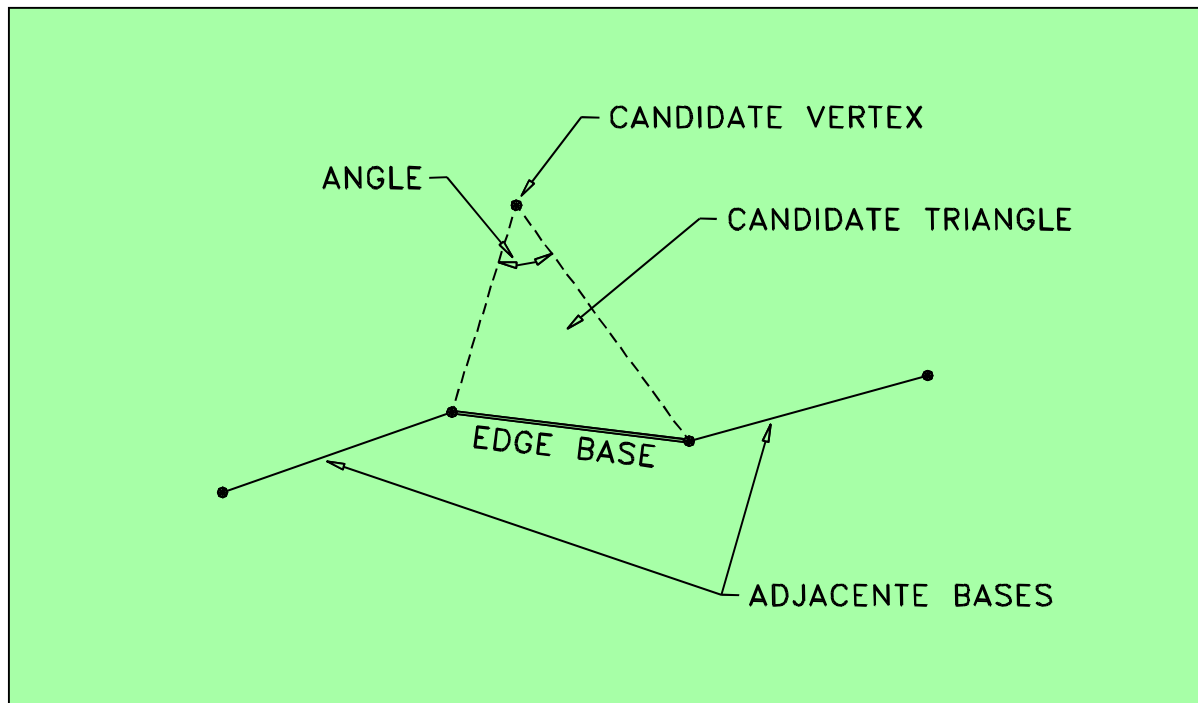

Unstructured mesh – advancing-front technique

- **Back-Tracking**

- **Locally modify the advancing front, deleting already generated adjacent tetrahedra until a ‘near’ convex non-meshed polyhedron is formed**

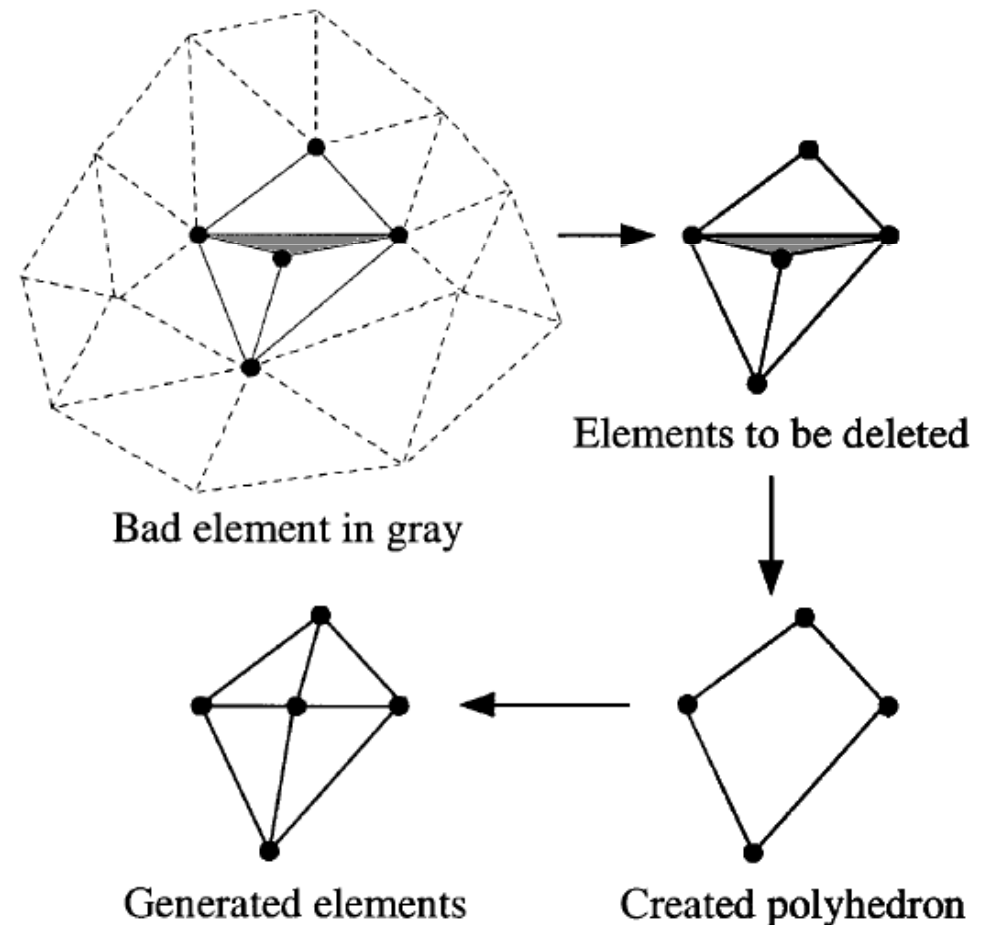
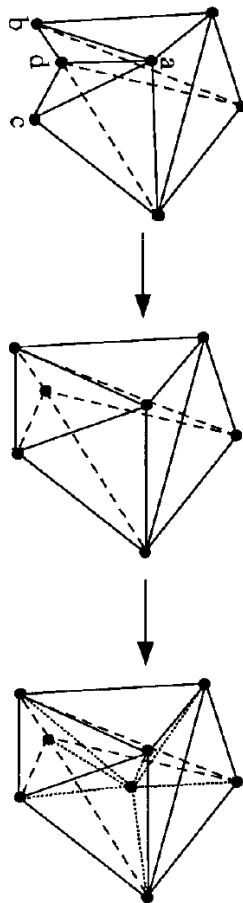

Unstructured mesh – local mesh improvement

- **Laplacian smoothing**

- Uses Laplacian equation and the closest point function for surface

$$X_0^{n+1} = X_0^n + \phi \frac{\sum_{i=1}^m w_{i0} (X_i^n - X_0^n)}{\sum_{i=1}^m w_{i0}}$$

- $\phi = 1.0$ and $w_{i0}=1.0$

- **Taubin smoothing (surfaces)**

- Uses twice Laplacian equation

- $\phi = 1.0$ and $w_{i0} = 0.63$
- $\phi = 1.0$ and $w_{i0} = -0.67$

- Filters high frequencies

- Preserves the low frequencies

- Good results with geological and microstructure surfaces

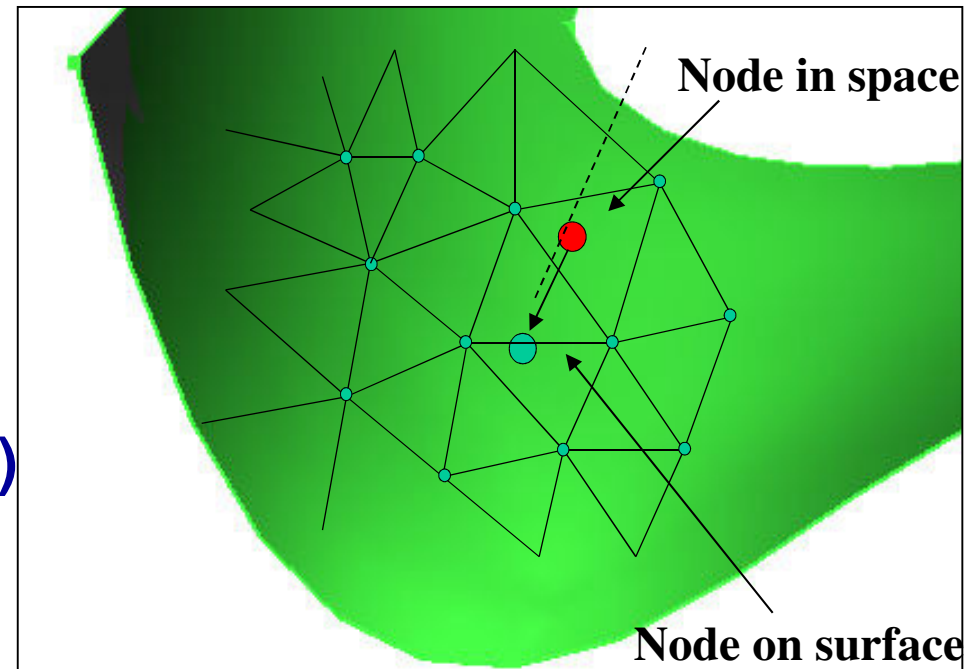

Unstructured mesh – Surface Meshing

- **Direct 3D Meshing**

- Elements formed in 3D using actual x-y-z representation of surface

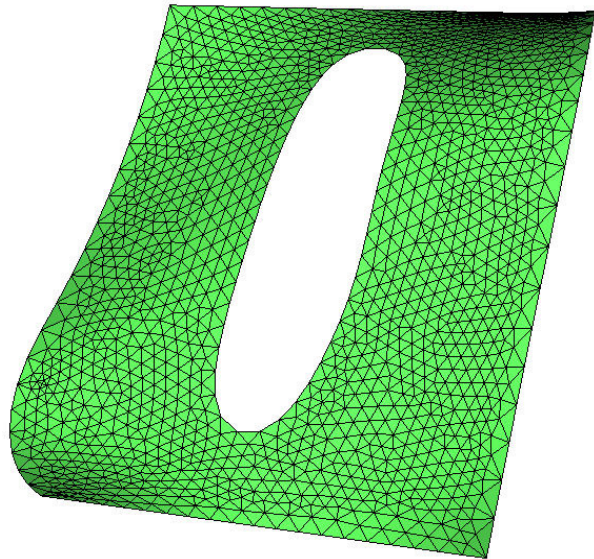

- **Parametric Space Meshing**

- Elements formed in 2D using parametric representation of surface
- Nodes locations later mapped to 3D space

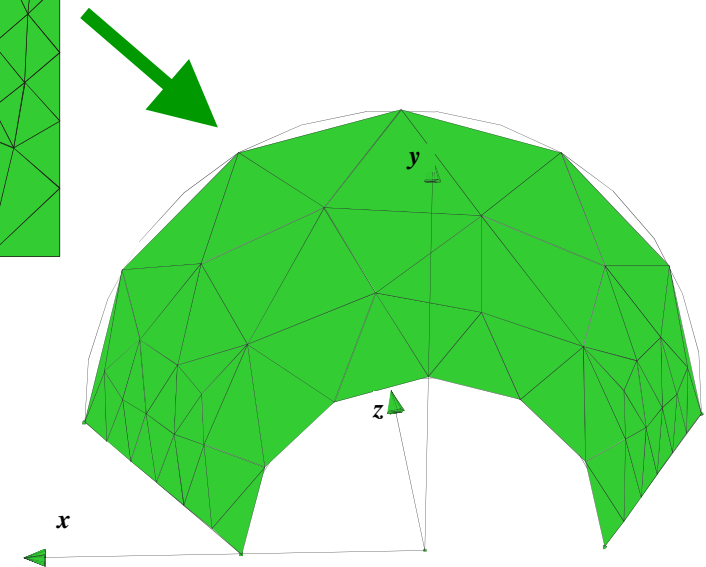
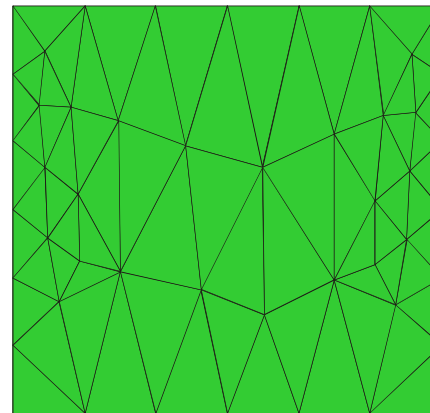

Unstructured mesh – Surface Meshing

- **Direct 3D Meshing**

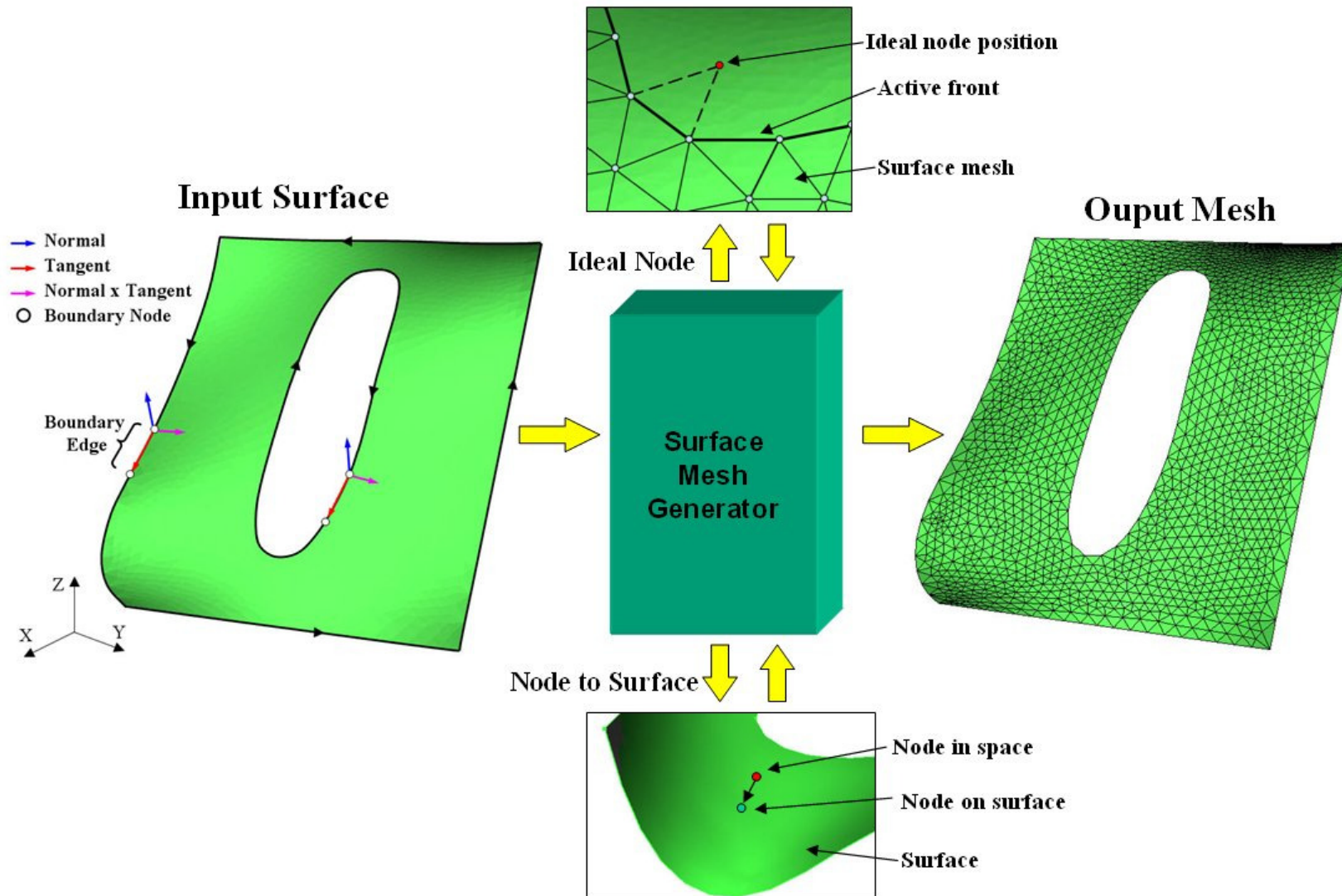

Unstructured mesh – Surface Meshing

- **Direct 3D Meshing – refinement of octree**

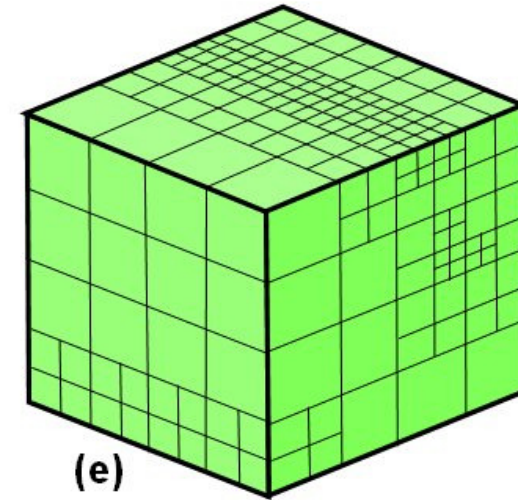
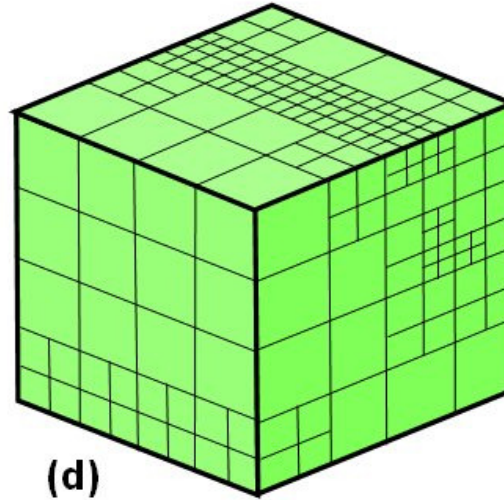
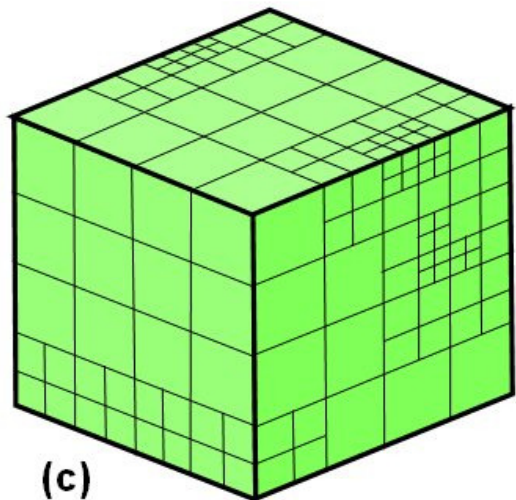
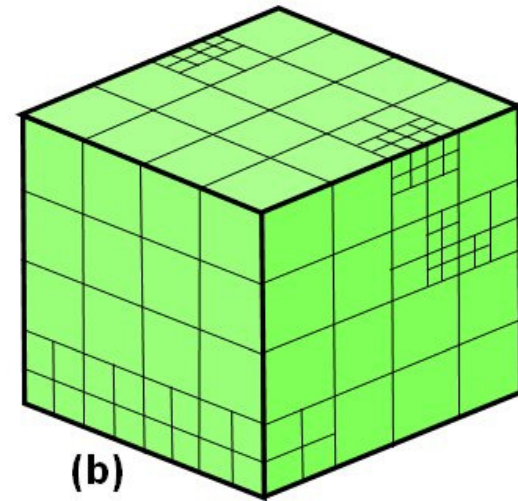
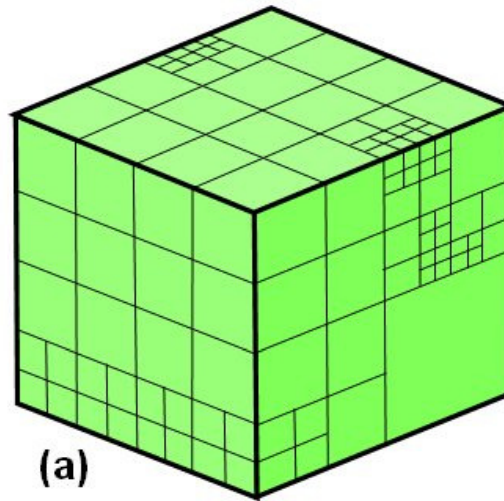
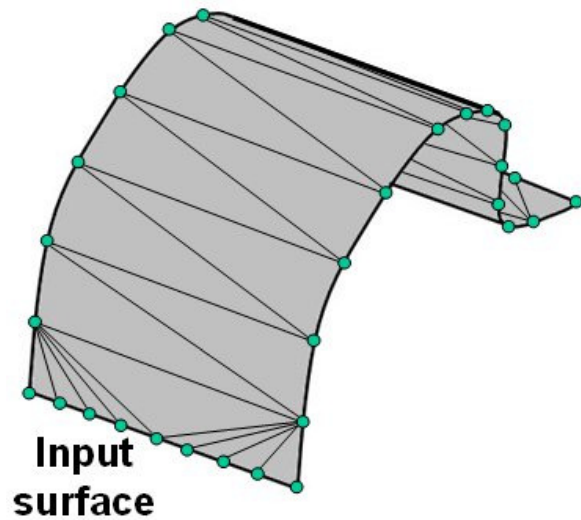

Unstructured mesh – Surface Meshing

- **Direct 3D Meshing – node location**

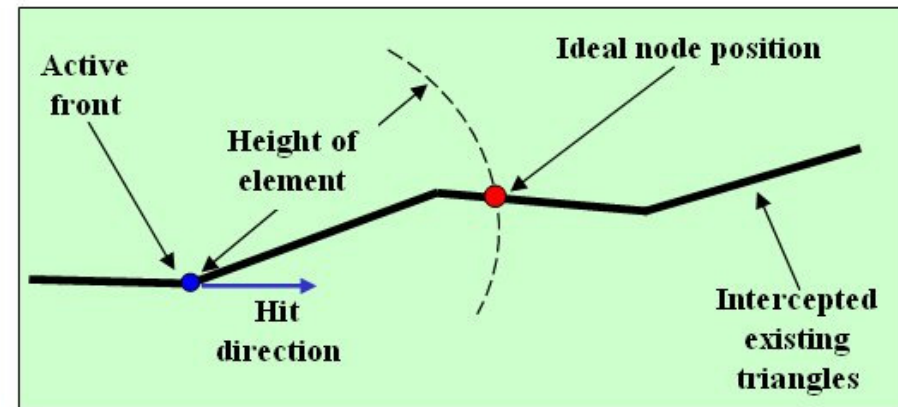
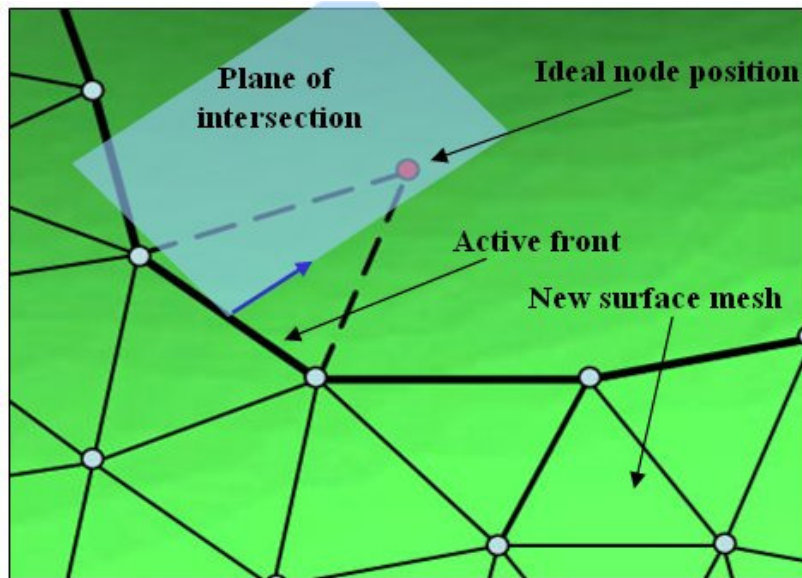

Unstructured mesh – Surface Meshing



- **Direct 3D Meshing – Examples**

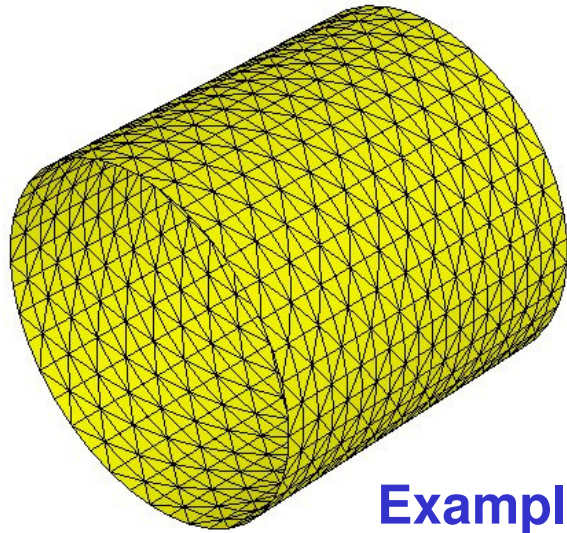

Example 1

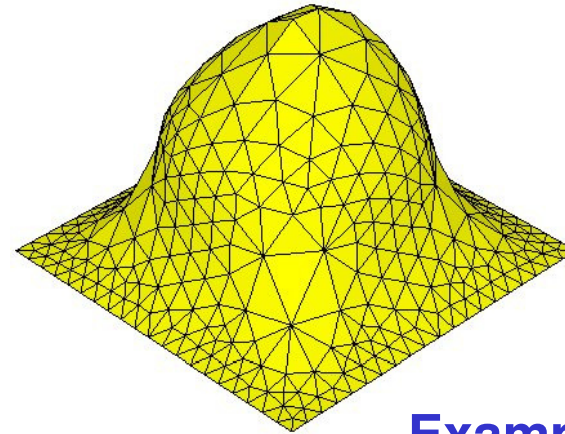

Example 2

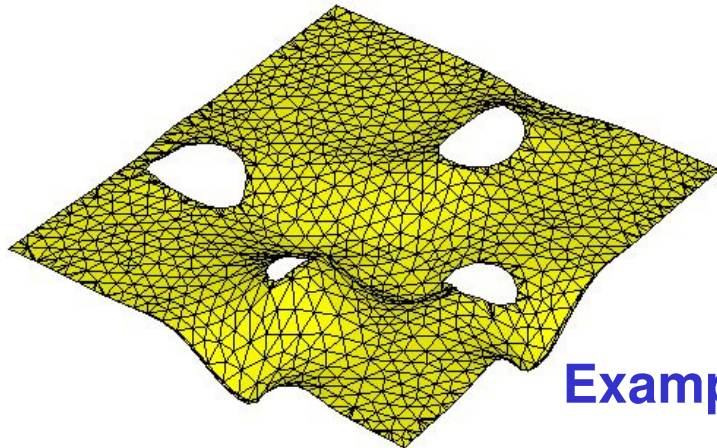

Example 3

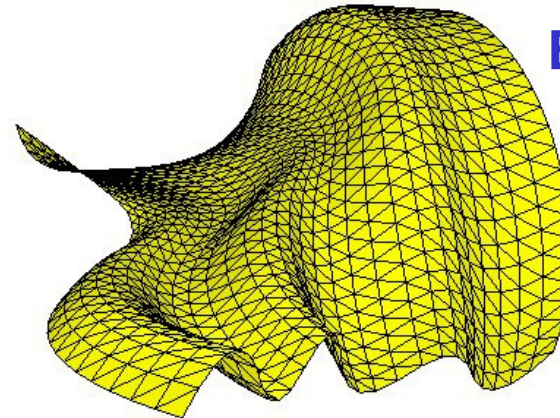

Example 4

Unstructured mesh – Surface Meshing



- **Direct 3D Meshing – Examples**

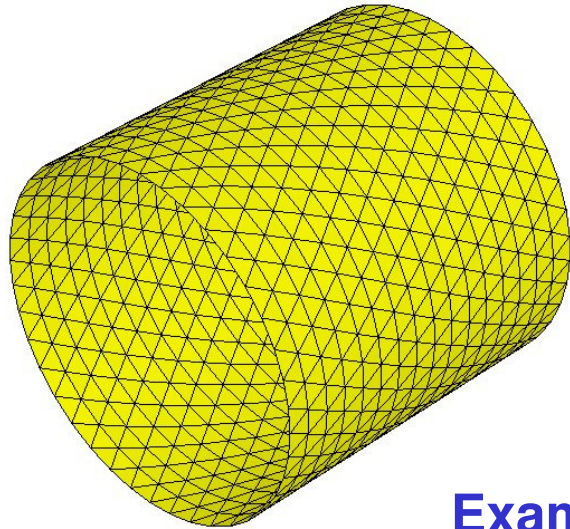

Example 1

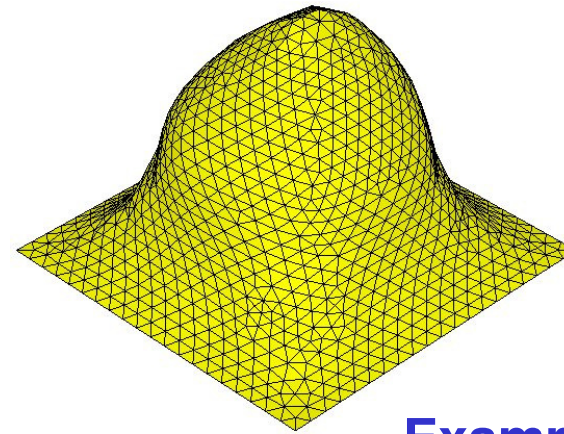

Example 2

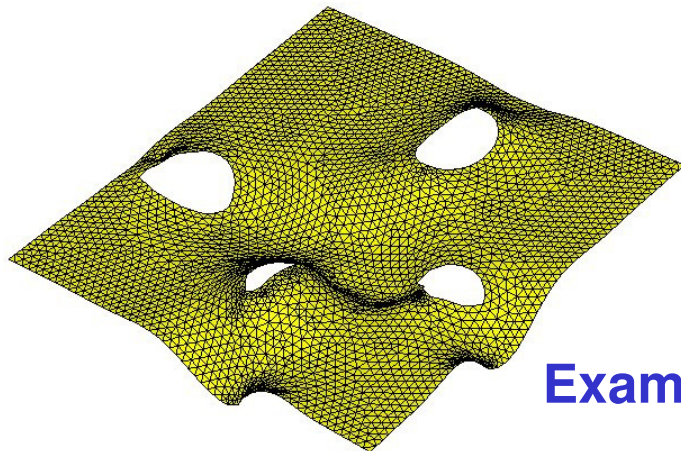

Example 3

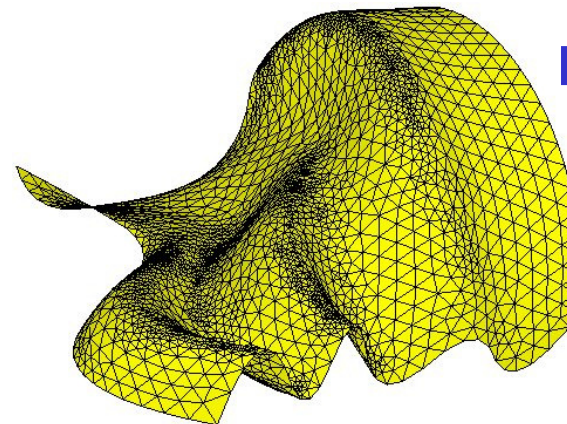

Example 4

Imported triangulation with poorly-shaped elements

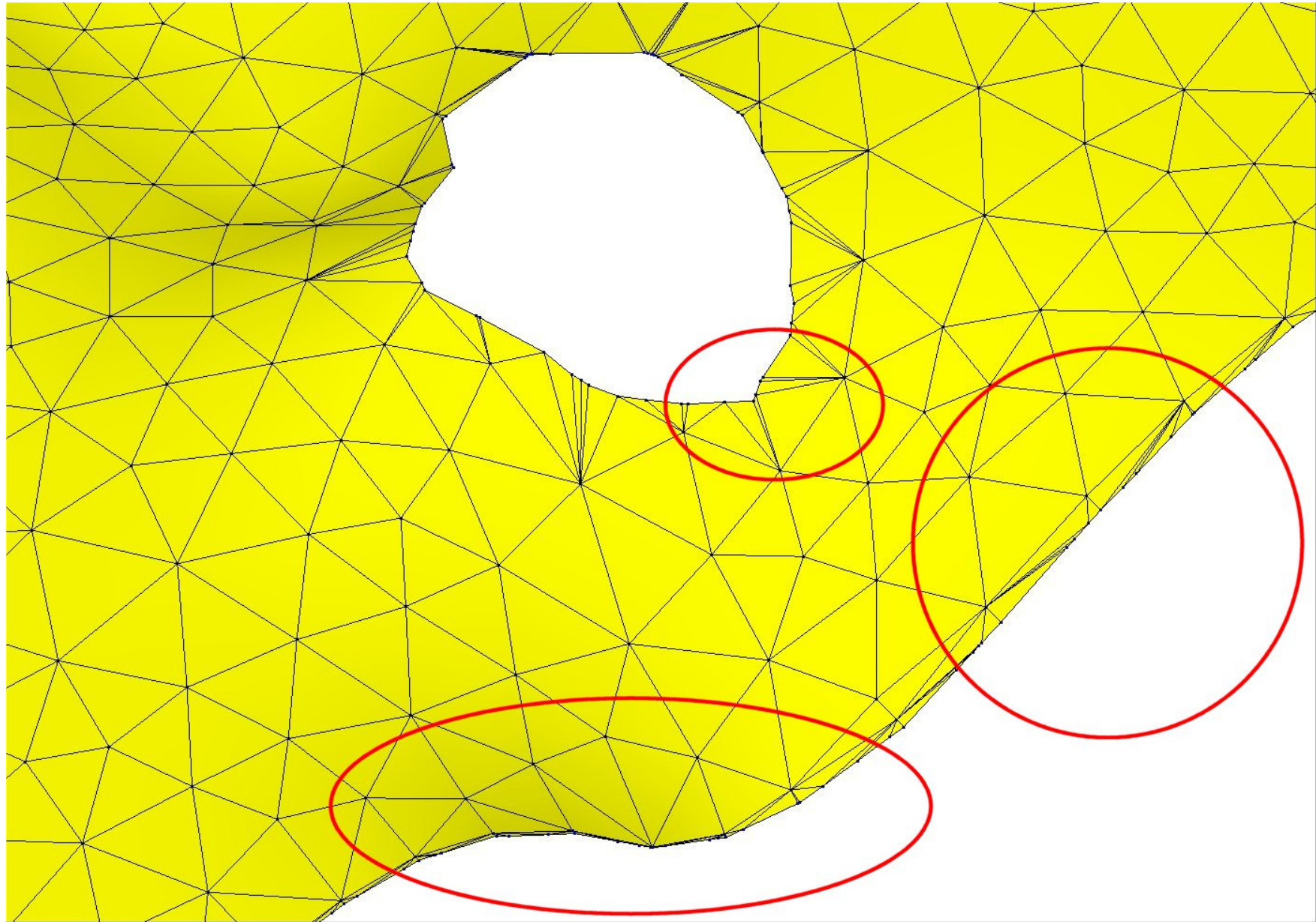

Example of surface re-triangulation

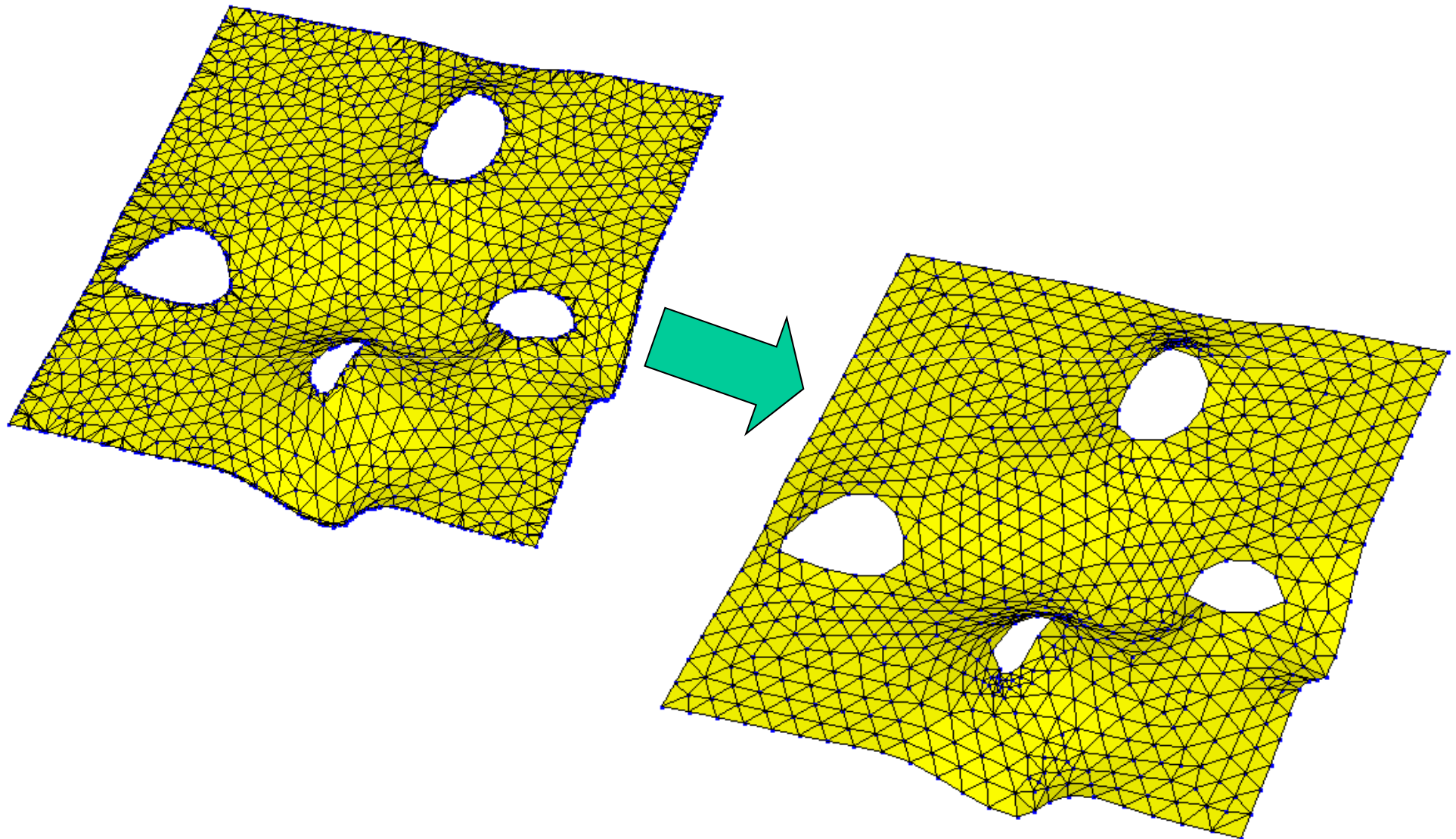

Unstructured mesh – Surface Meshing

- **Parametric Space Meshing**

- Elements formed in 2D using parametric representation of surface
- Distance and angles are distorted in parametric space
- Nodes locations later mapped to 3D space

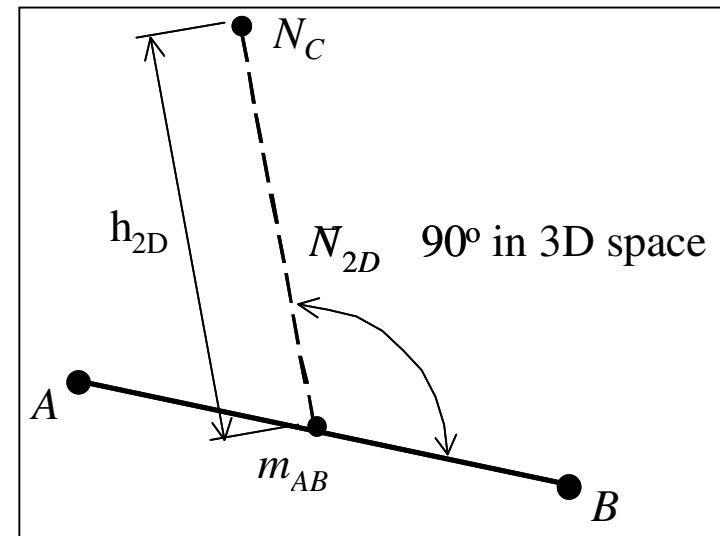
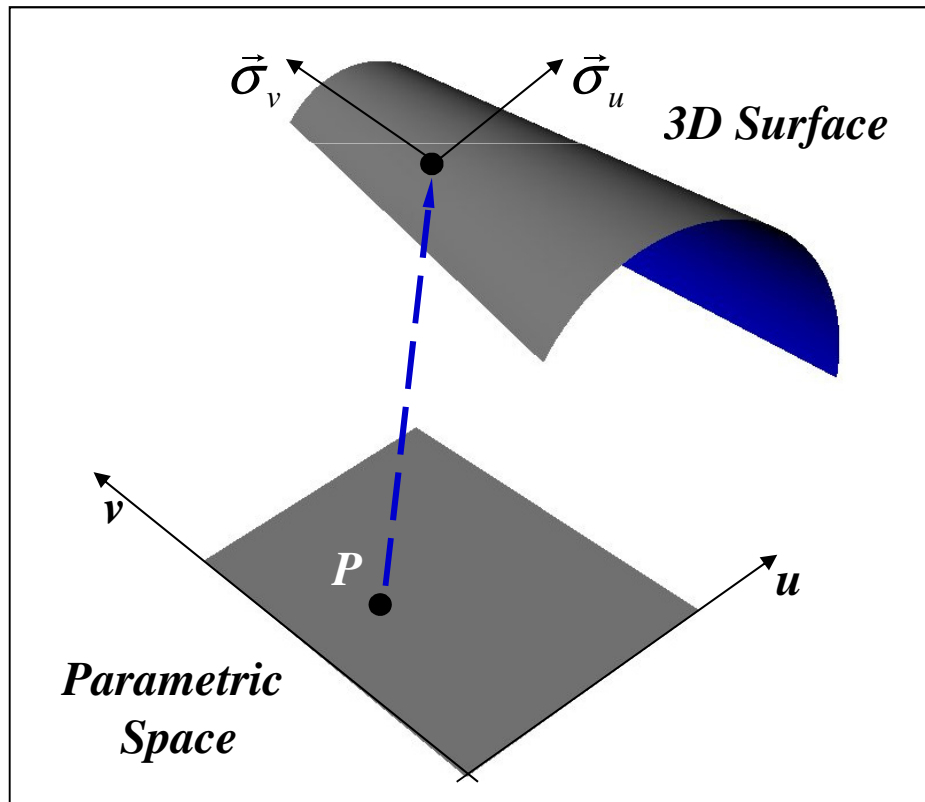

Unstructured mesh – Surface Meshing



- **Parametric Space Meshing**

- Given an analytical surface description and boundary segments

- **Background quadtree**

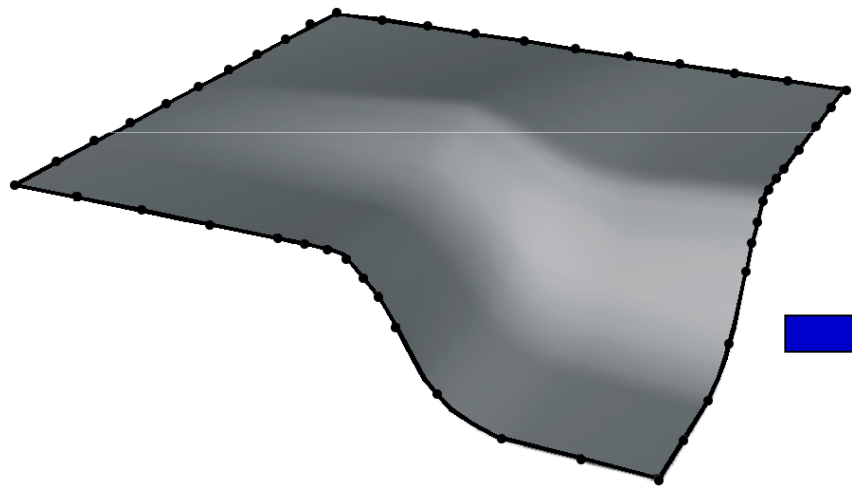

Metric Information

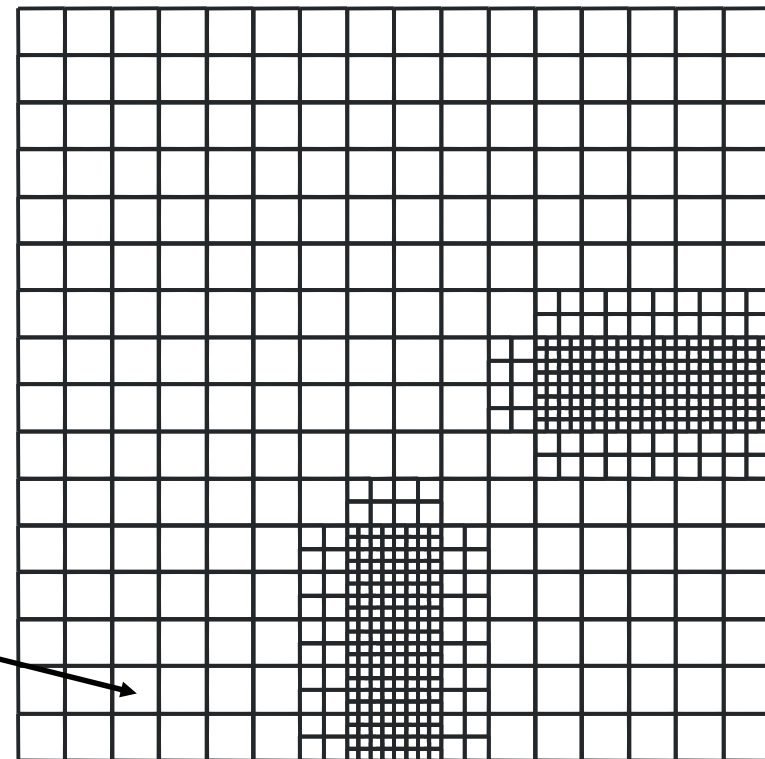

Importance of considering the curvature

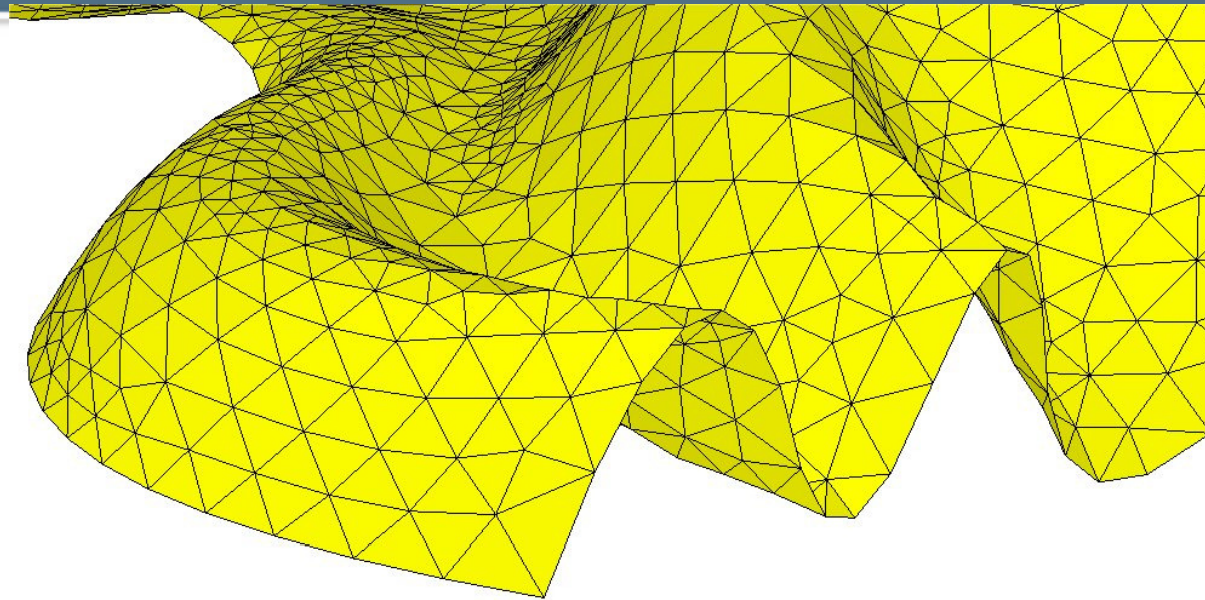

No consideration of curvature

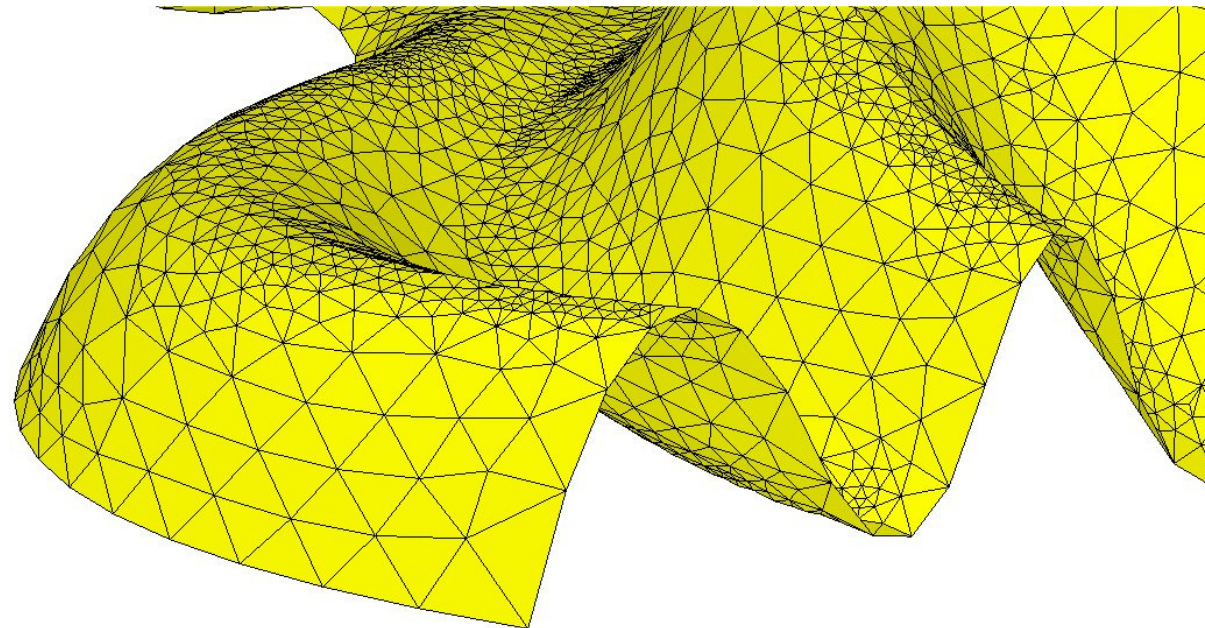

Consideration of curvature

Surface mesh intersection

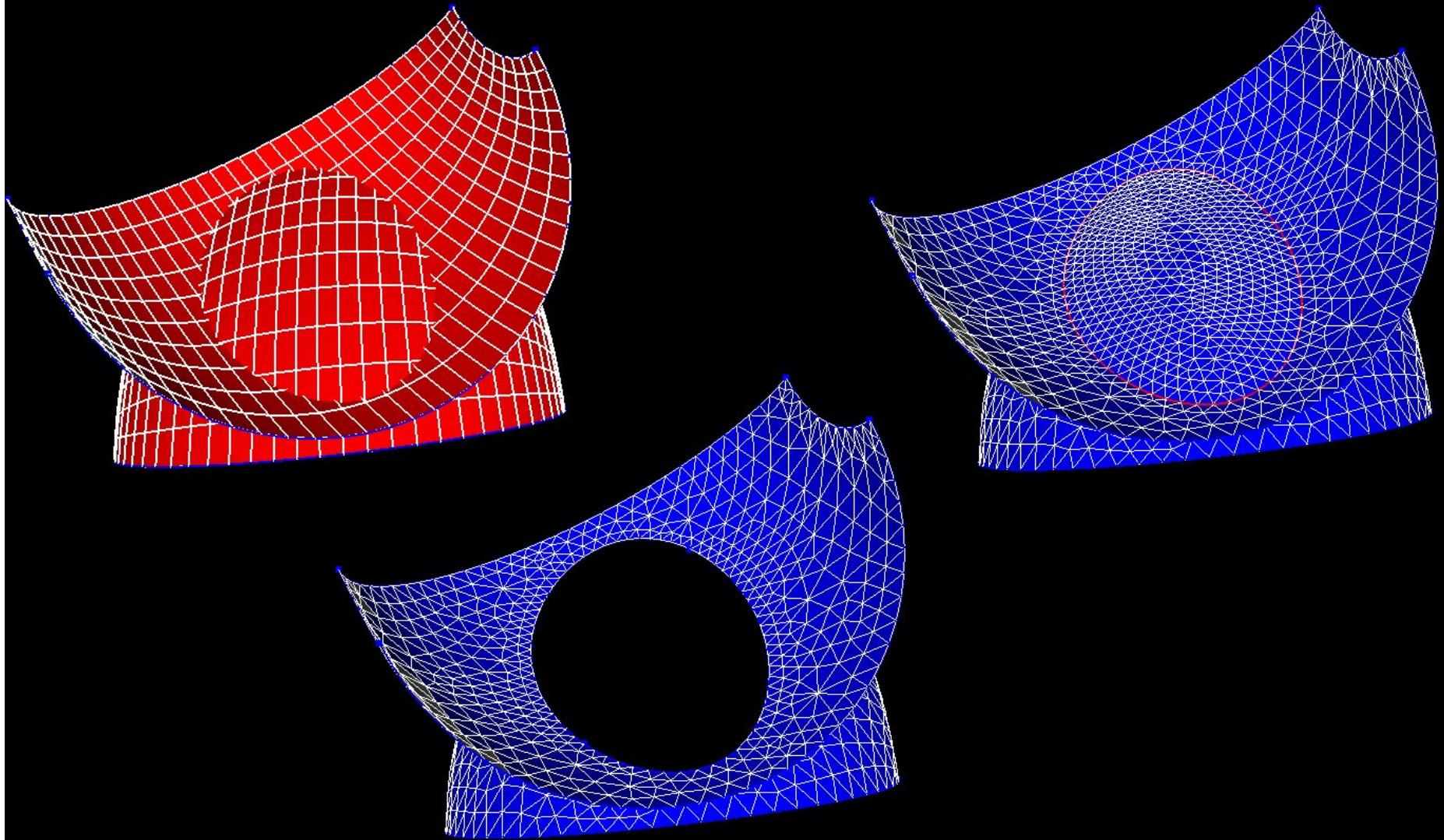

Surface intersection with exact arithmetic

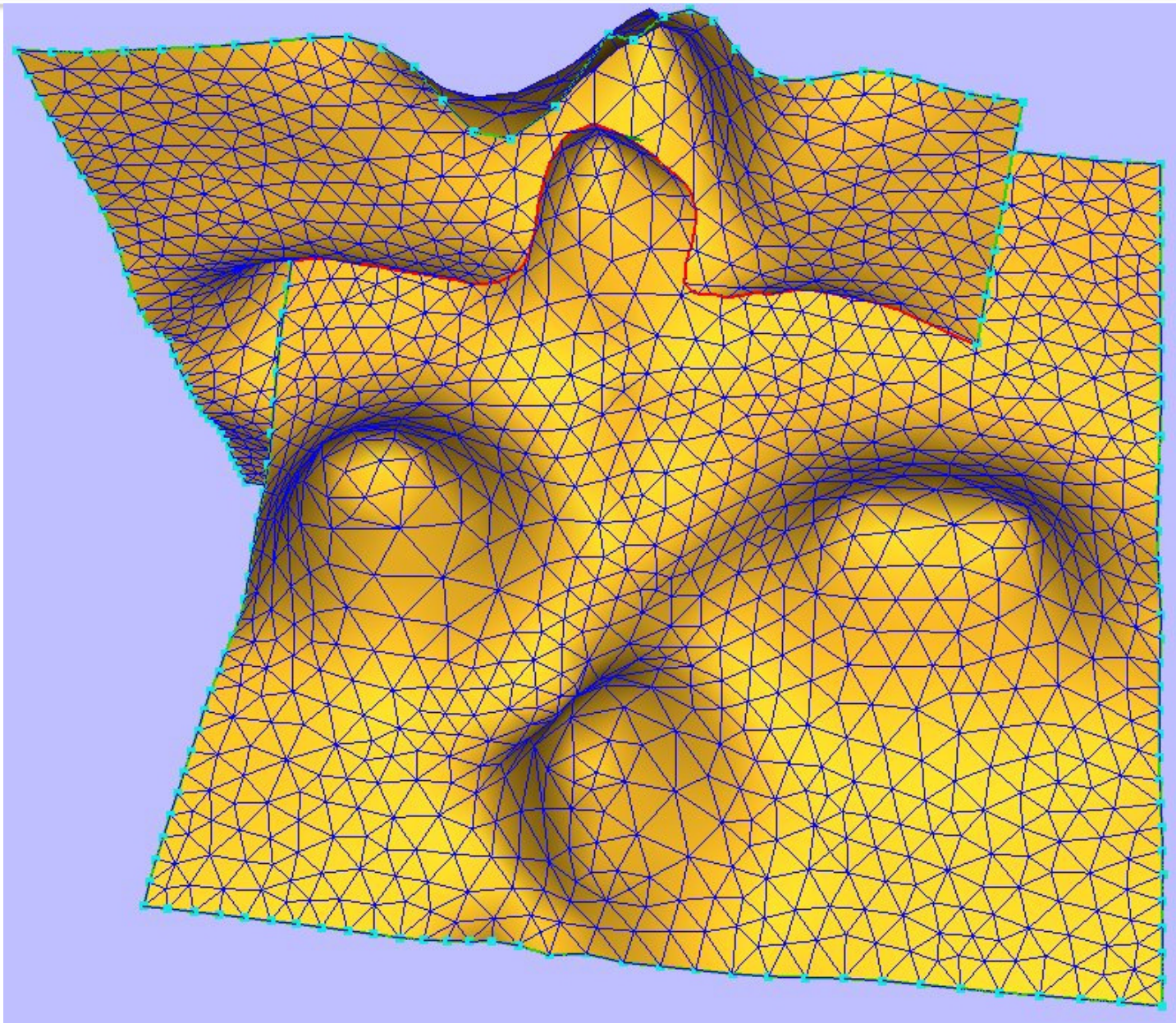

Surface intersection with exact arithmetic

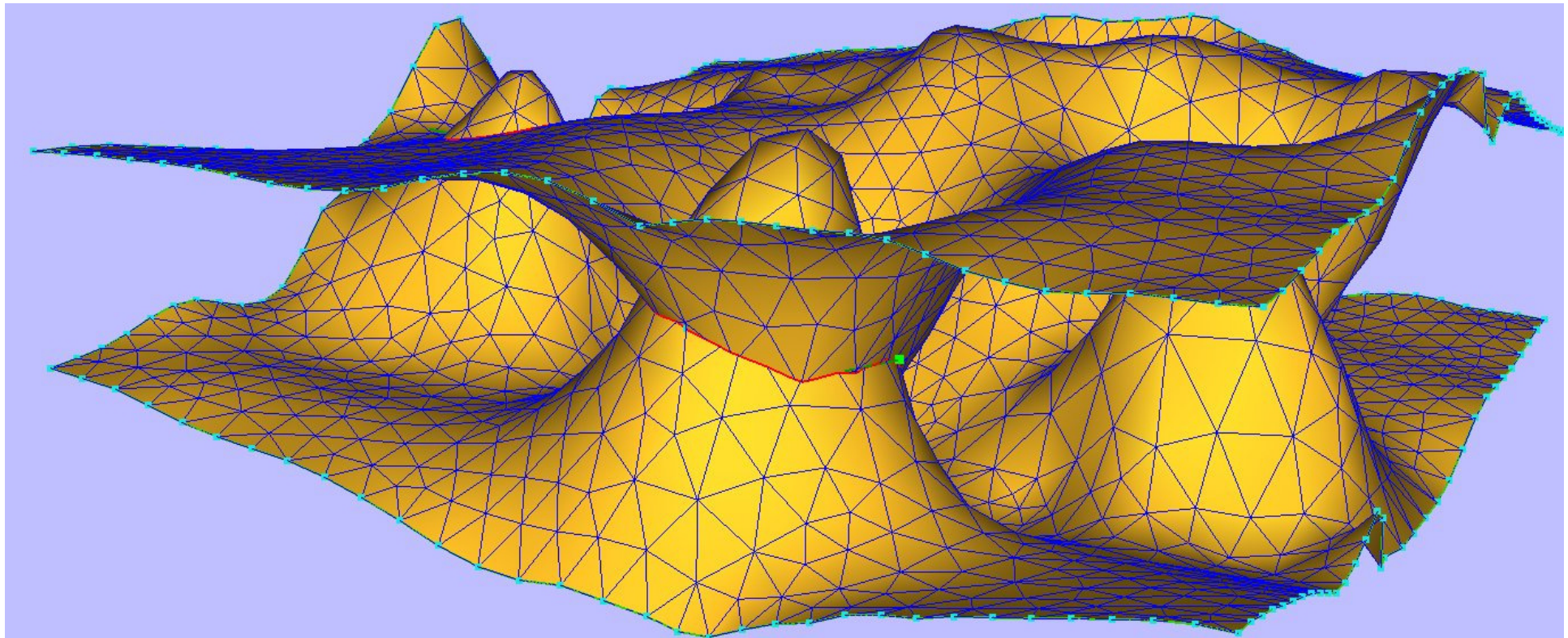

Surface intersection with exact arithmetic

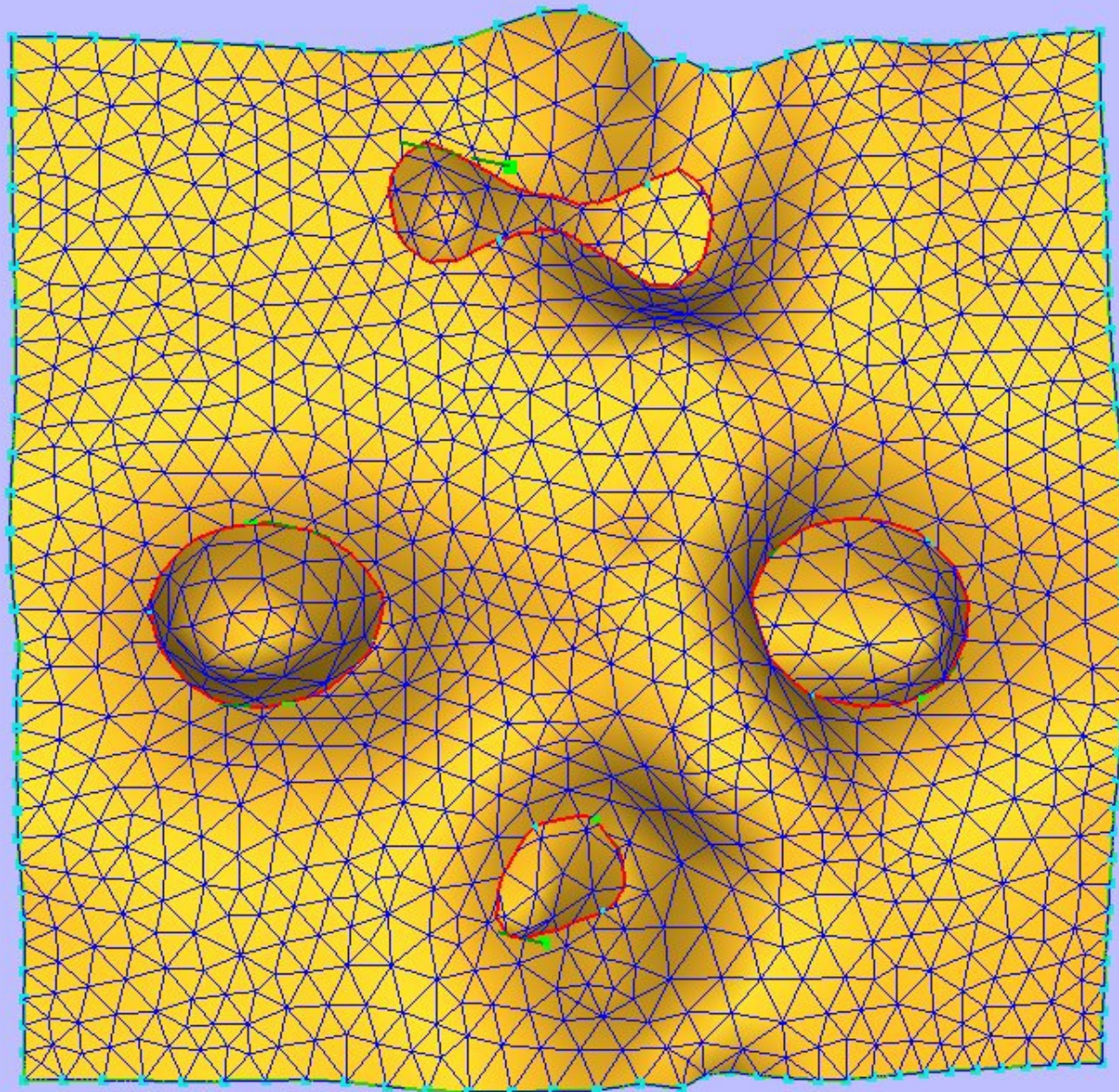

Surface intersection with exact arithmetic

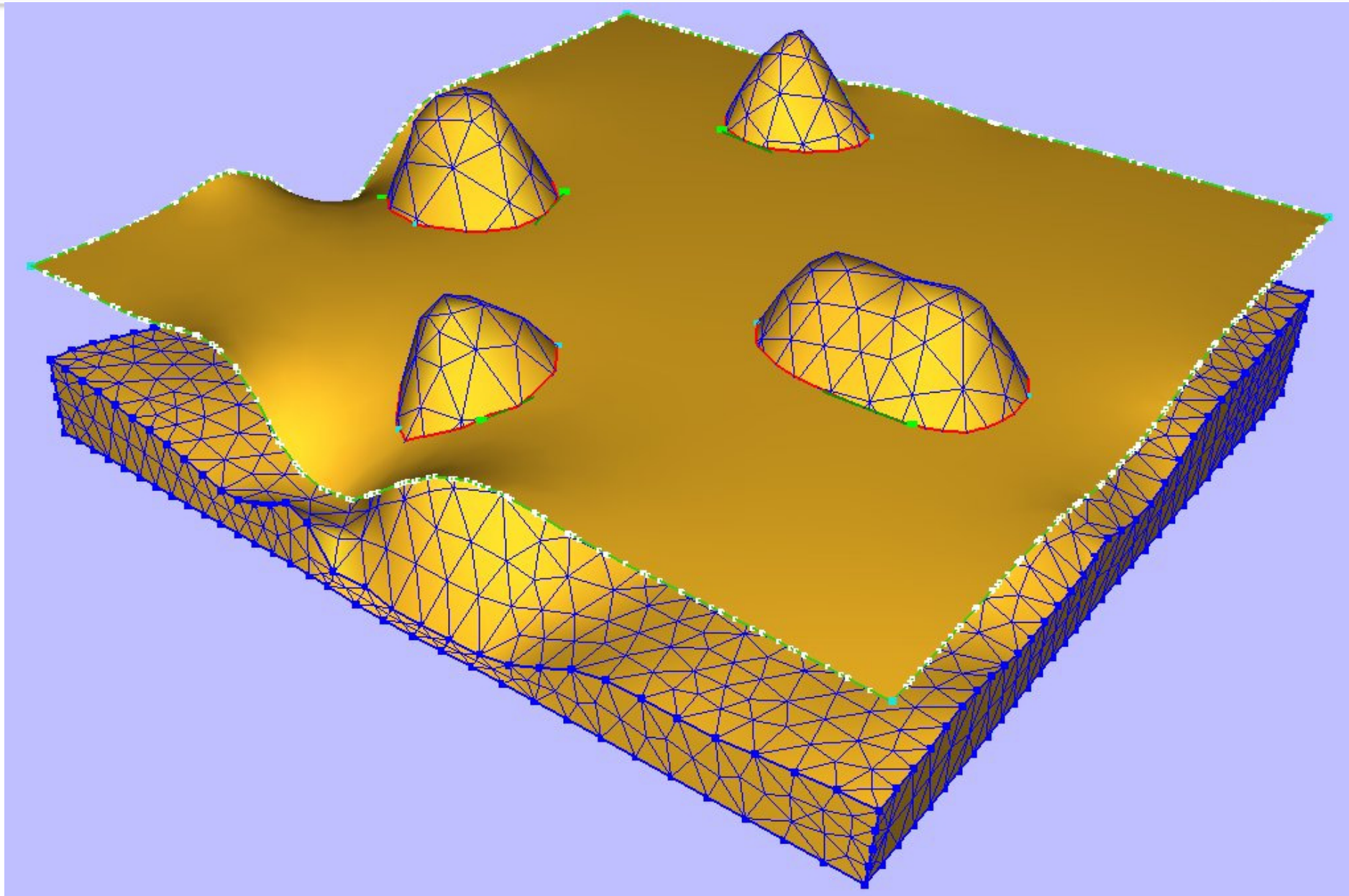

Case study: two-fault subsurface model

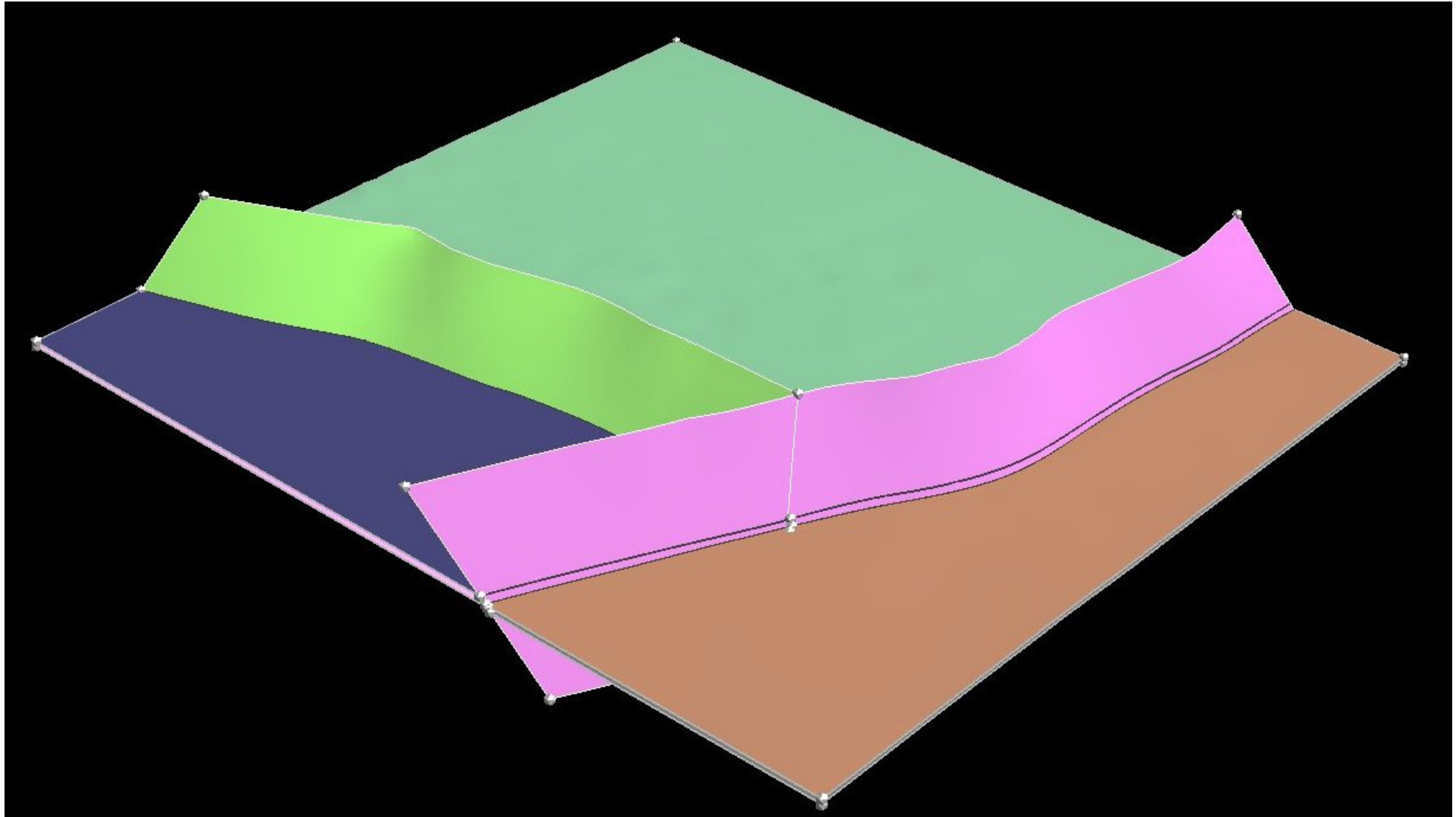

Original geological faults and limiting box

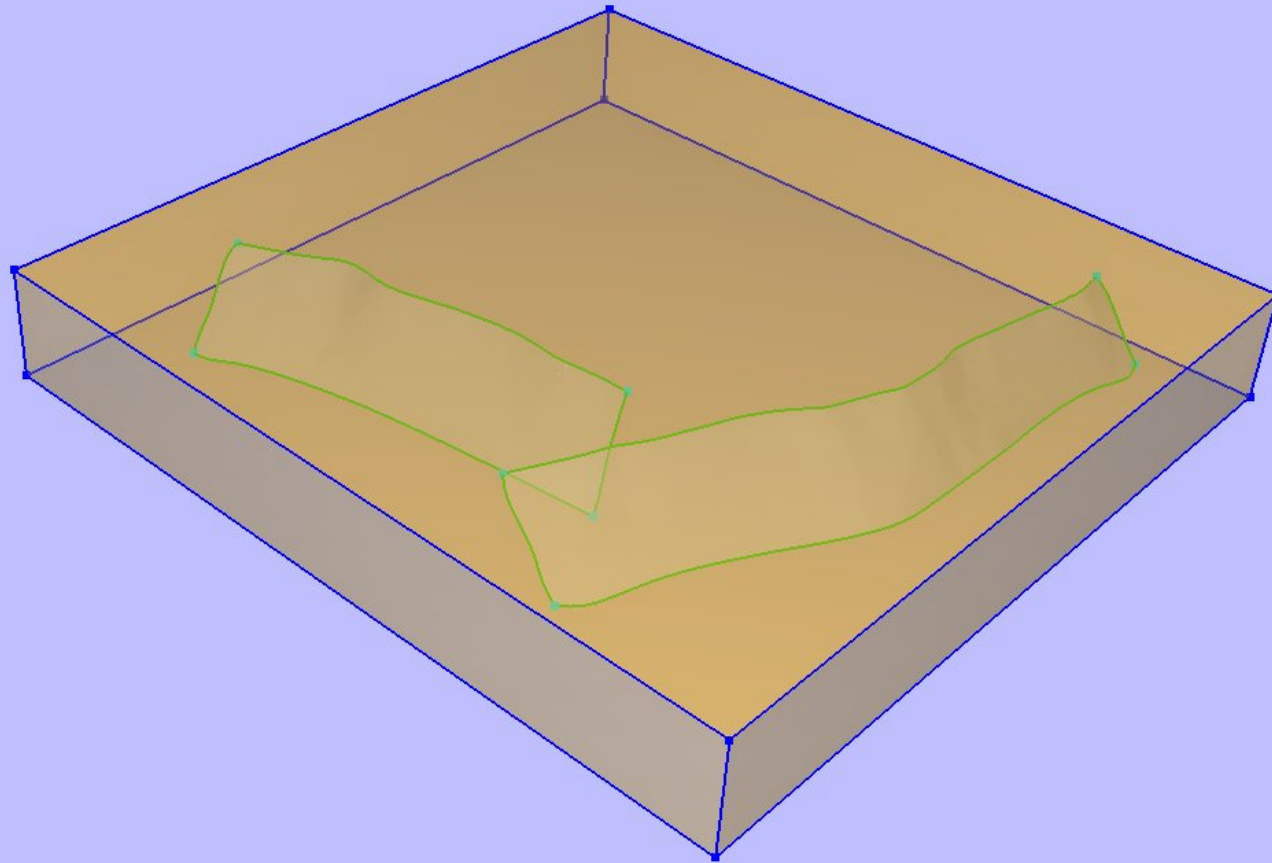

Support triangulation reconstruction

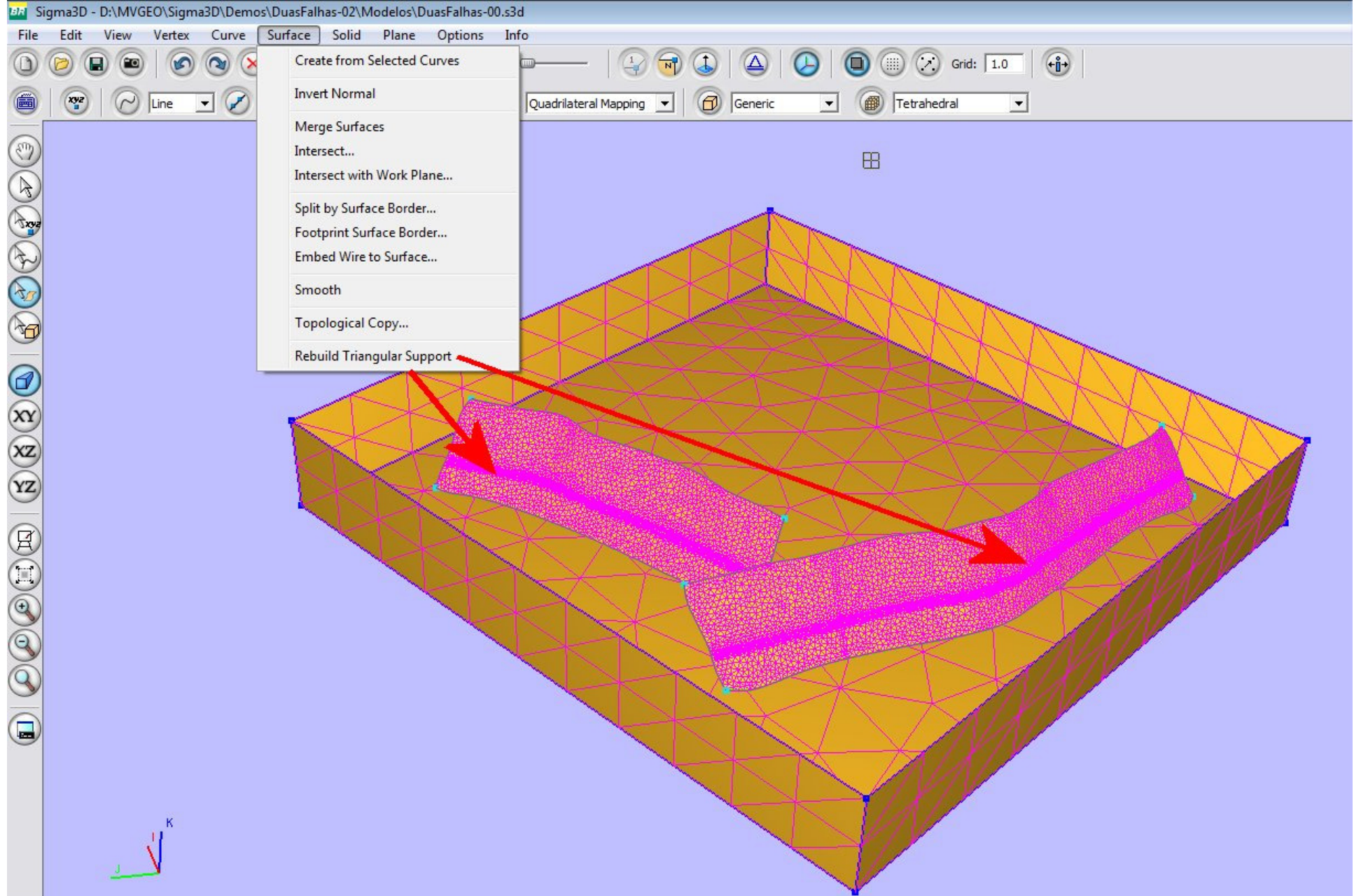

Support triangulation reconstruction

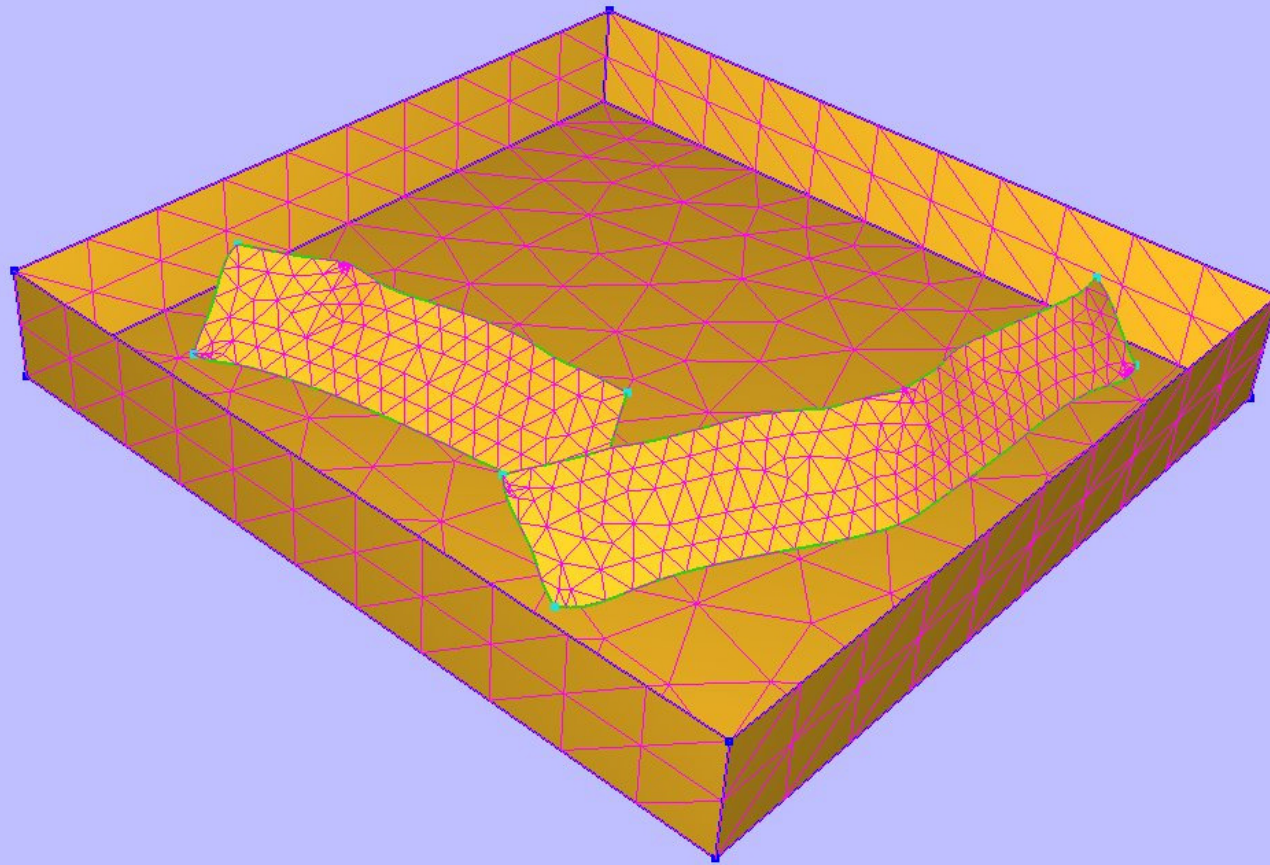

Split surface by surface border

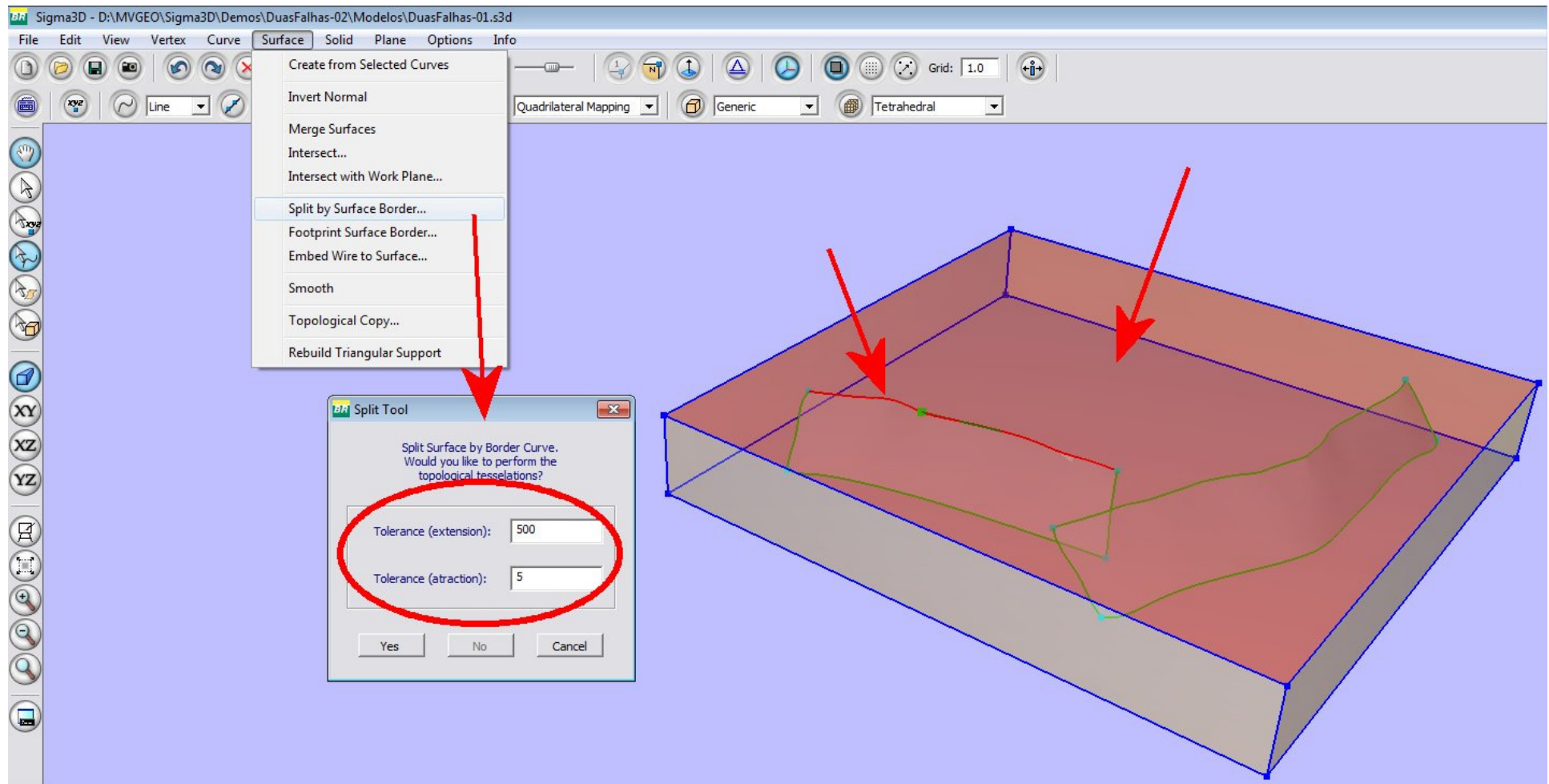

Surface split by extended surface border

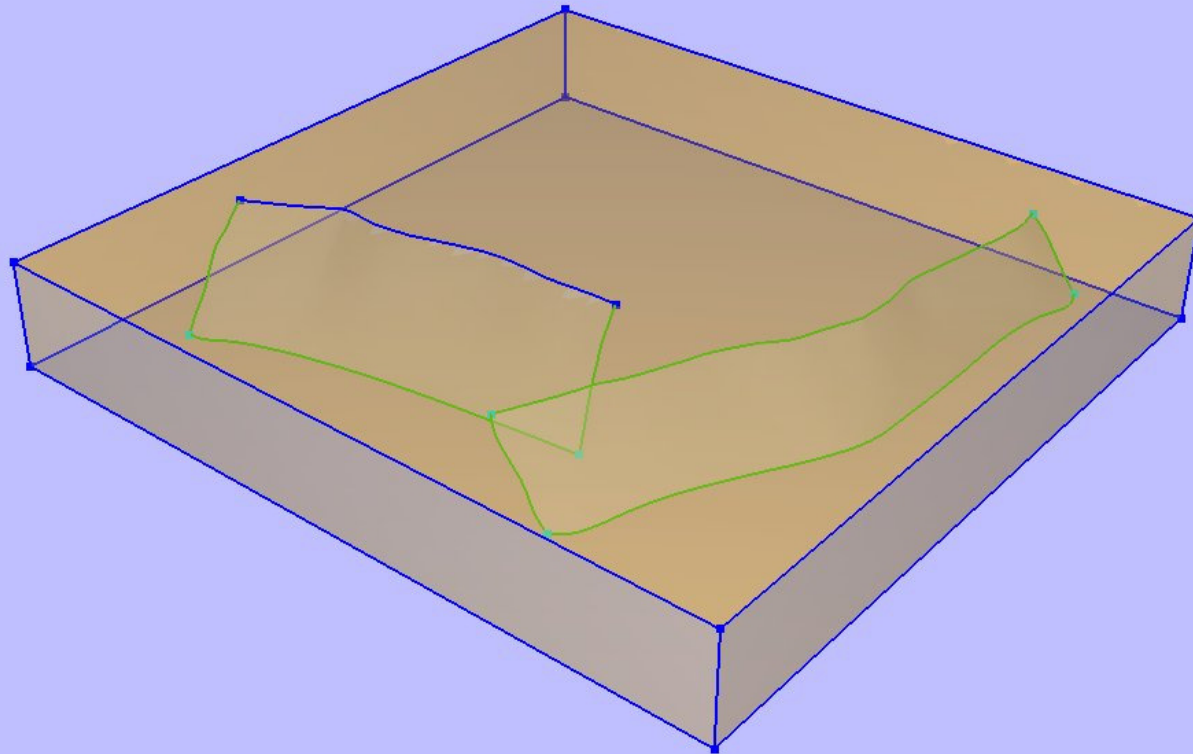

Split by surface border: fault extensions

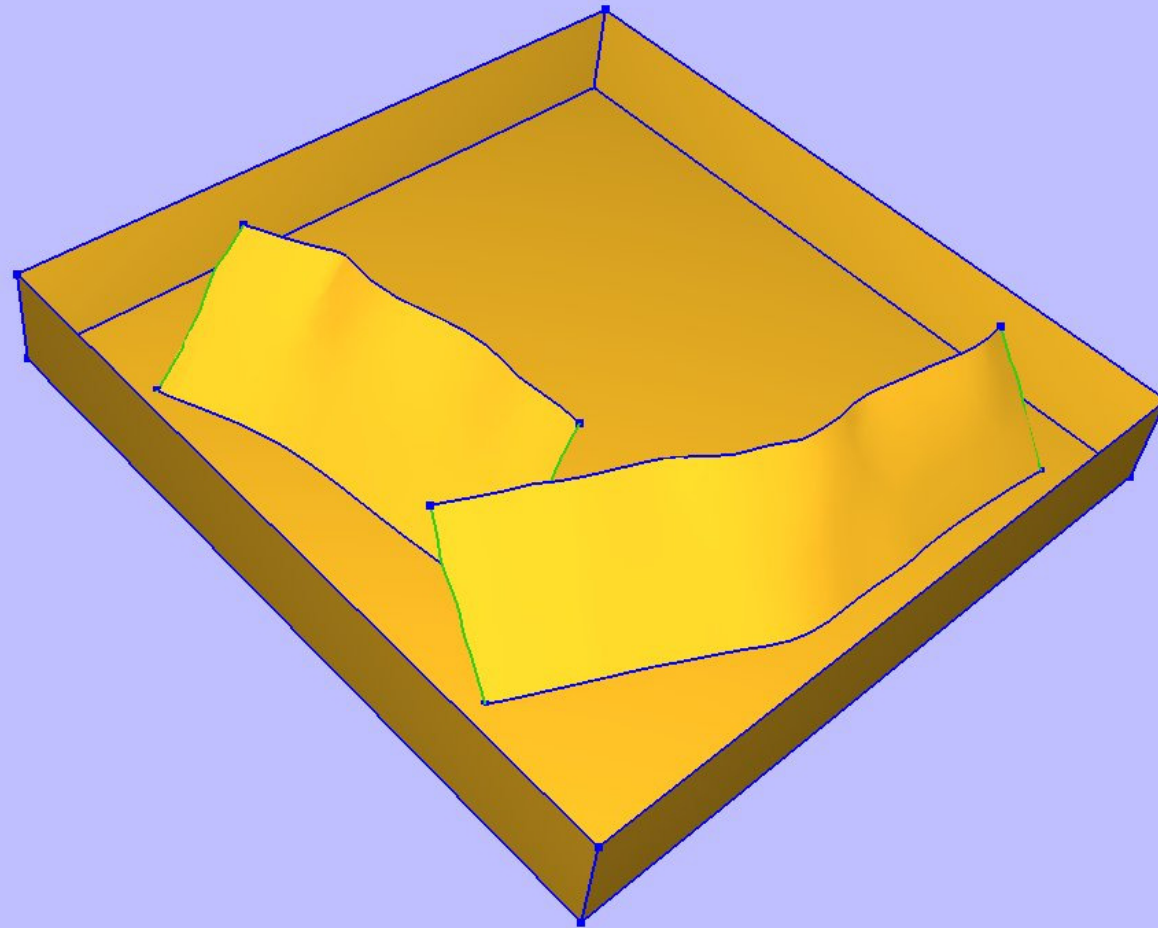

Extended faults: support triangulations

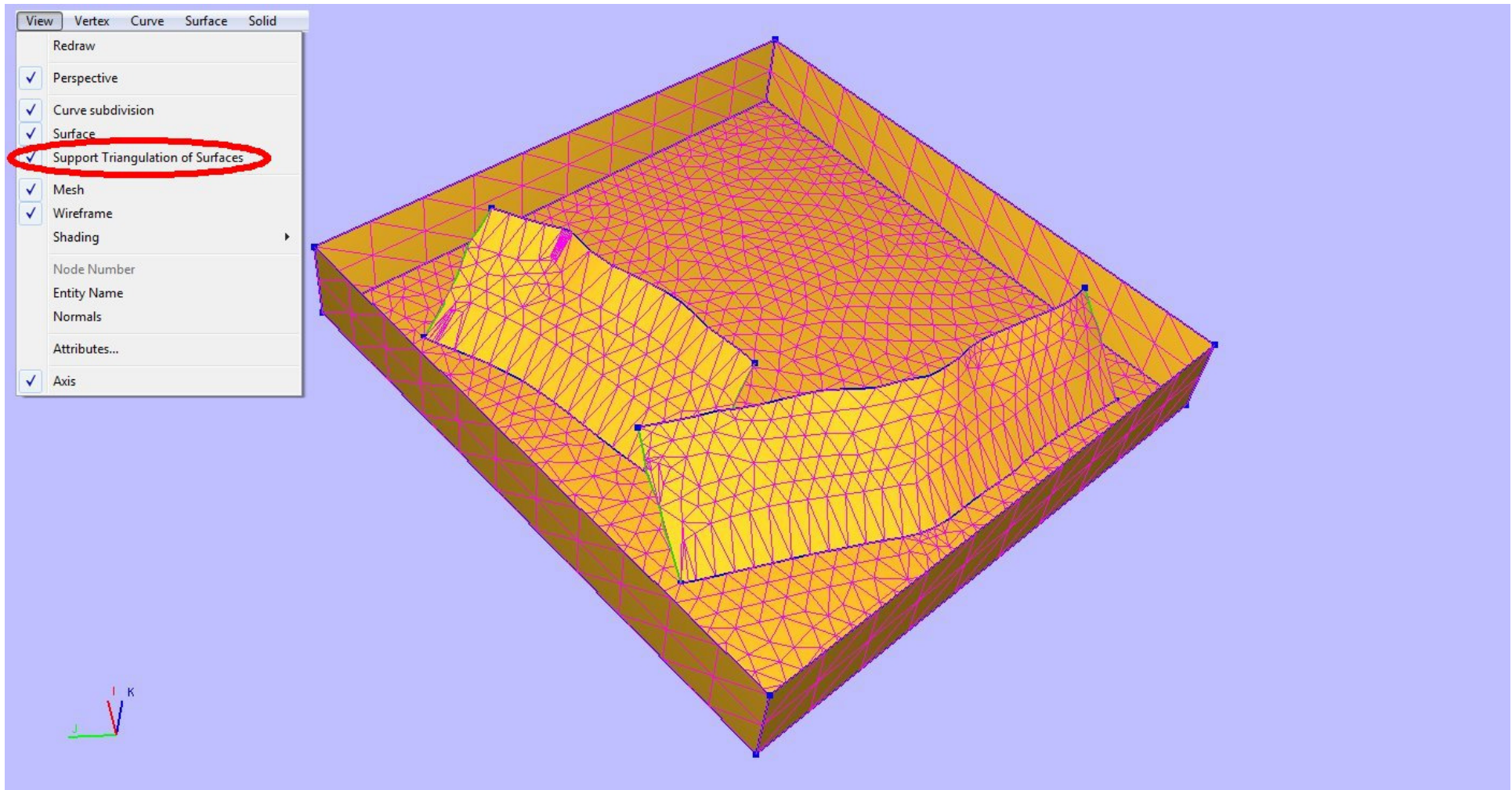

Support triangulation reconstruction



- Surface
 - Solid
 - Plane
 - Options
- Create from Selected Curves
 - Invert Normal
 - Merge Surfaces
 - Intersect...
 - Intersect with Work Plane...
 - Split by Surface Border...
 - Footprint Surface Border...
 - Embed Wire to Surface...
 - Smooth
 - Topological Copy...
 - Rebuild Triangular Support**

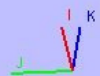
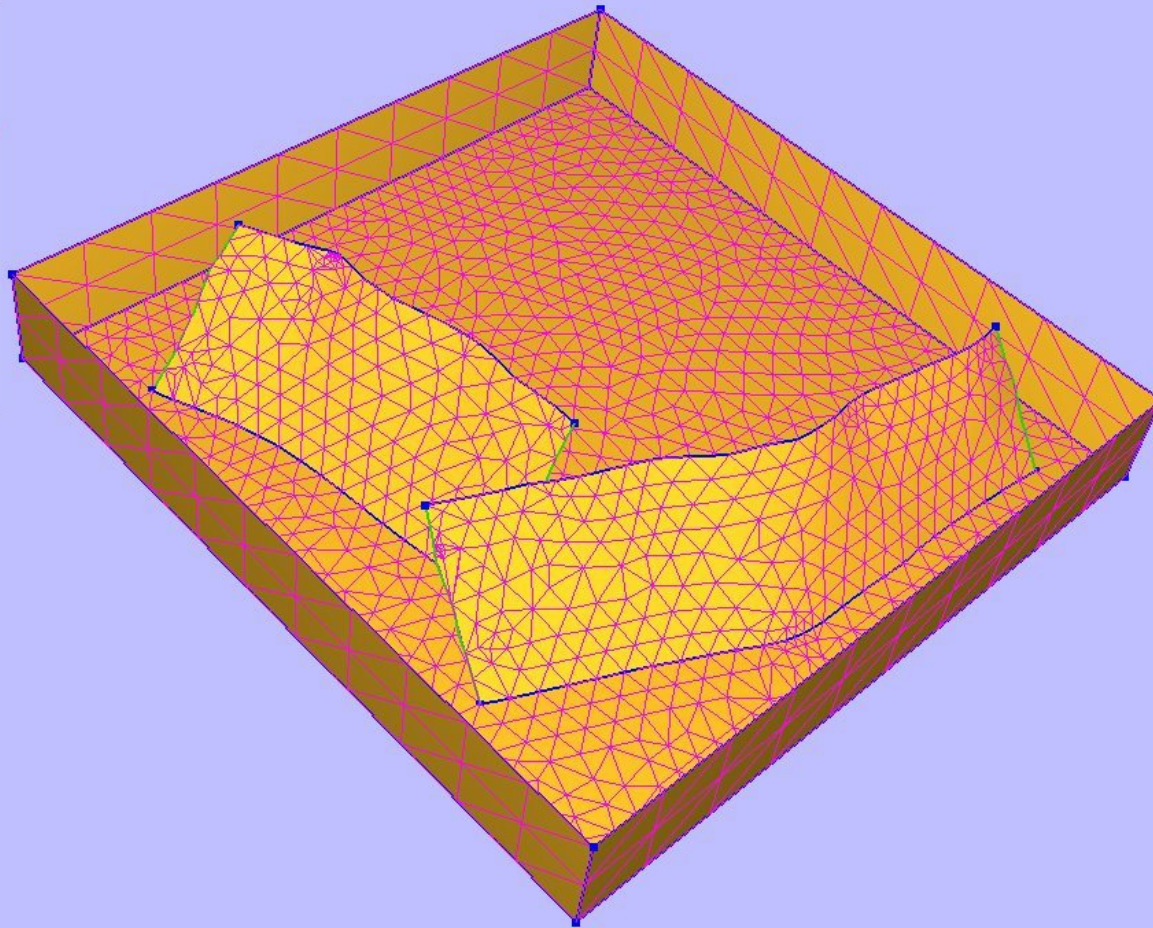

Curve insertion of surfaces

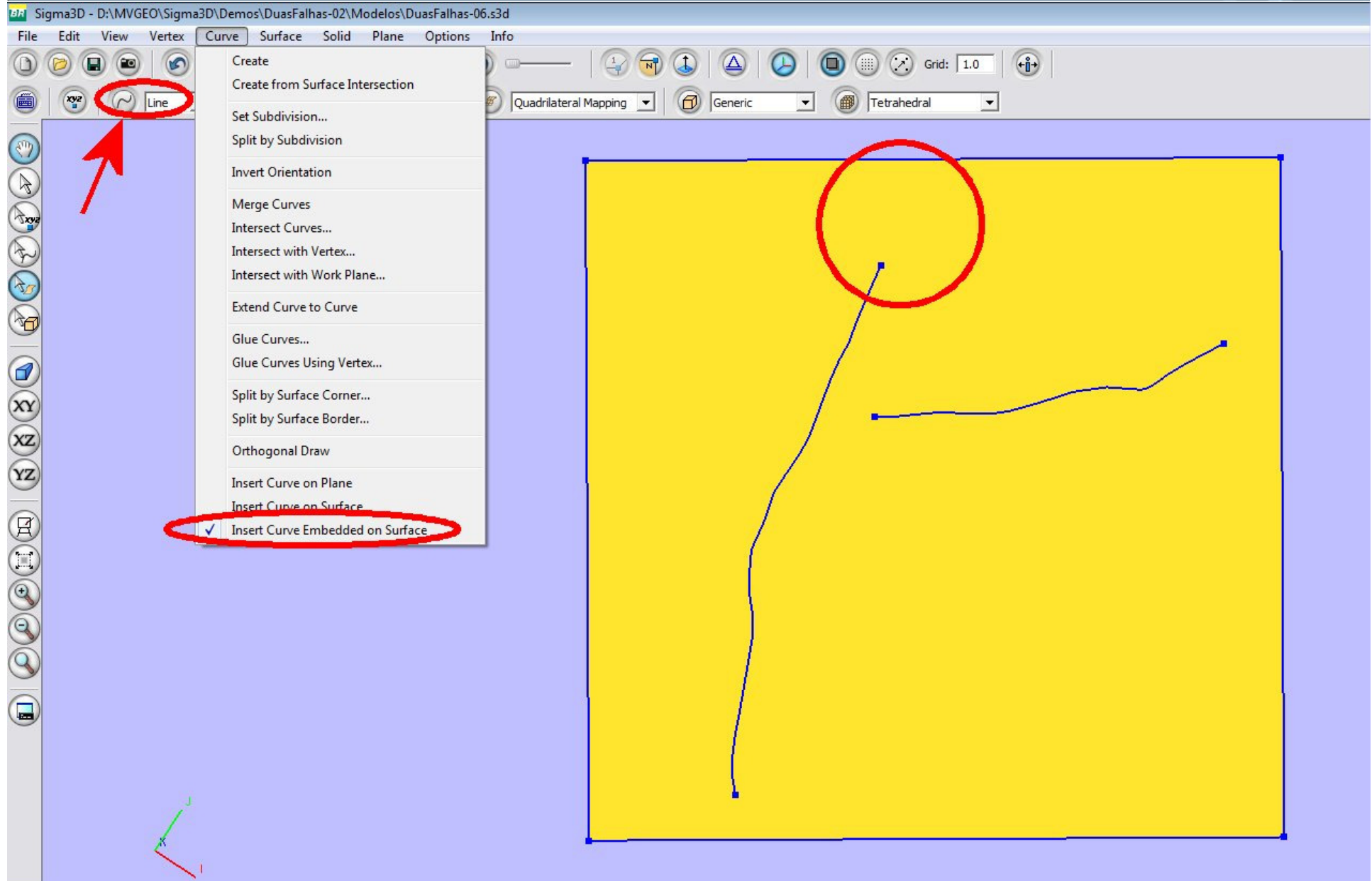

Curve insertion of surfaces



Curve insertion of surfaces

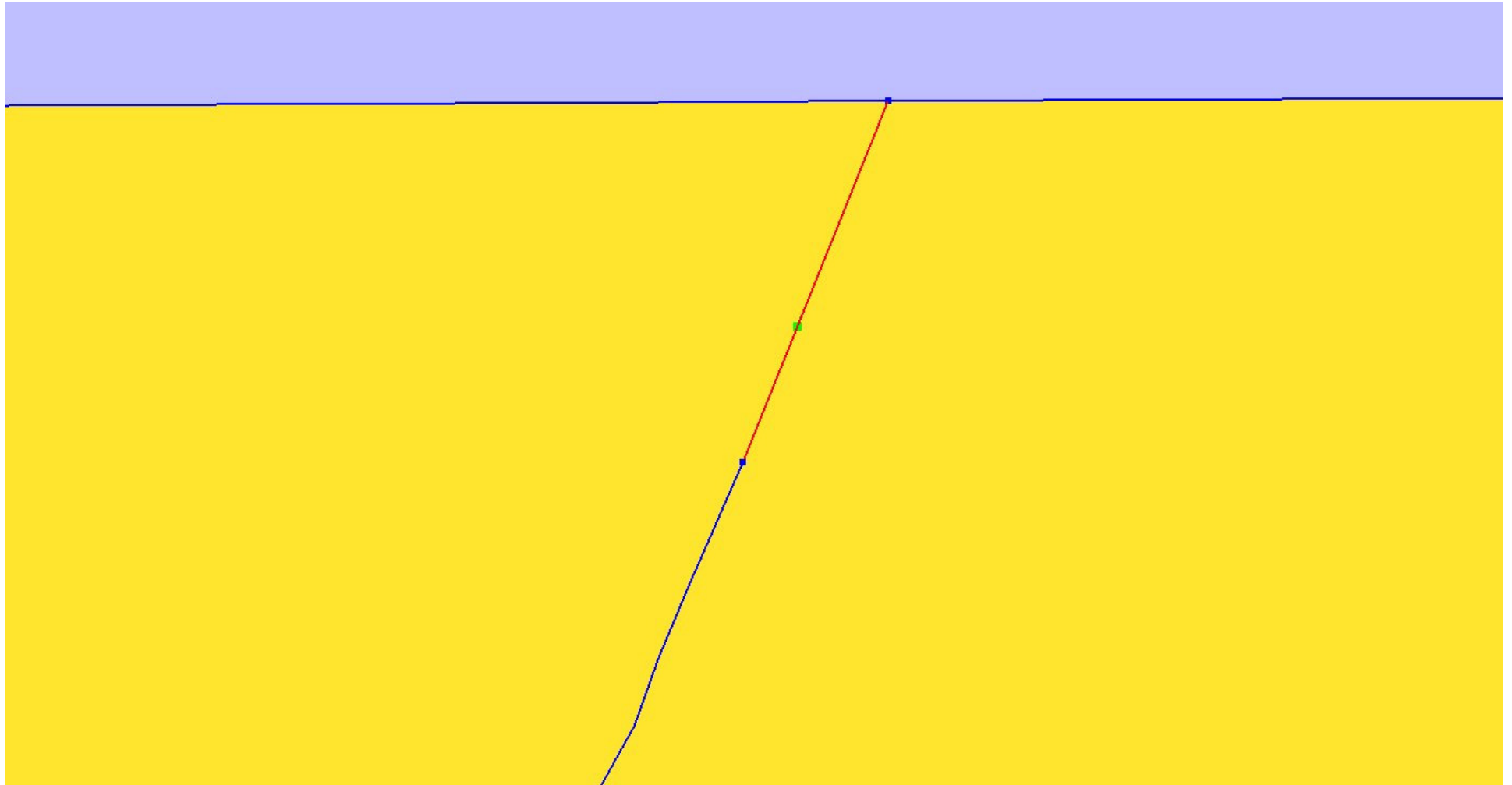

Support triangulation reconstruction

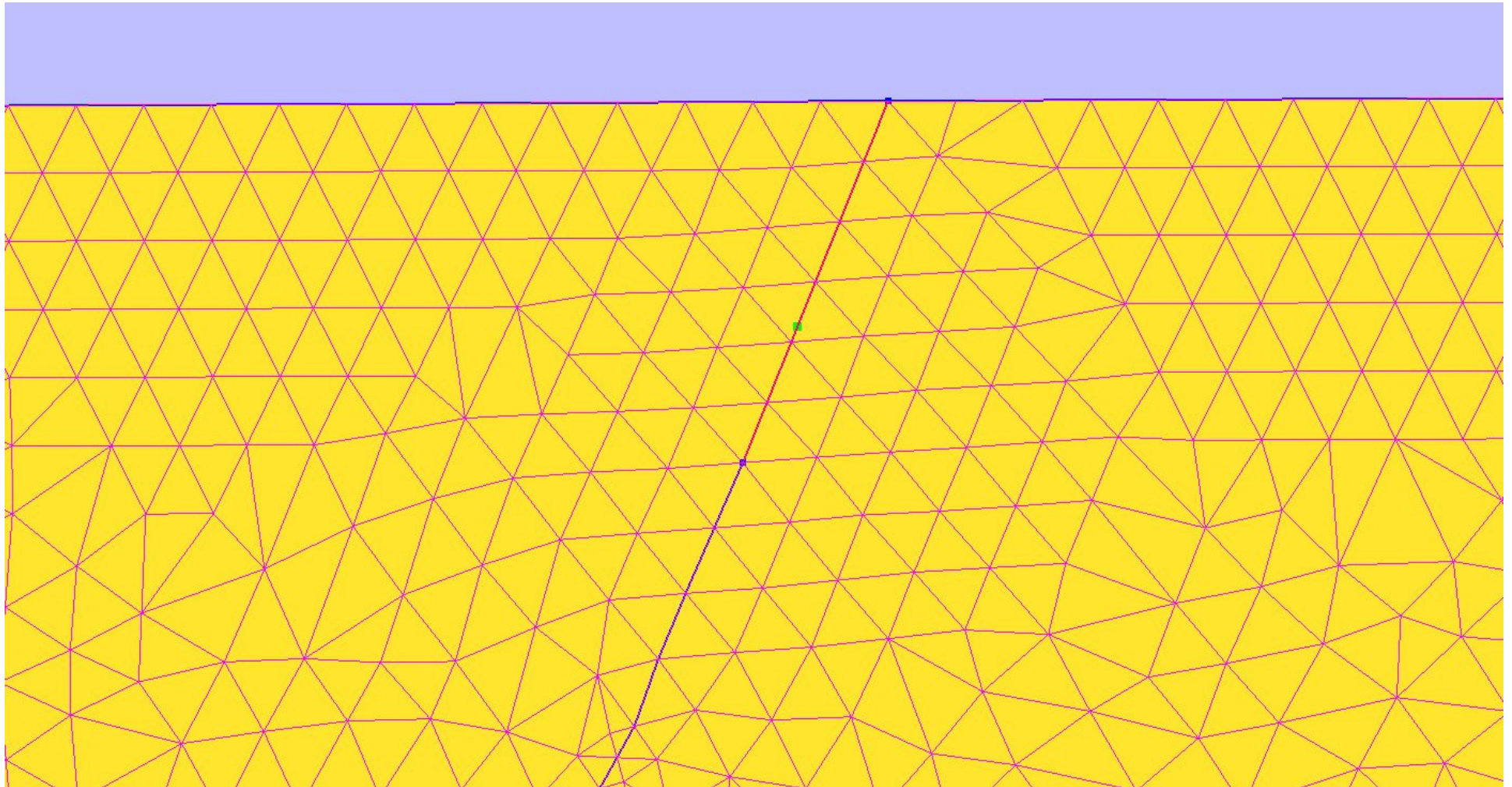

Curve insertion of surfaces

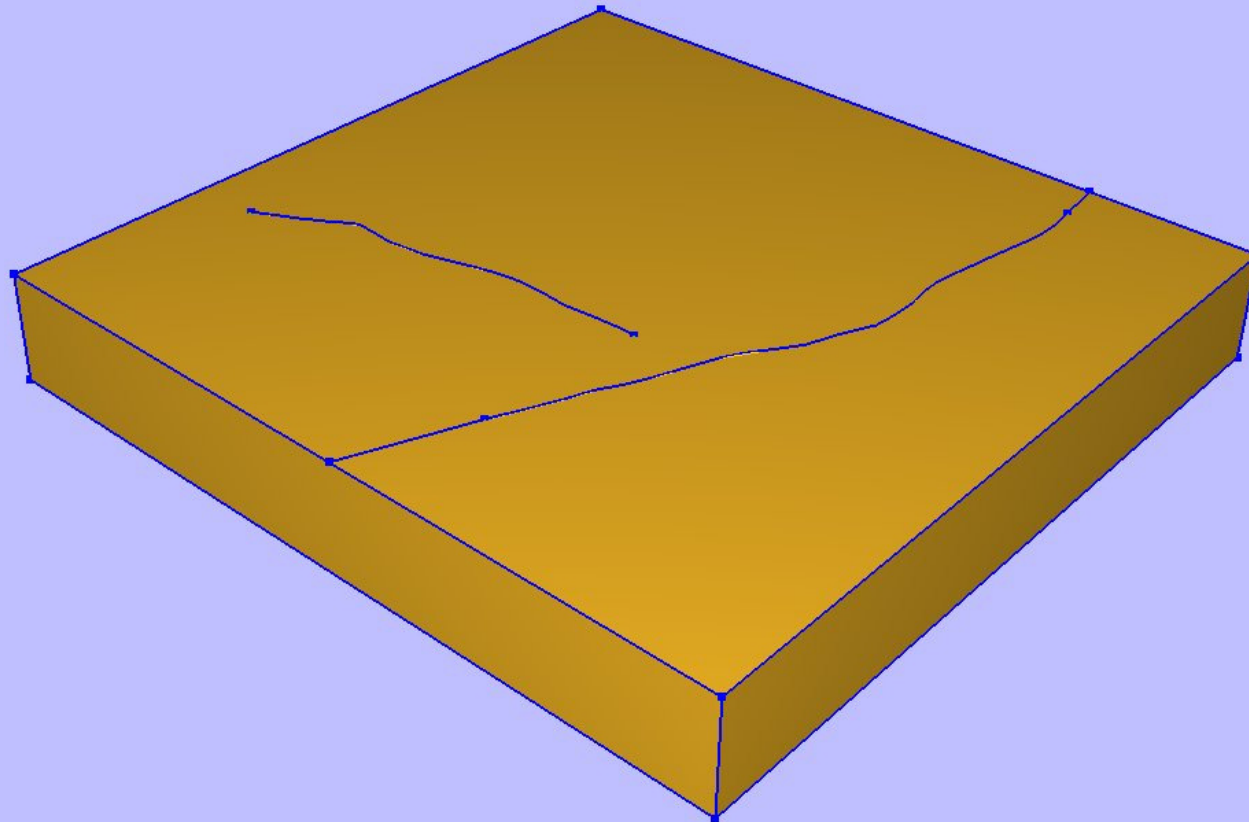

Support triangulation reconstruction

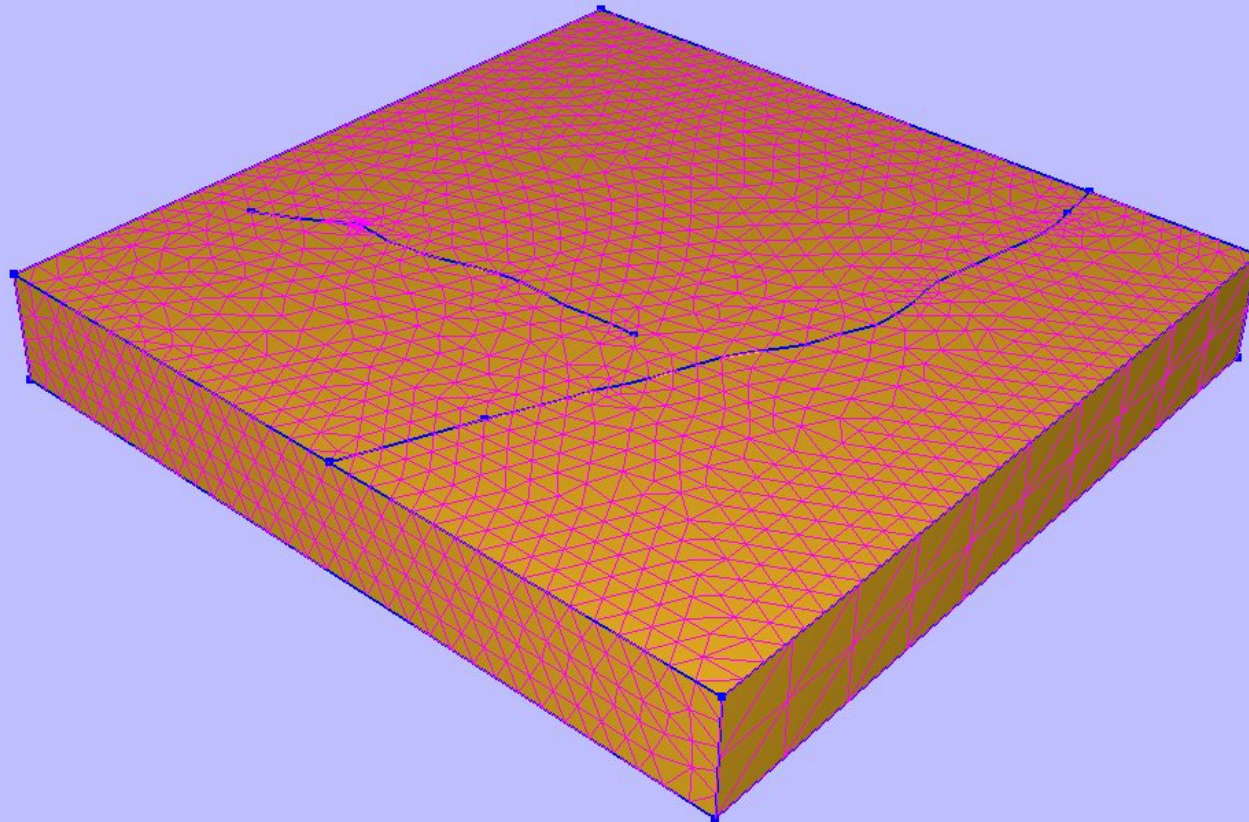

Creation of a new surface patch

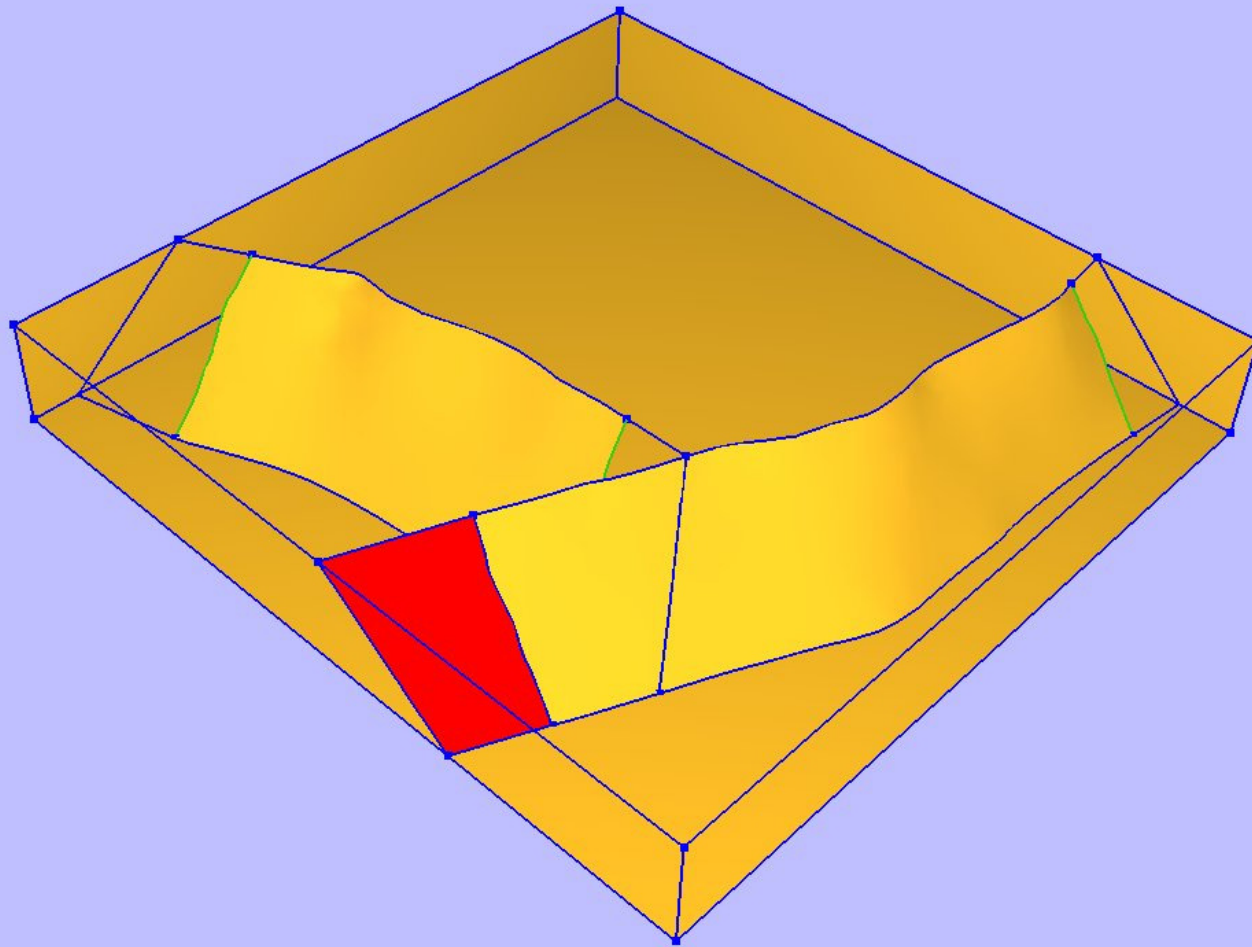

New patch: support triangulation

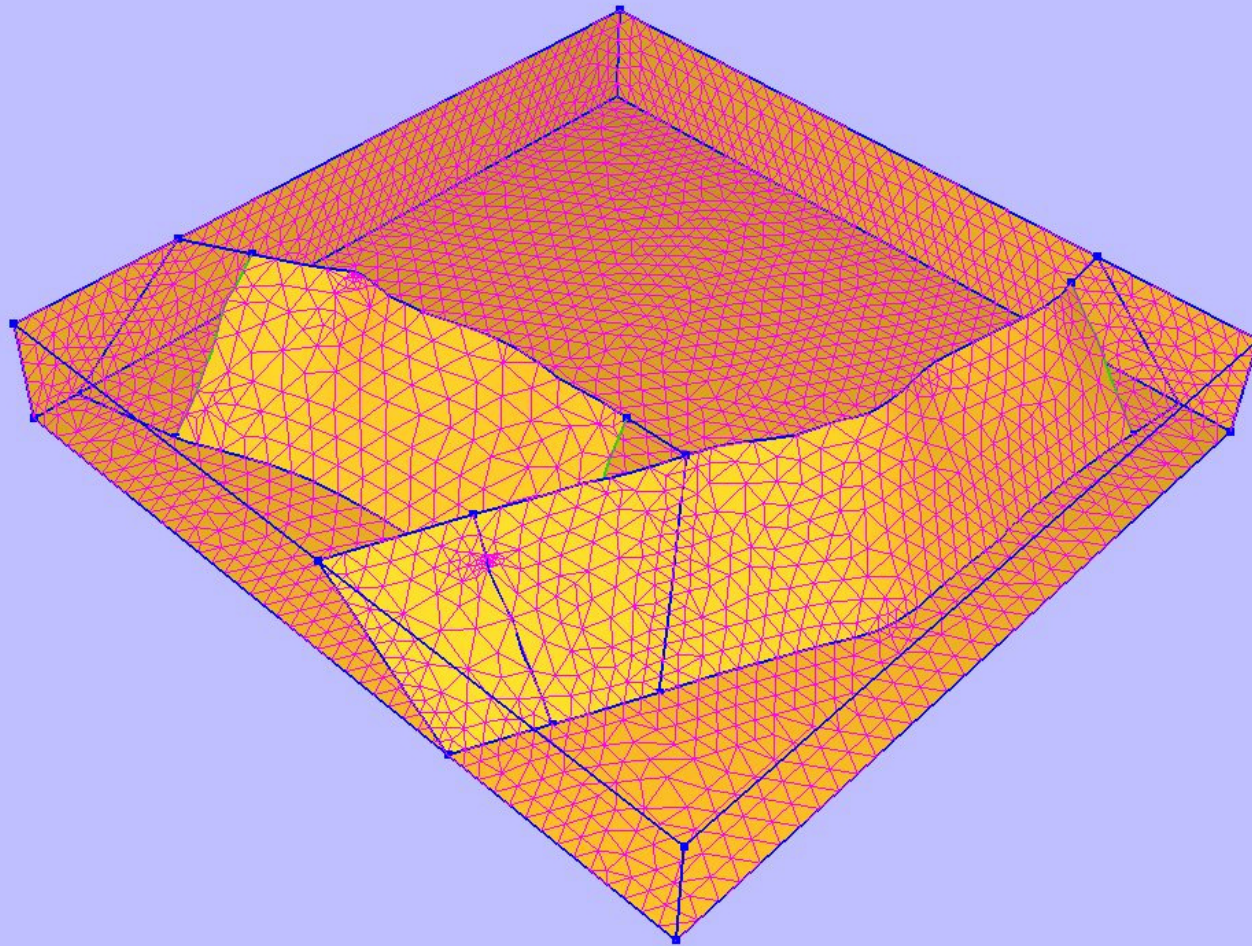

New surface patches

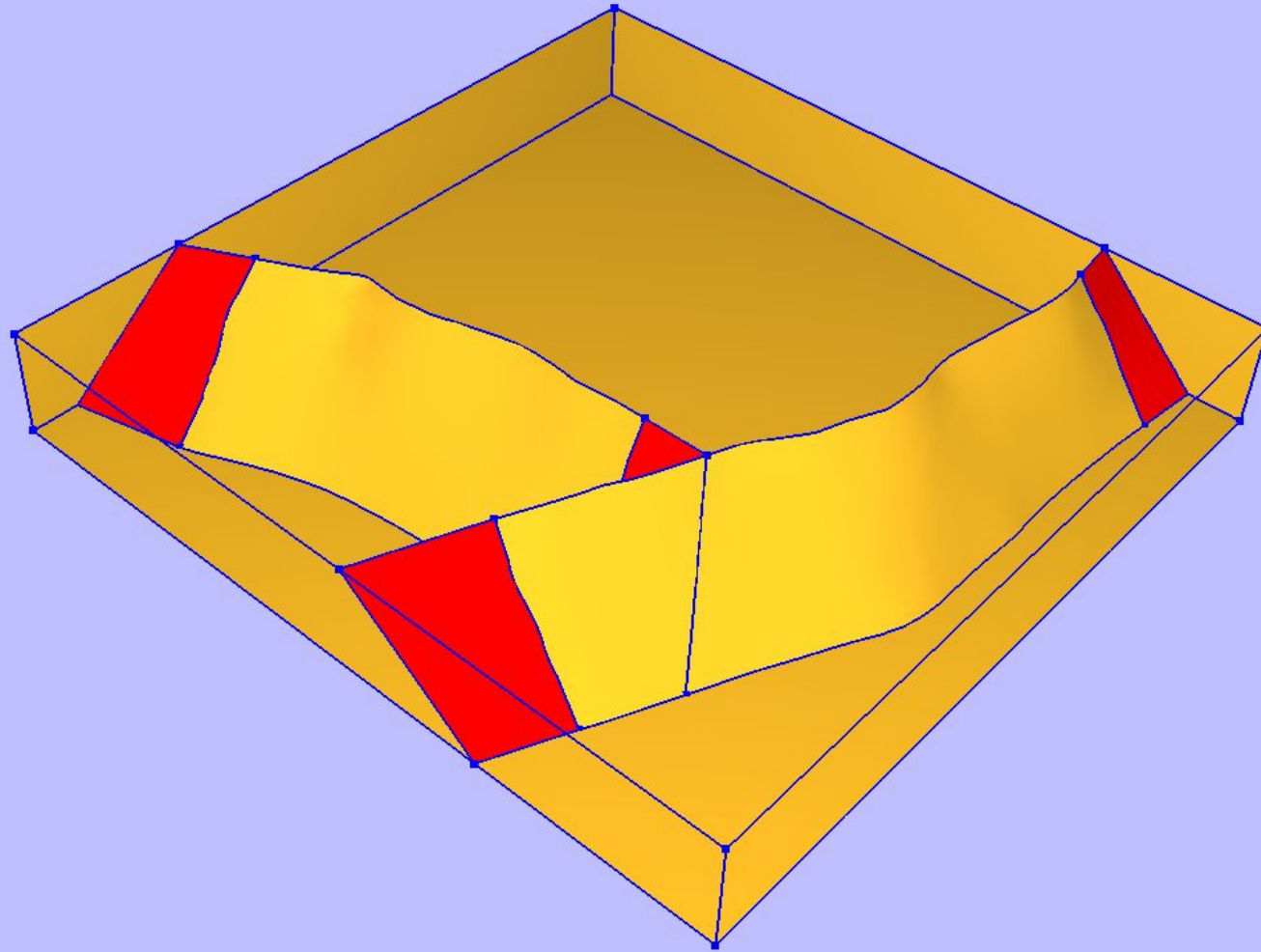

Support triangulations

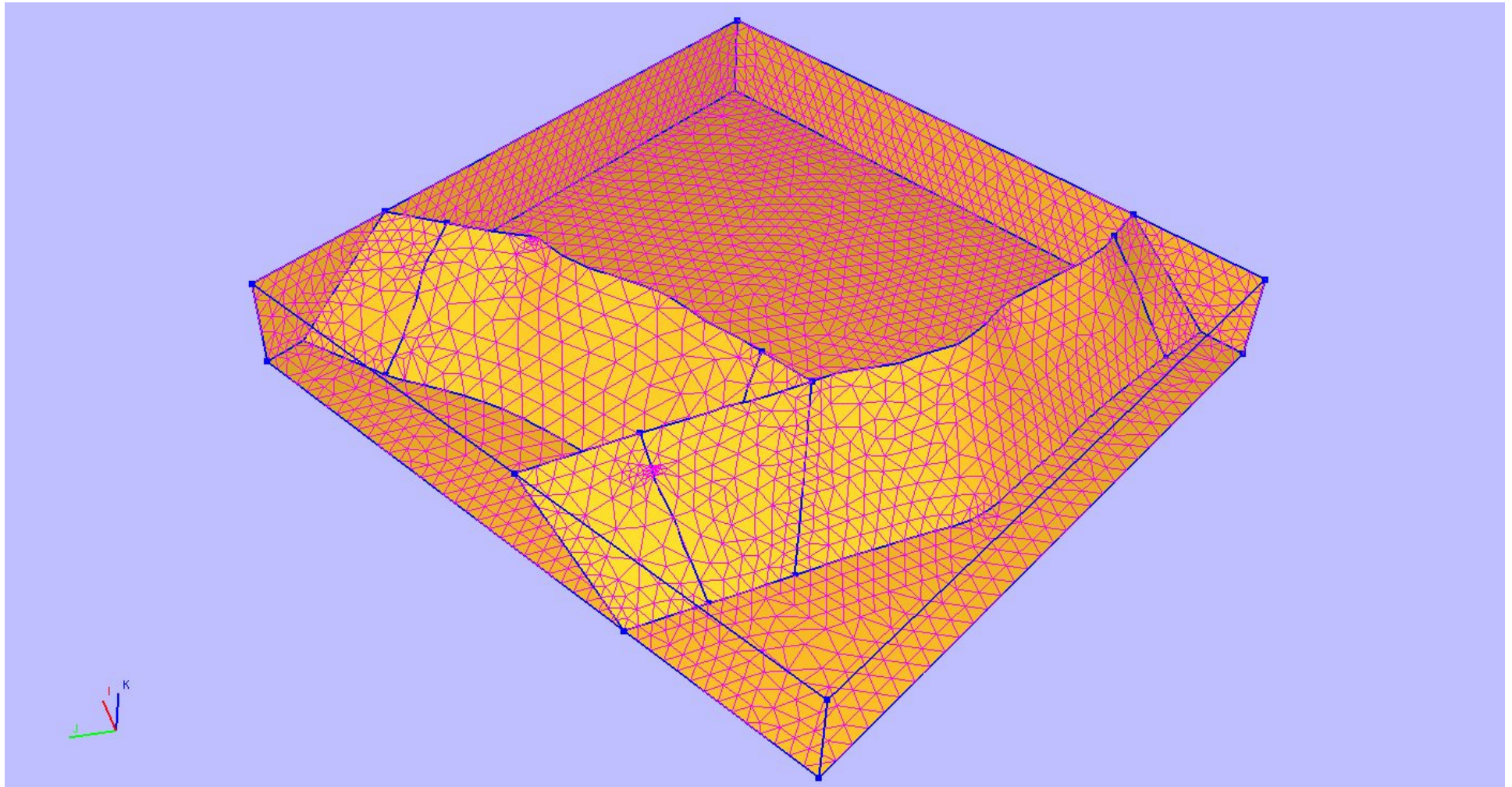

Geological horizon adjustments

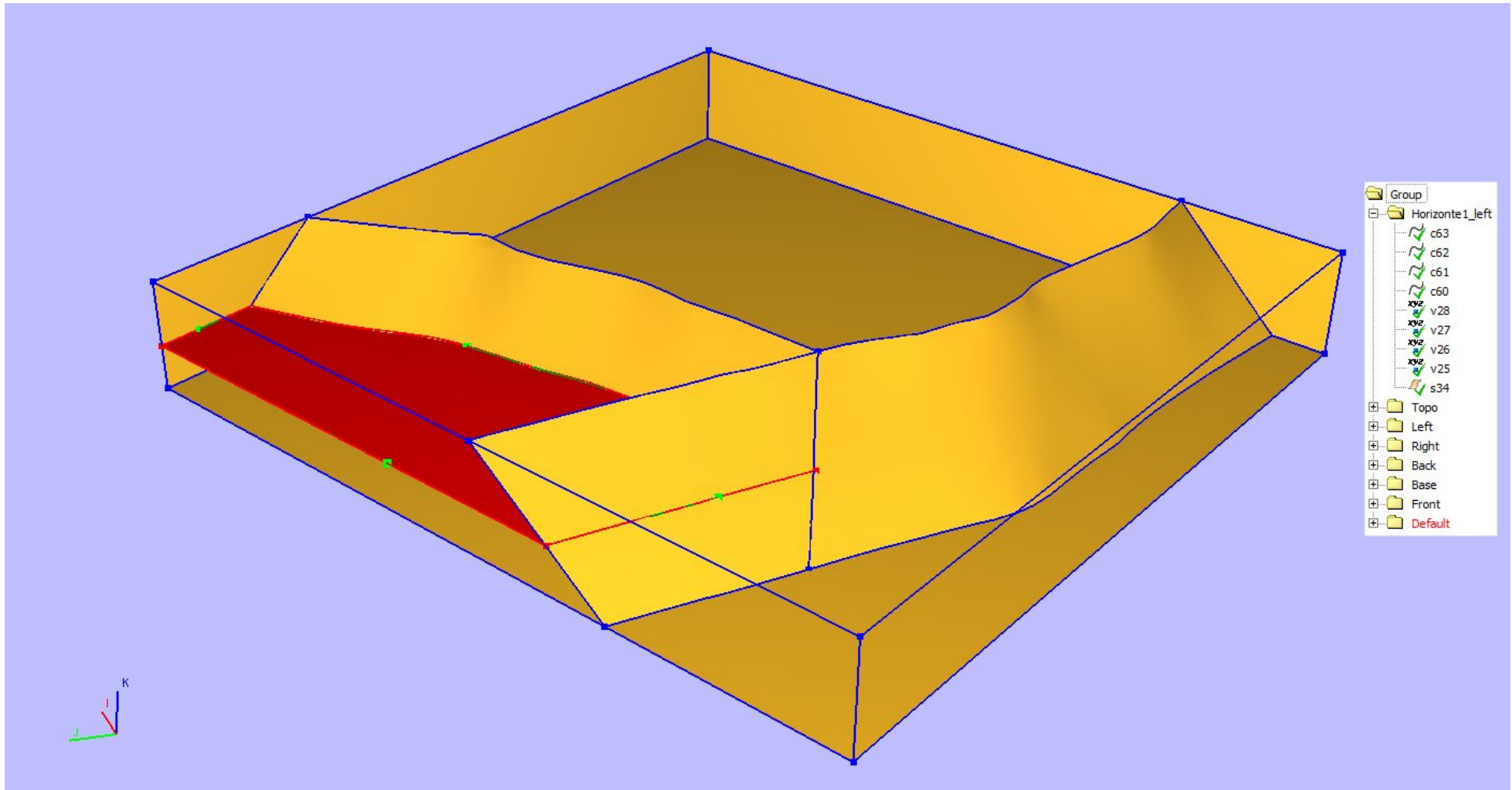

Treatment of other geological horizons

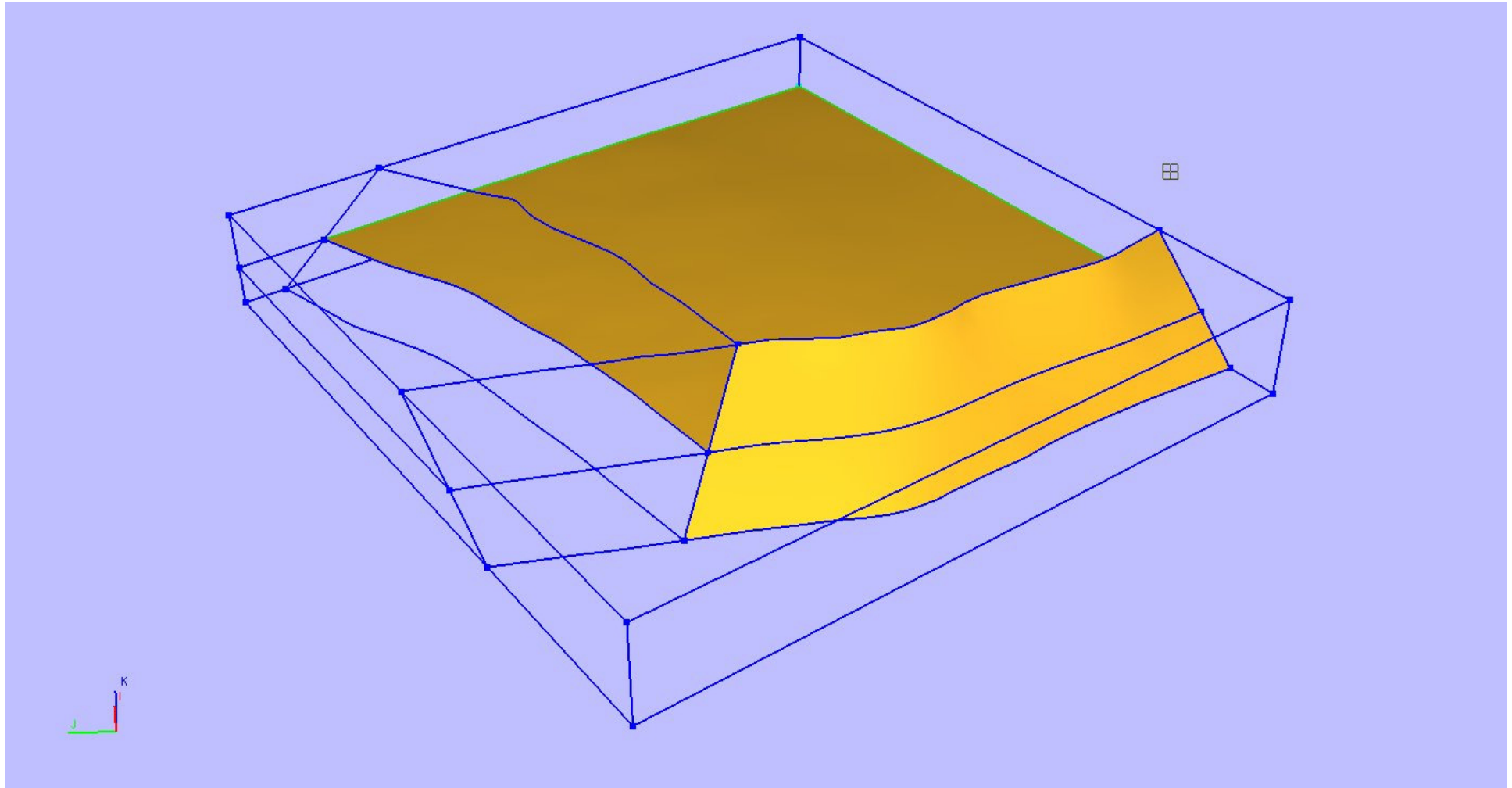

Recovery of original fault geometries

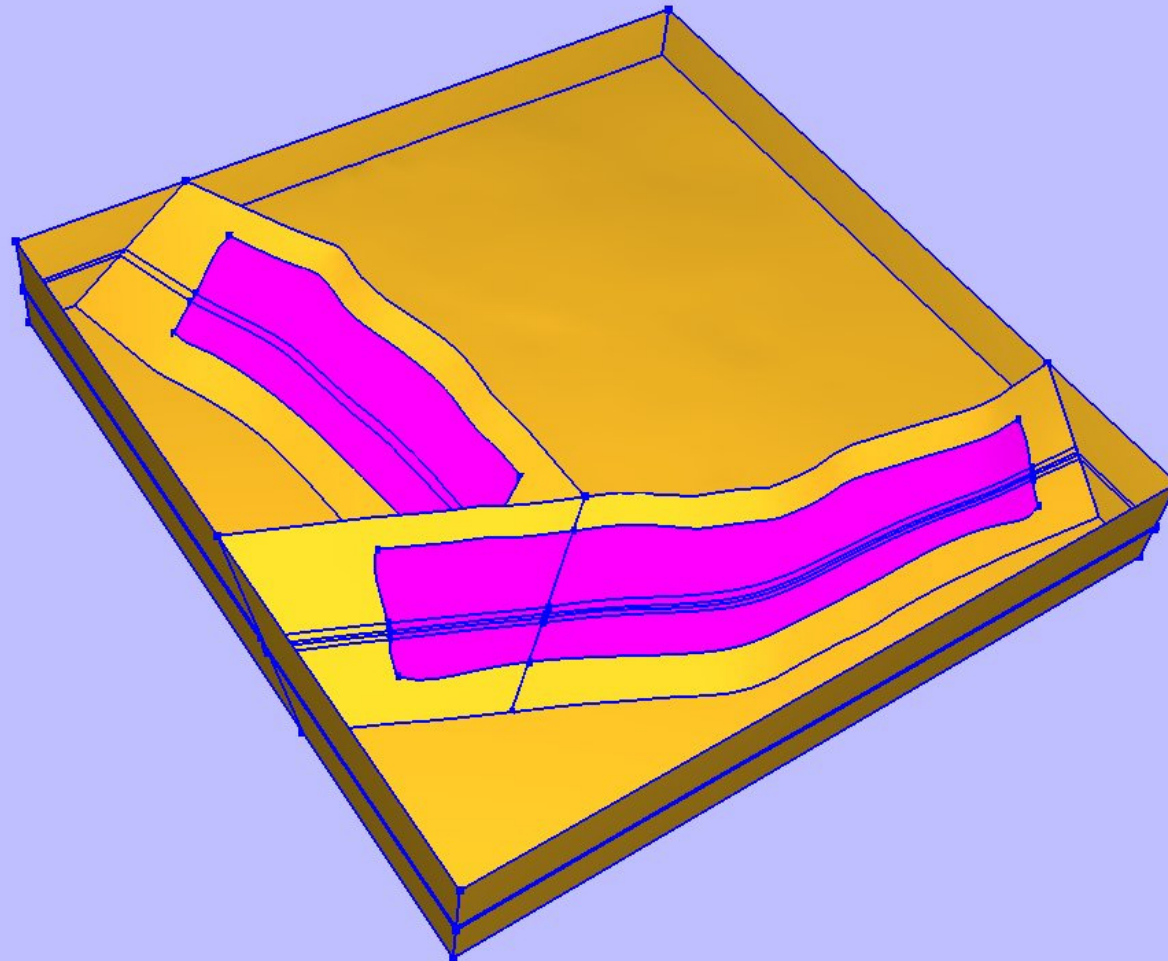

Volume decomposition for mesh generation

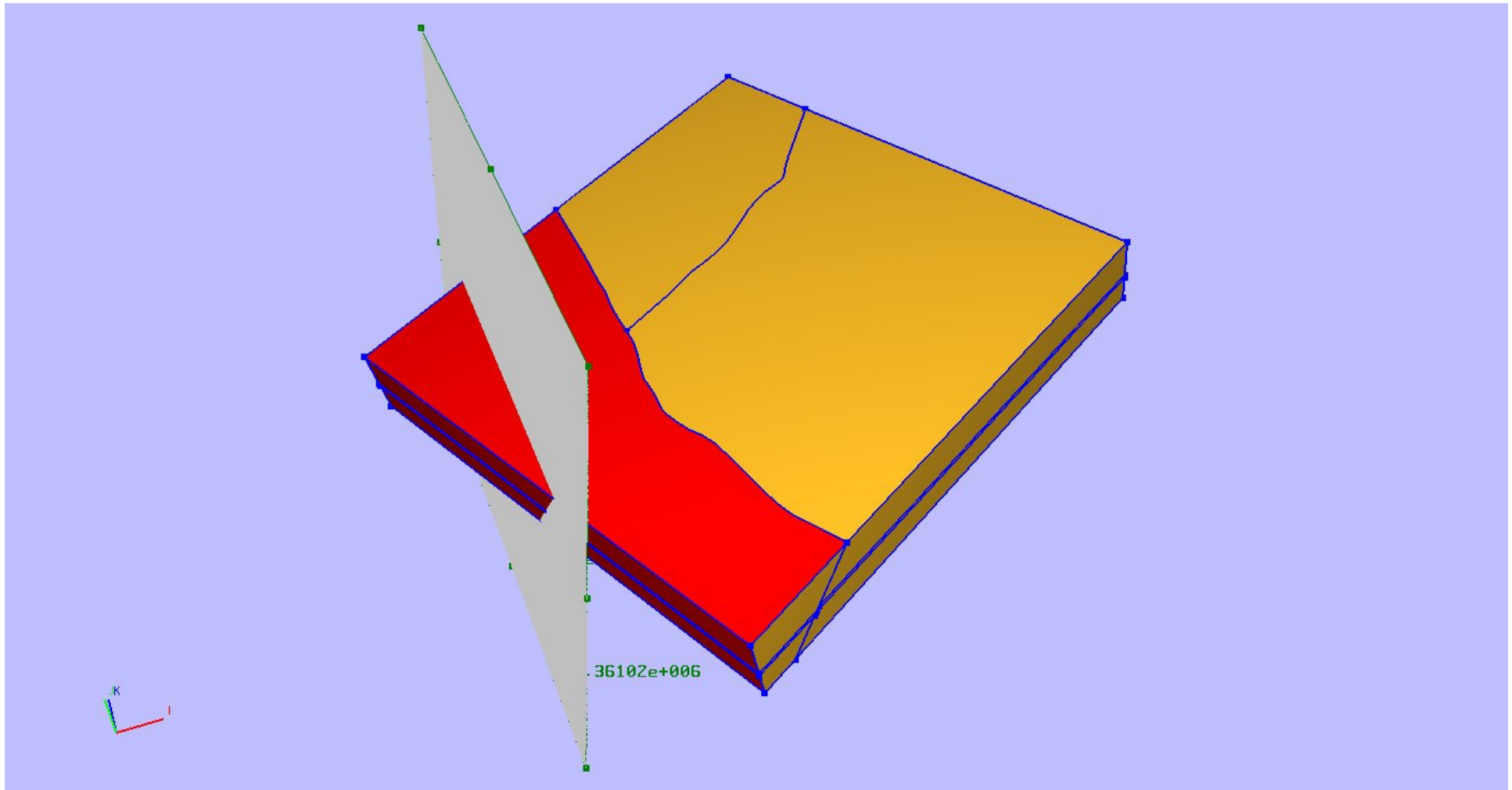

Volume decomposition for mesh generation

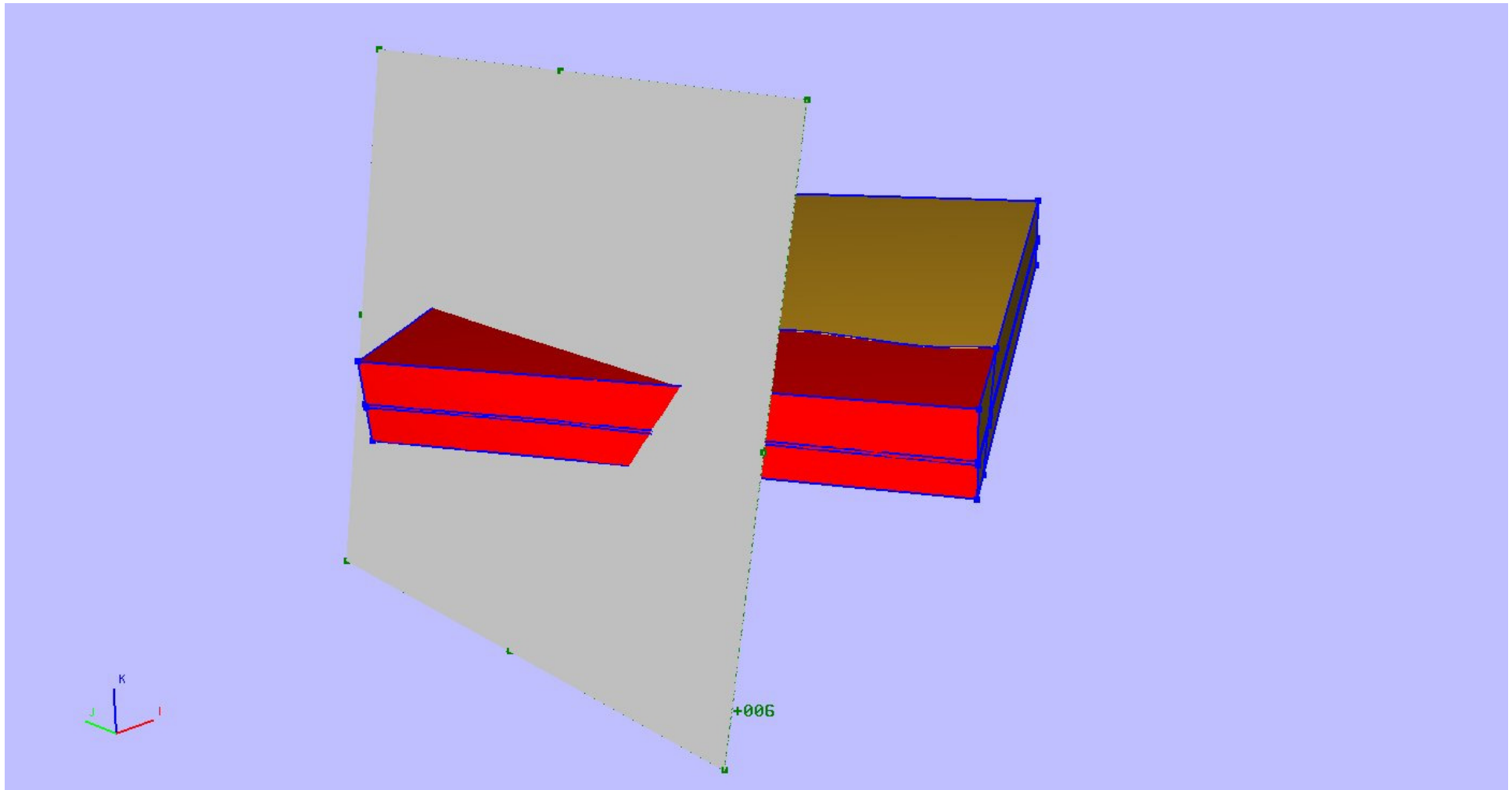

Volume decomposition for mesh generation

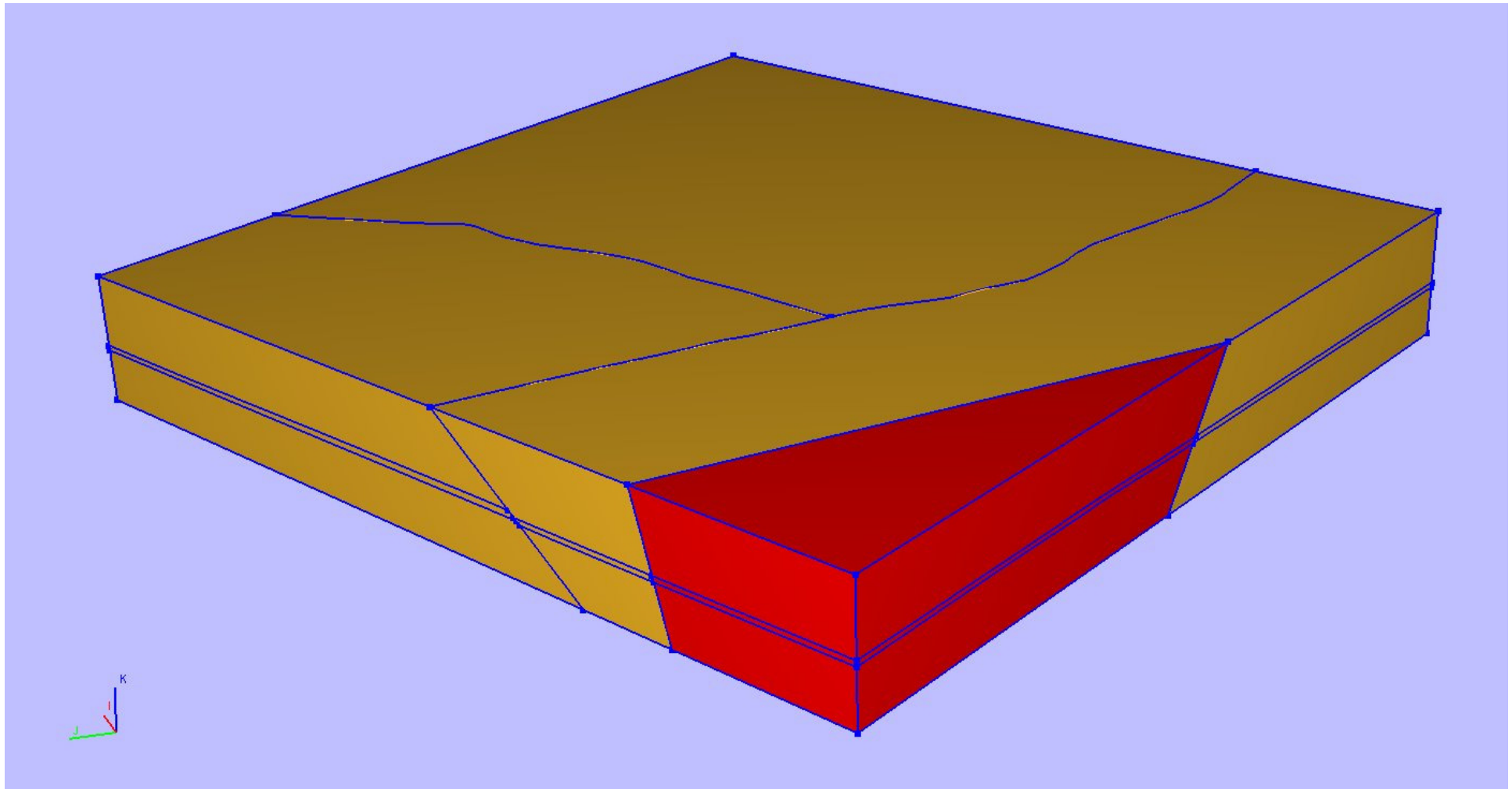

Volume decomposition for mesh generation

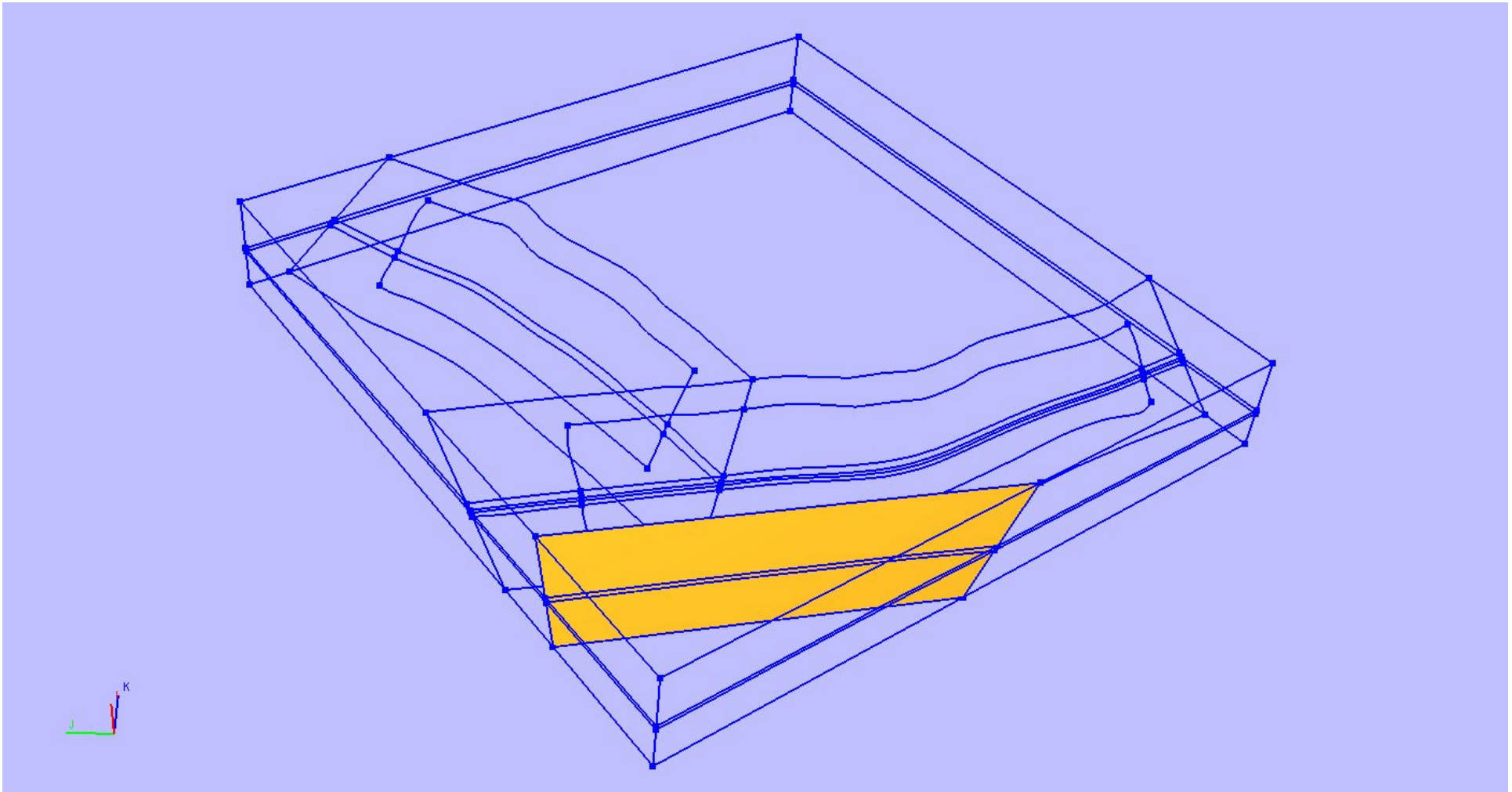

Volume decomposition for mesh generation

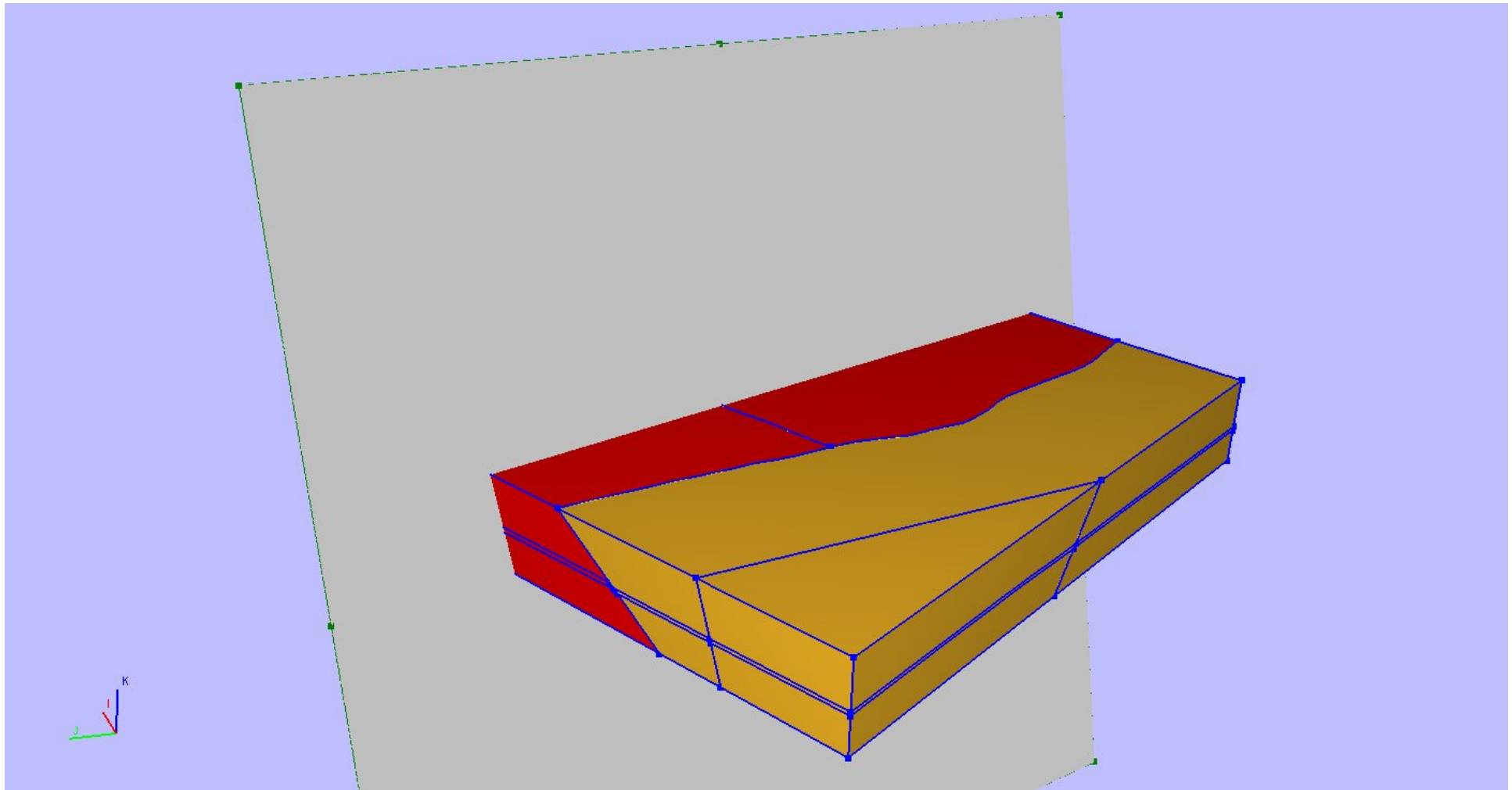

Volume decomposition for mesh generation

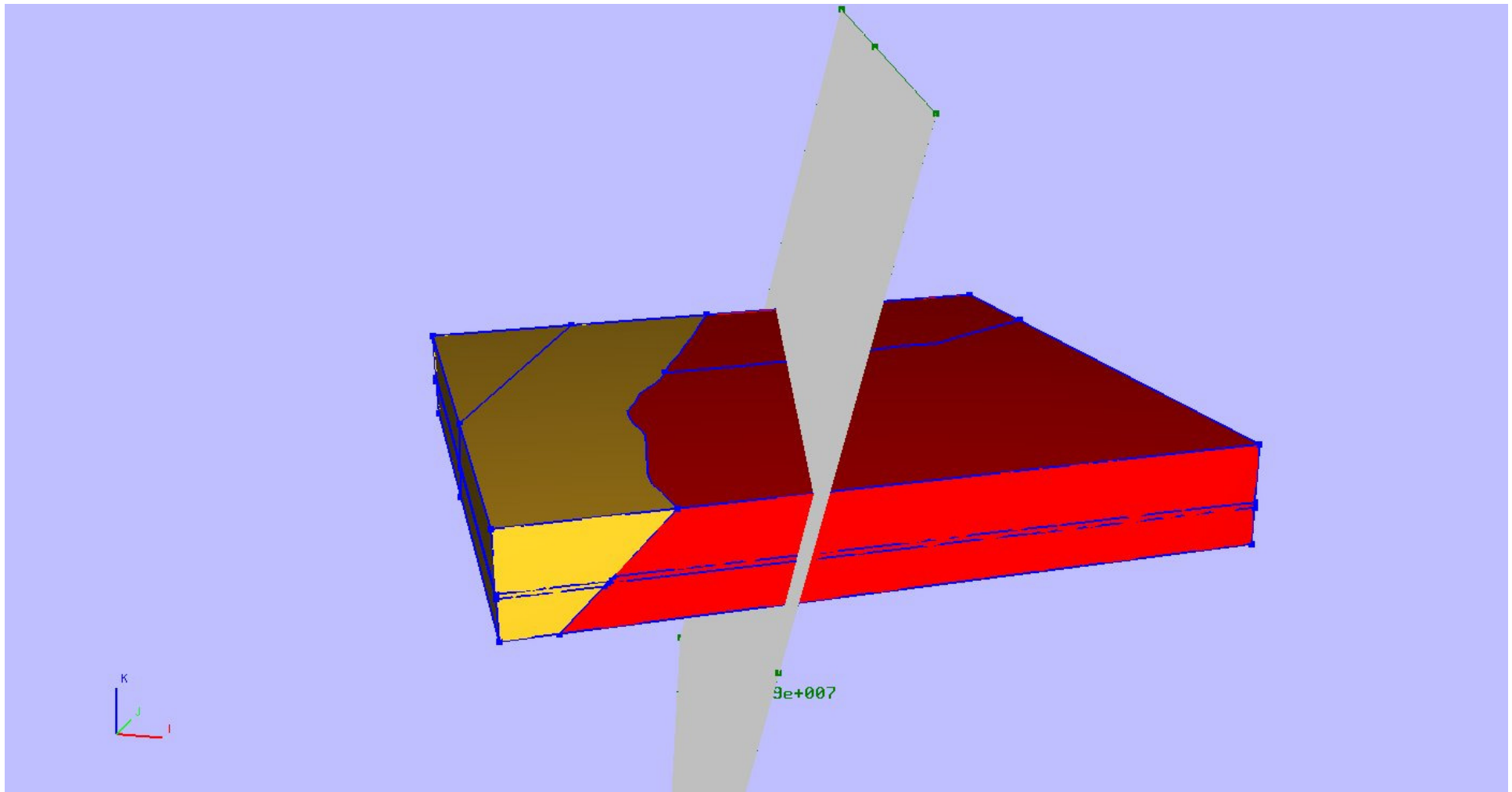

Volume decomposition for mesh generation

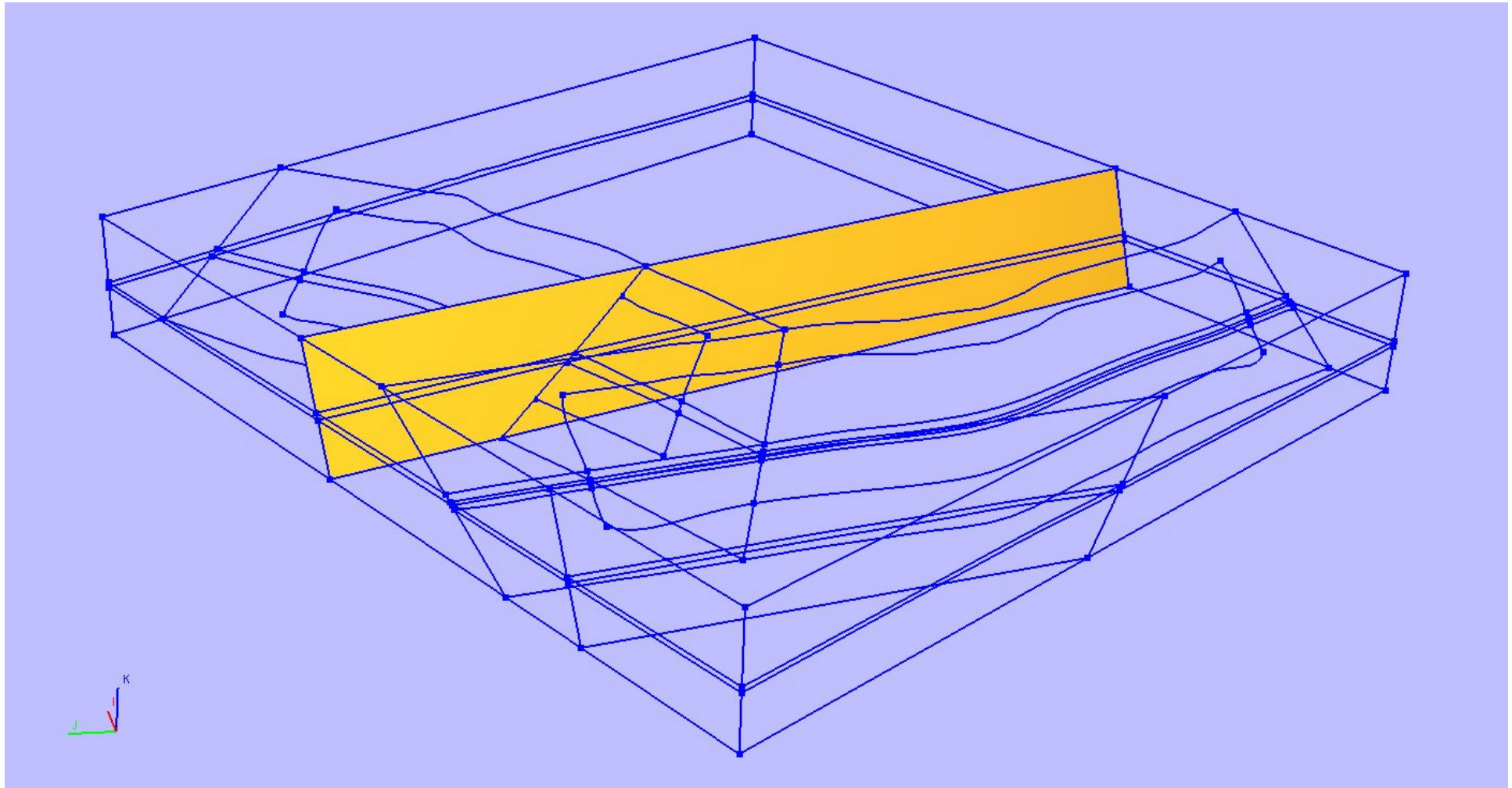

Volume decomposition for mesh generation

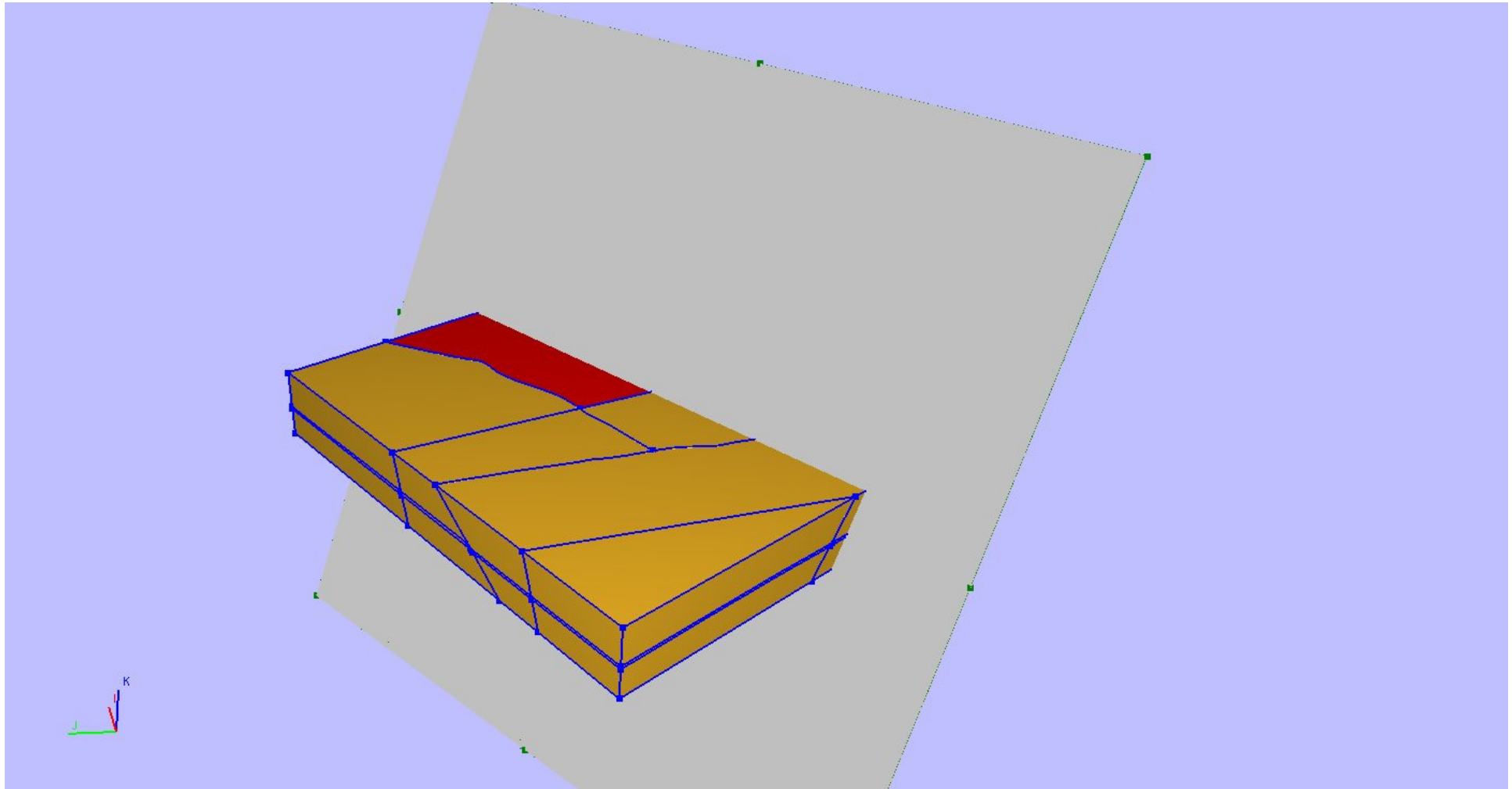

Volume decomposition for mesh generation

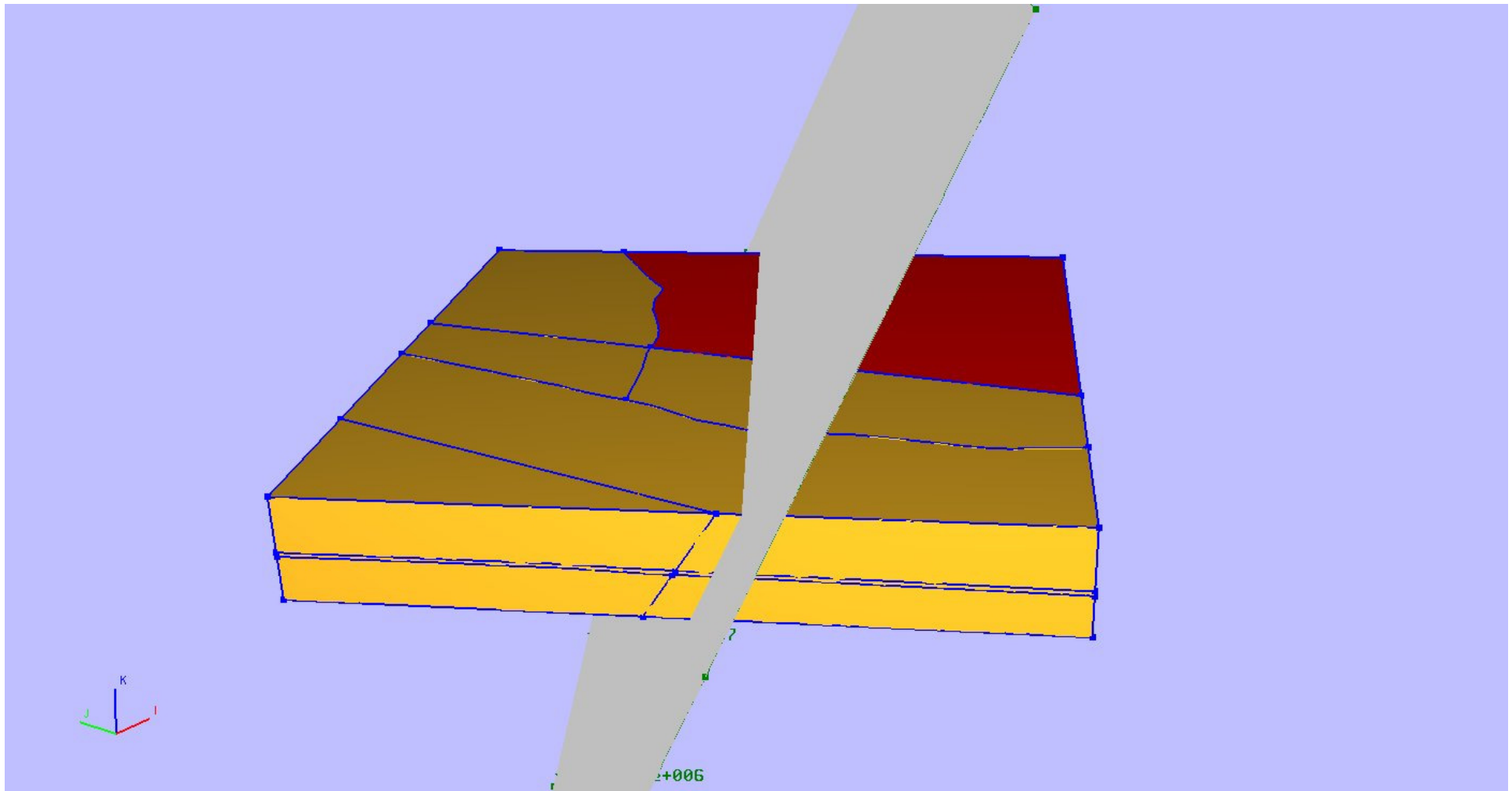

Volume decomposition for mesh generation

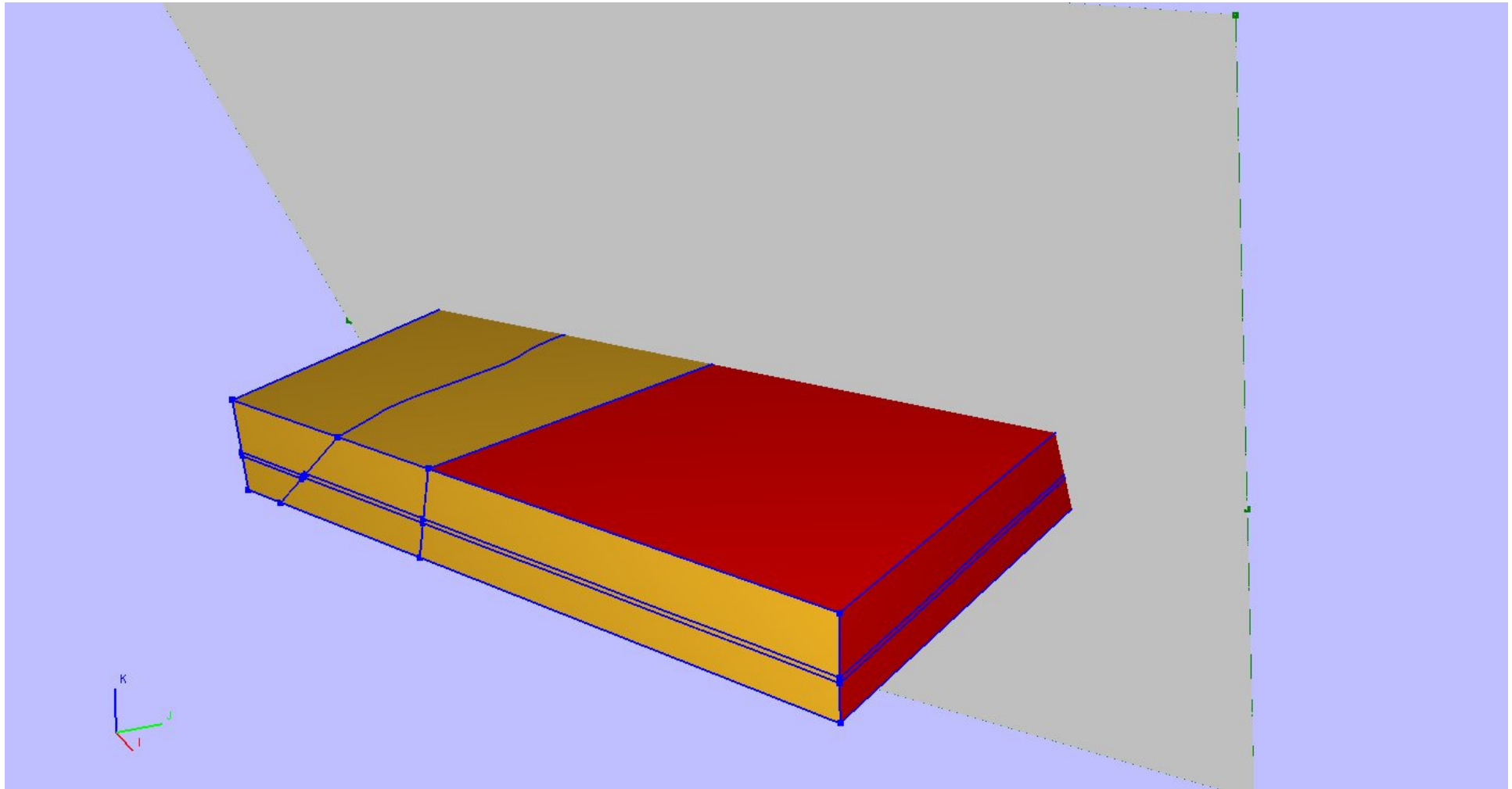

Volume decomposition for mesh generation

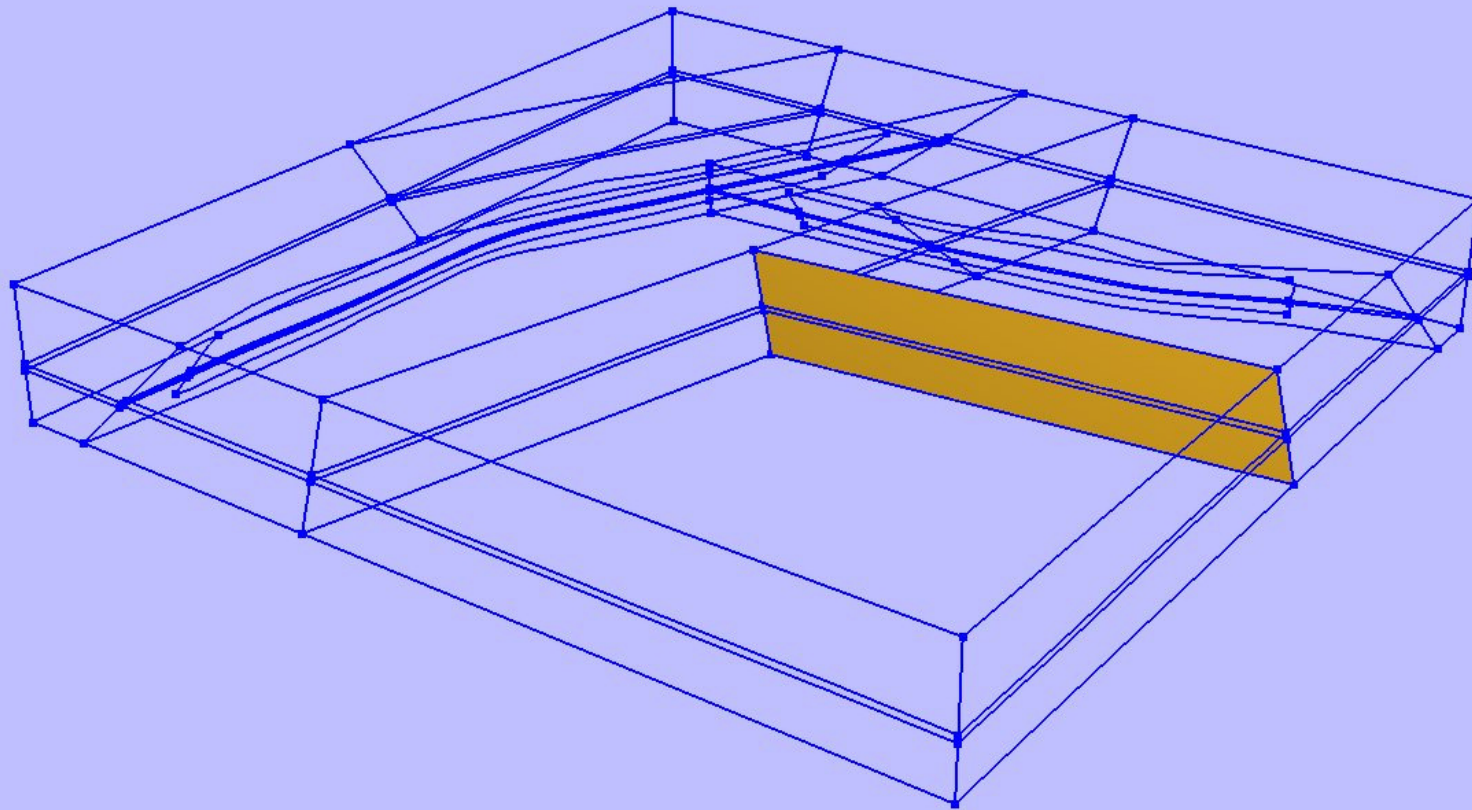

Curve subdivision

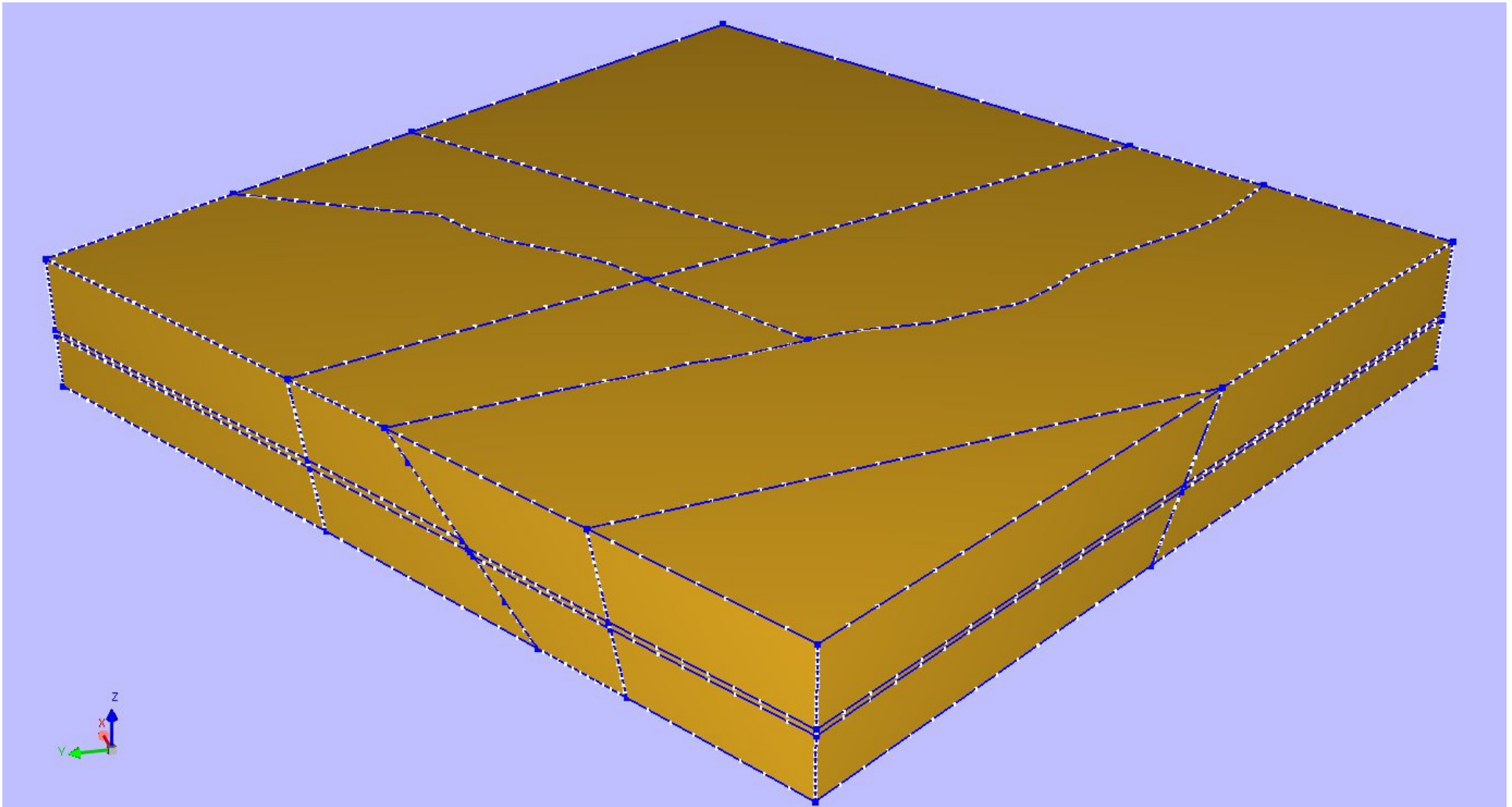

Surface mesh generation

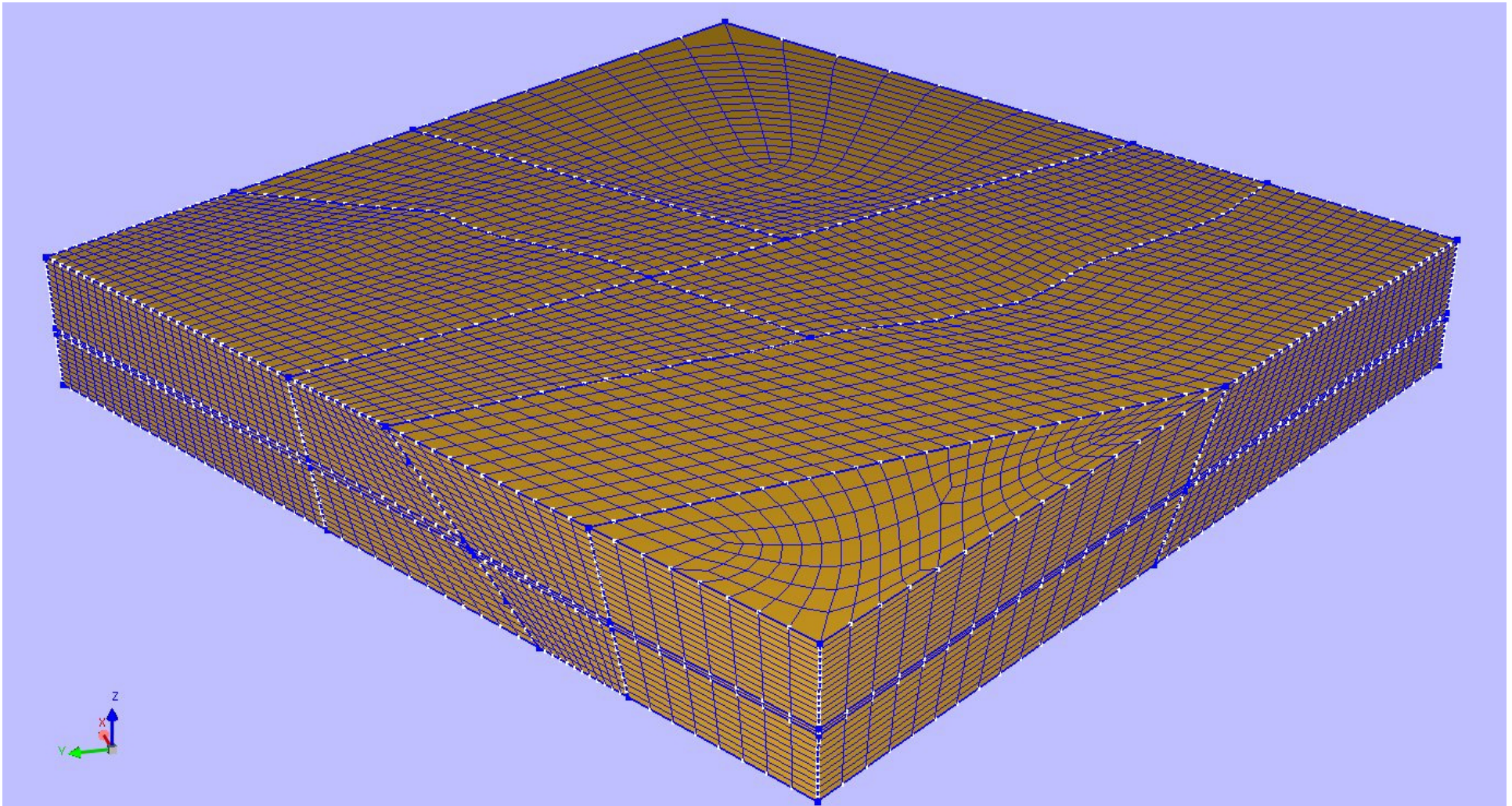

Surface mesh generation

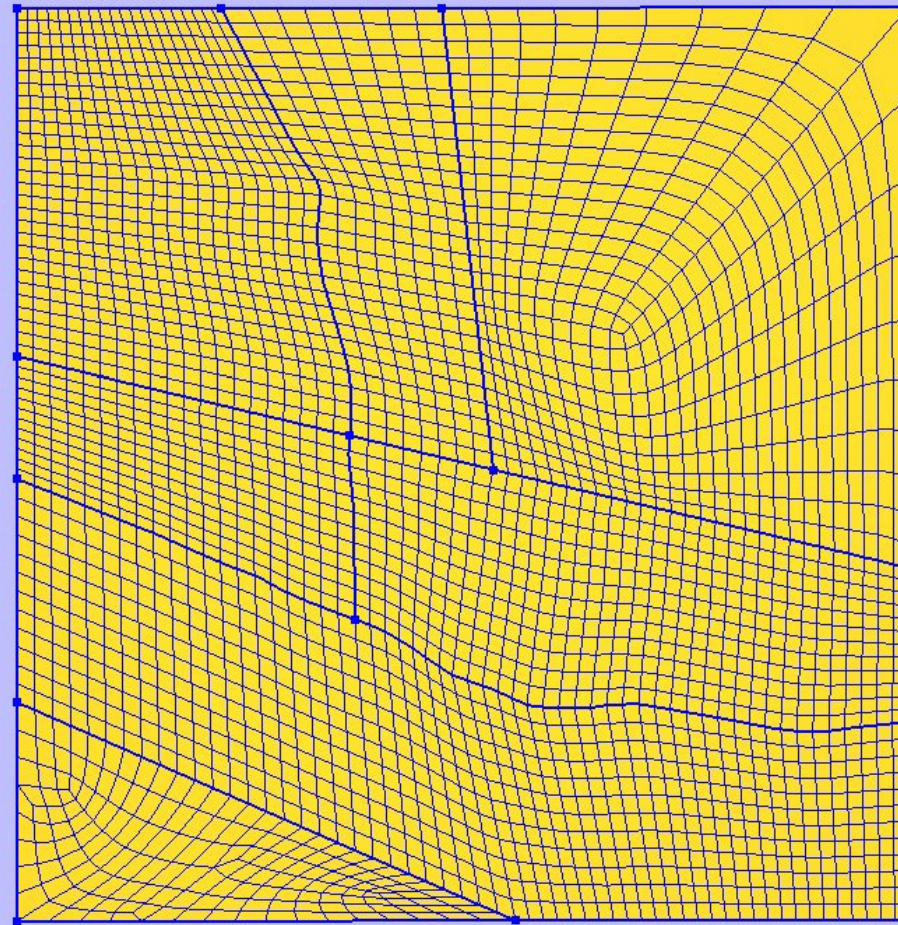

Surface mesh generation

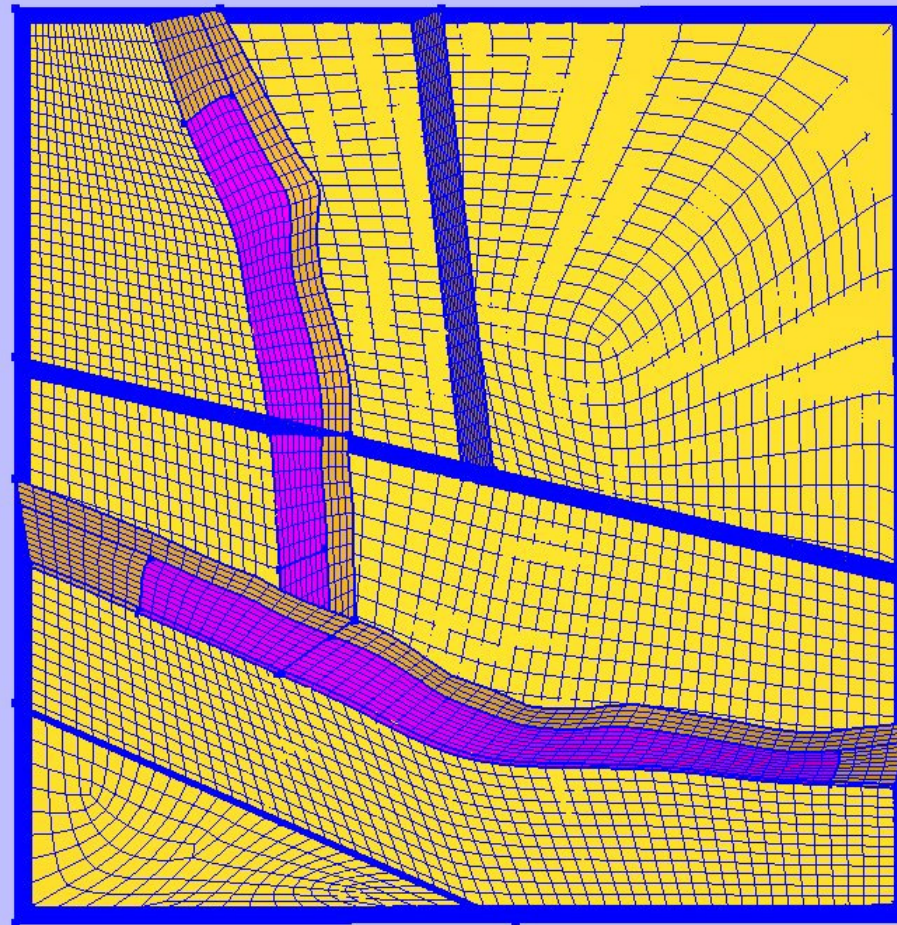

Surface mesh generation

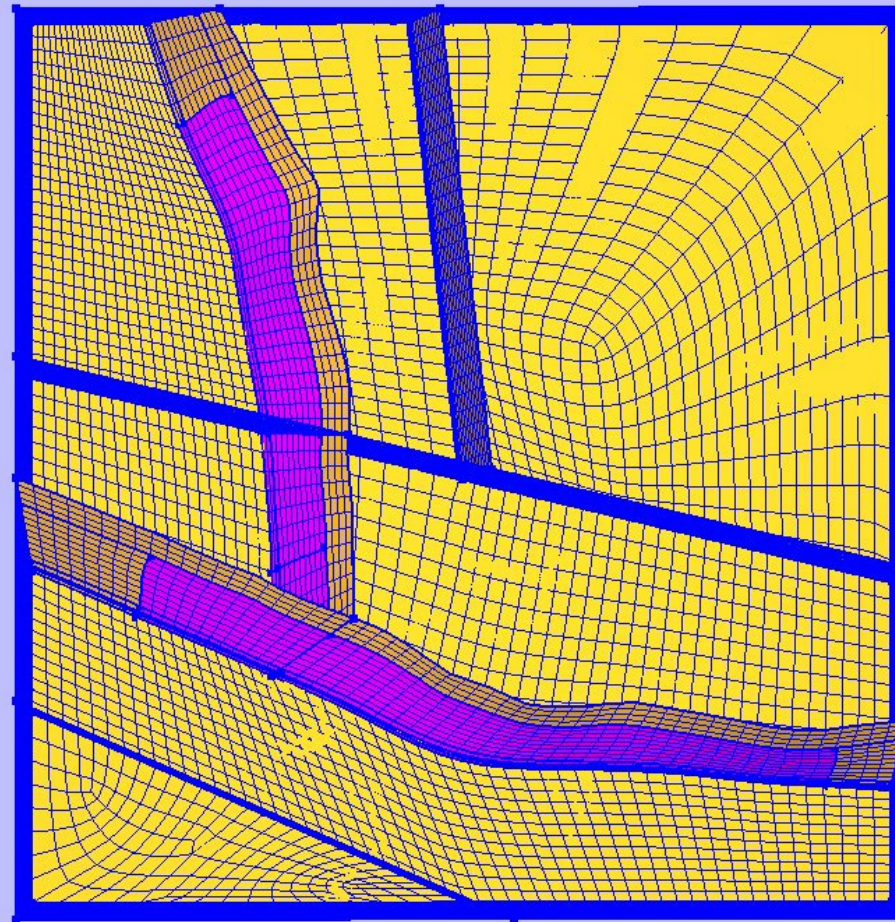

Surface mesh generation

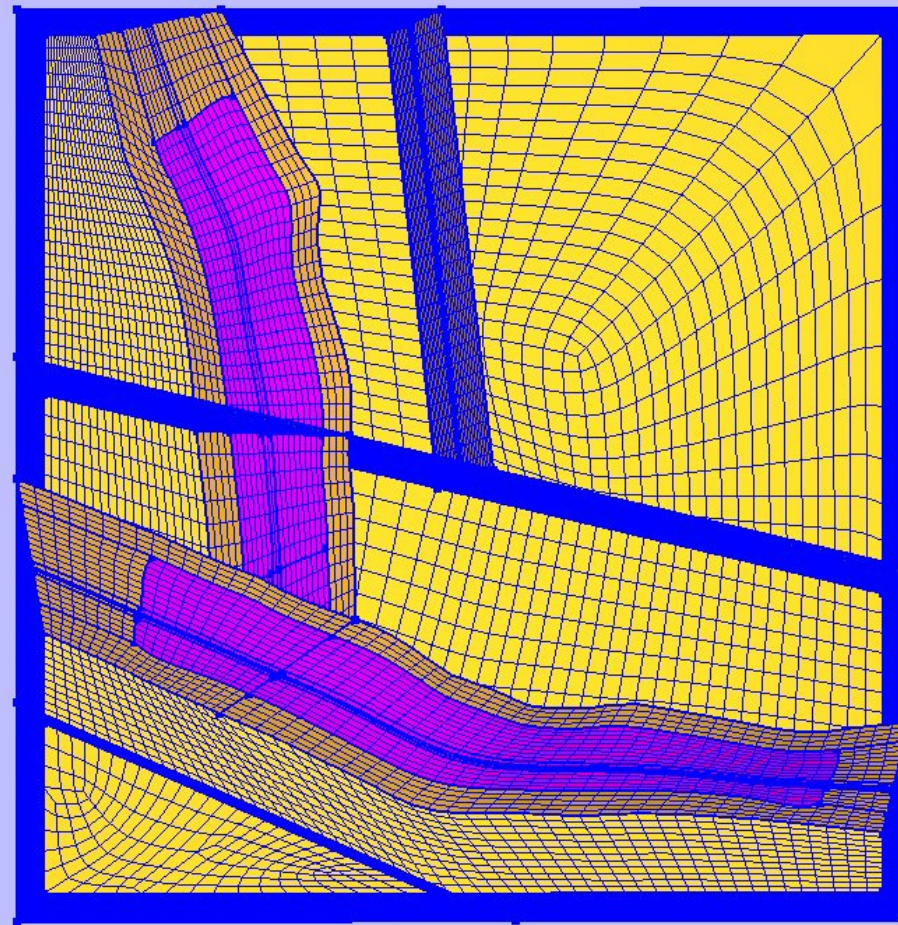

Surface mesh generation

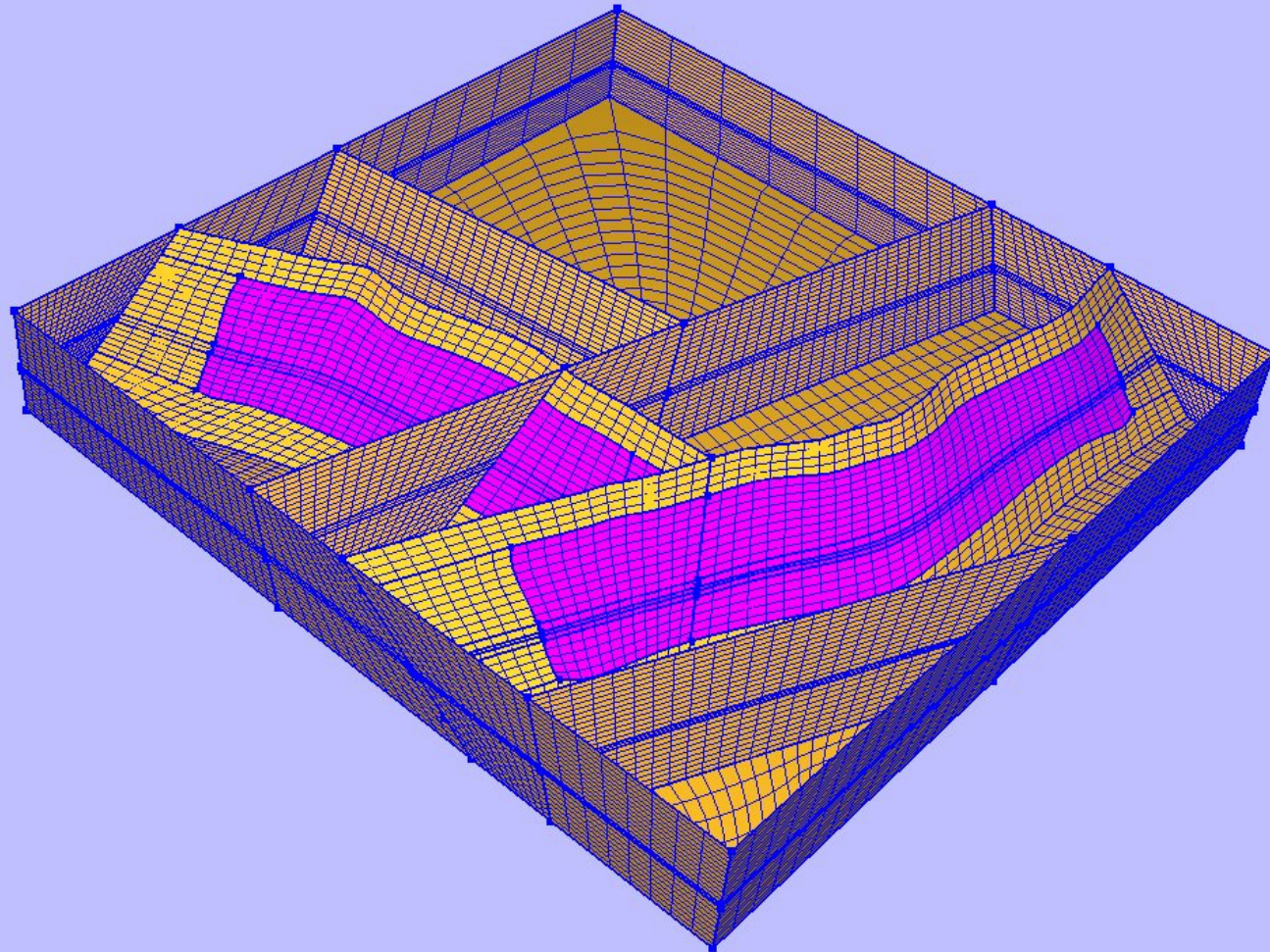

Surface mesh generation

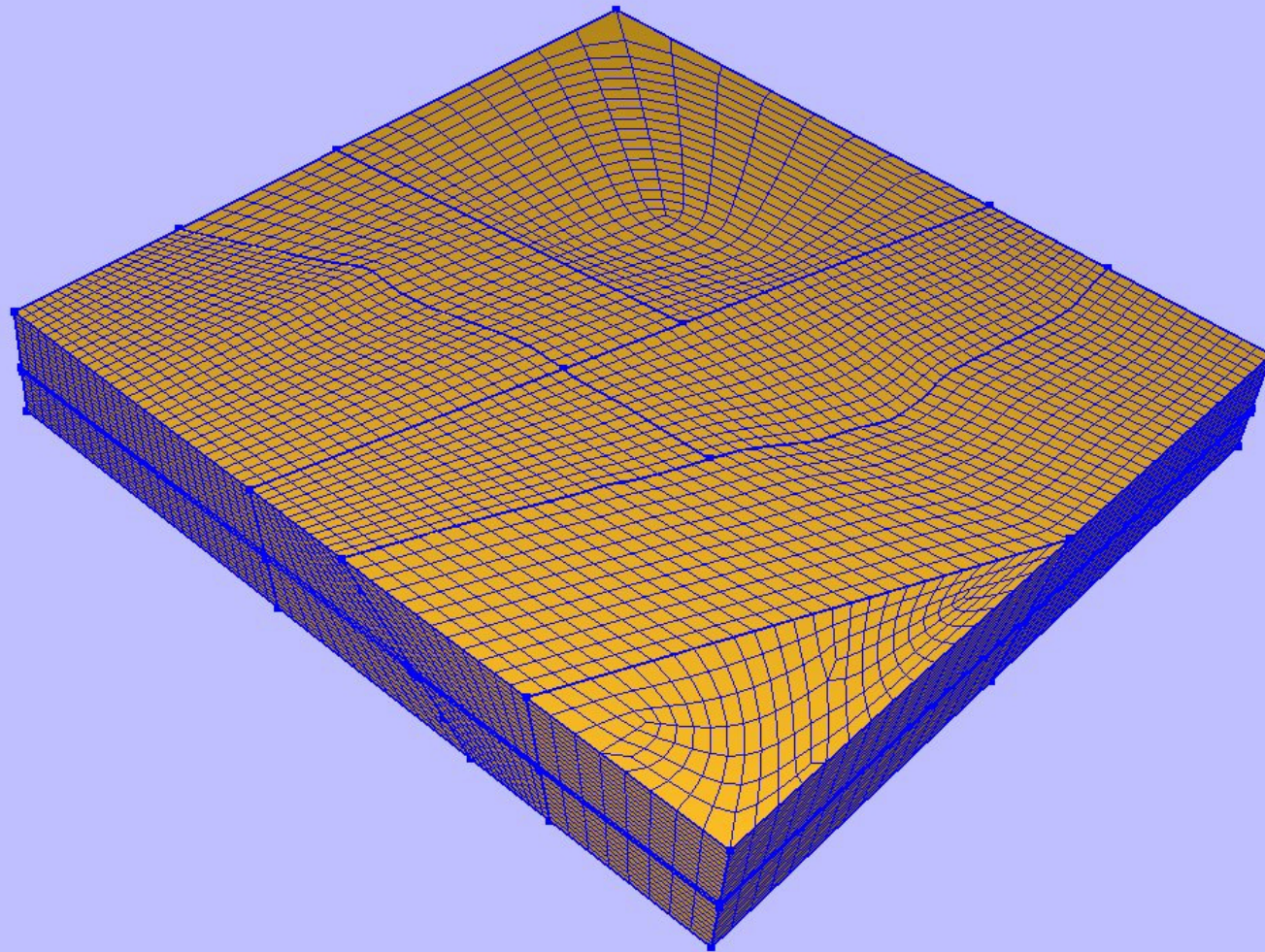

Automatic volume recognition

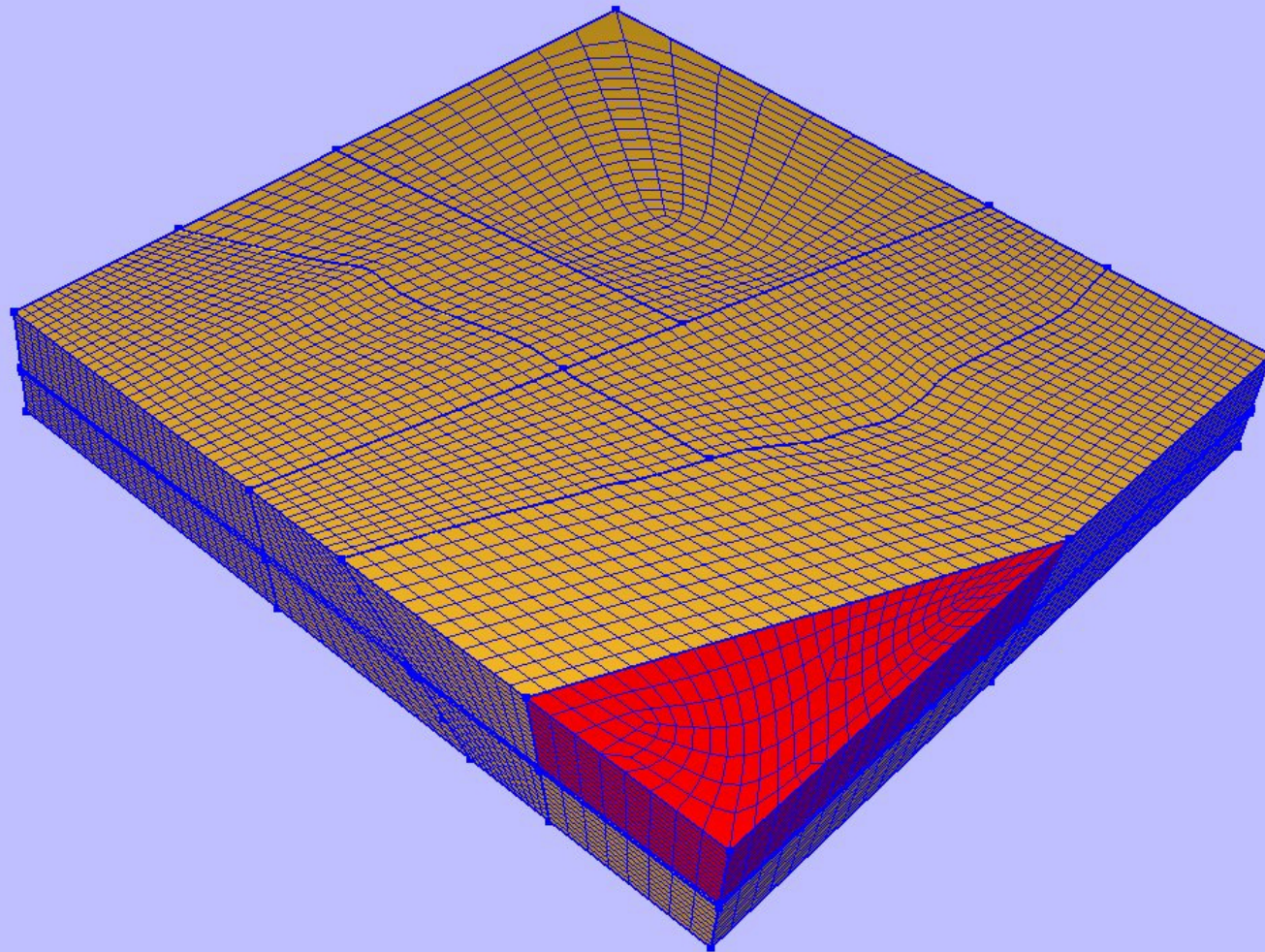

Automatic volume recognition

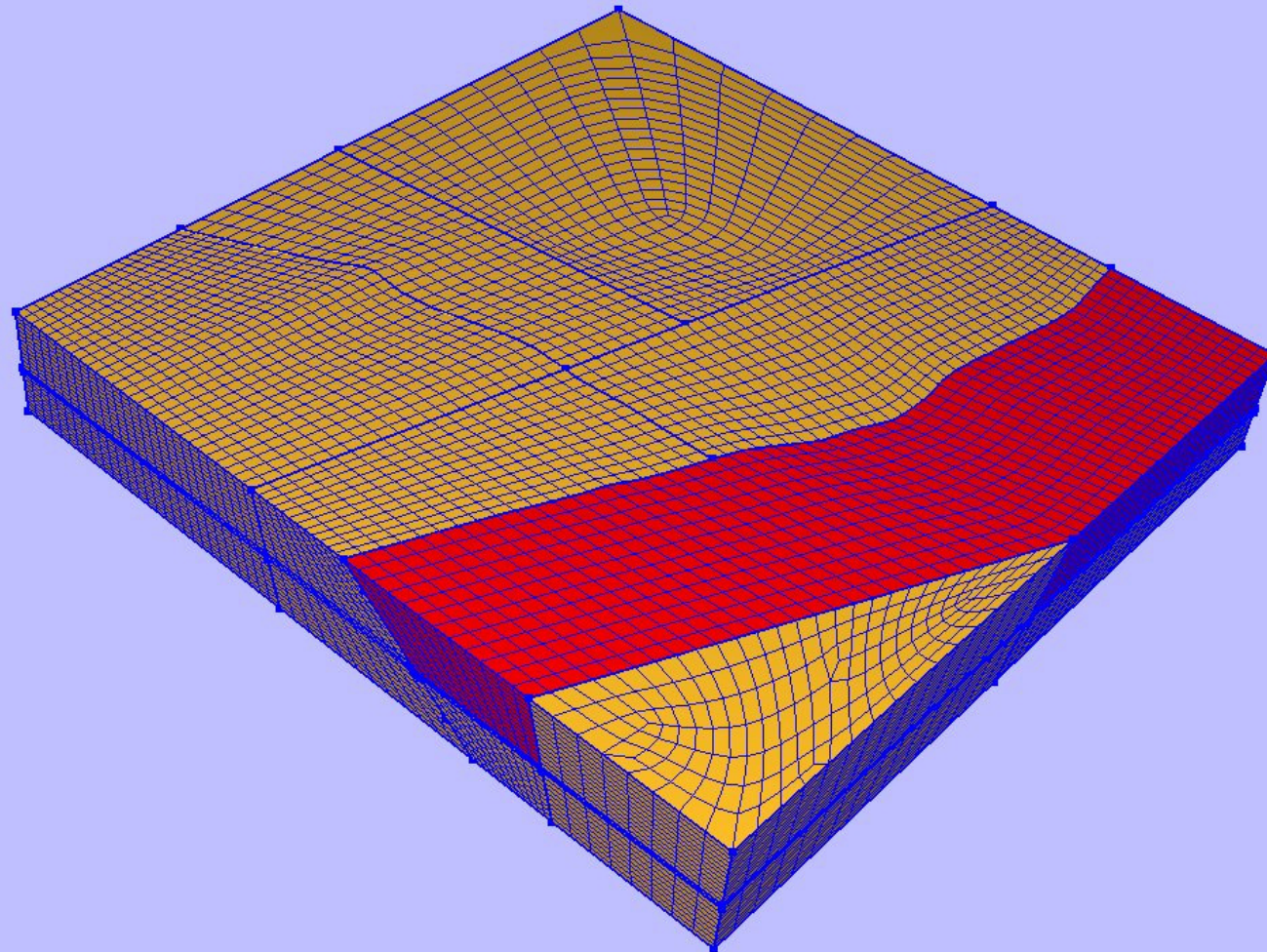

Automatic volume recognition

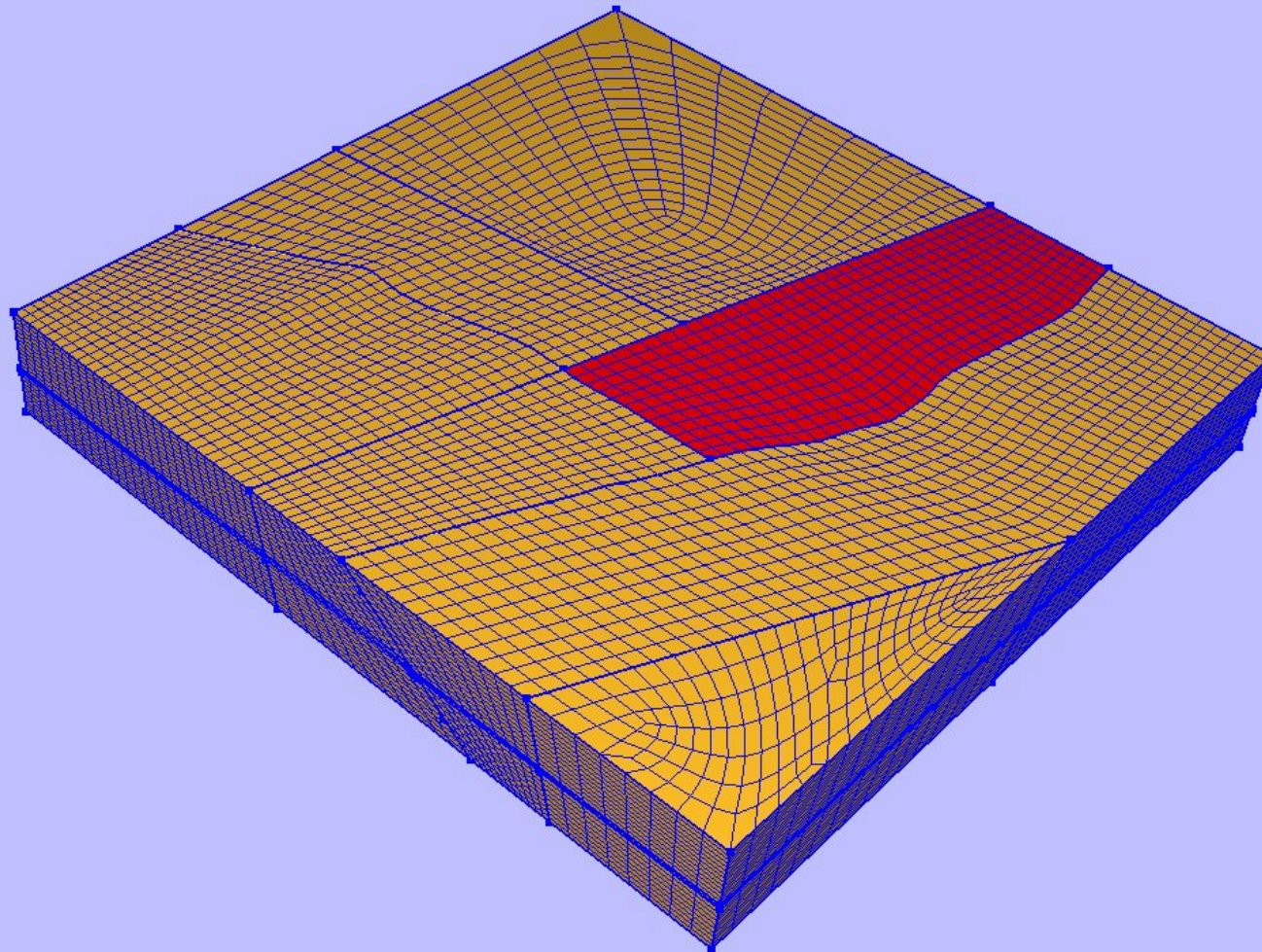

Automatic volume recognition

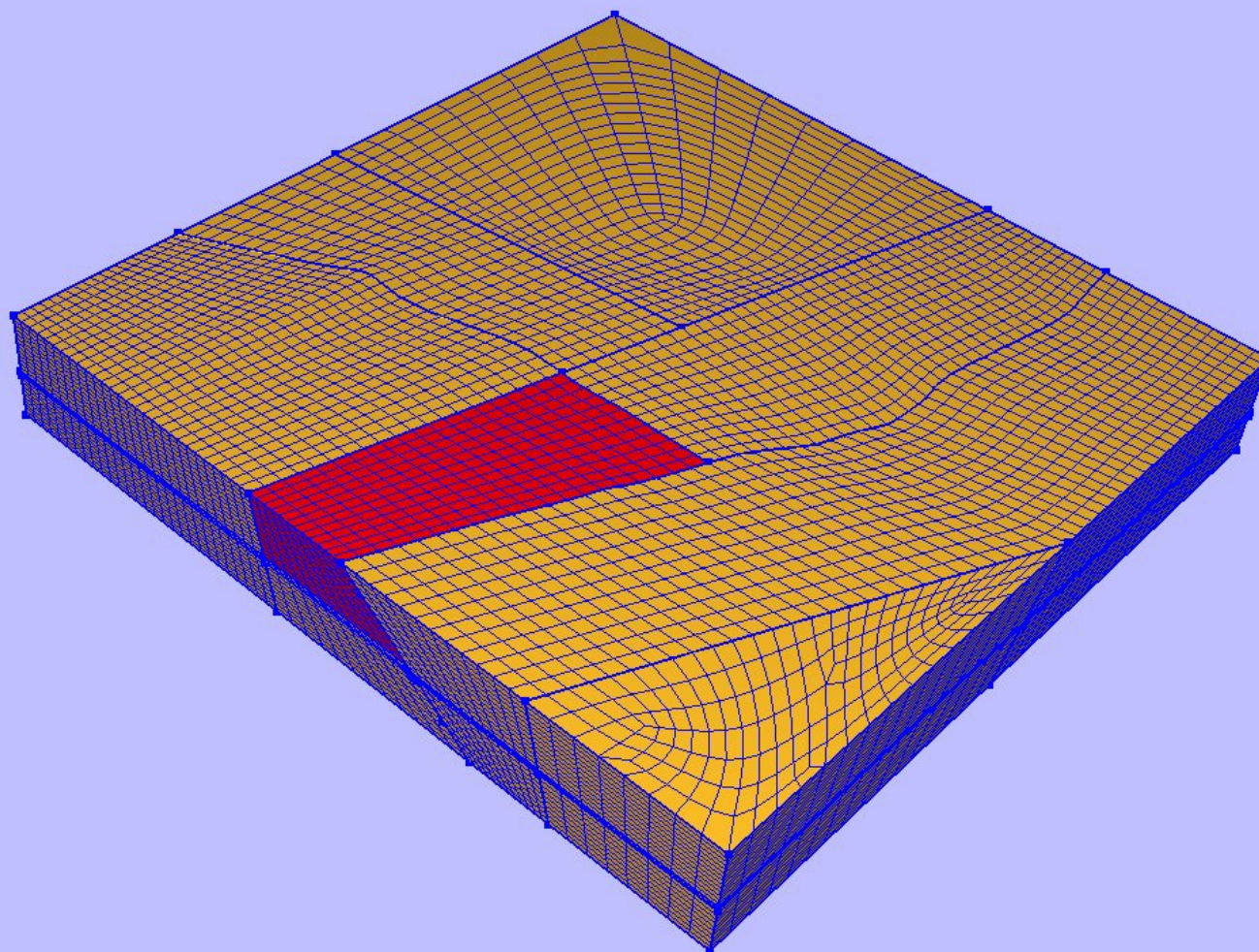

Automatic volume recognition

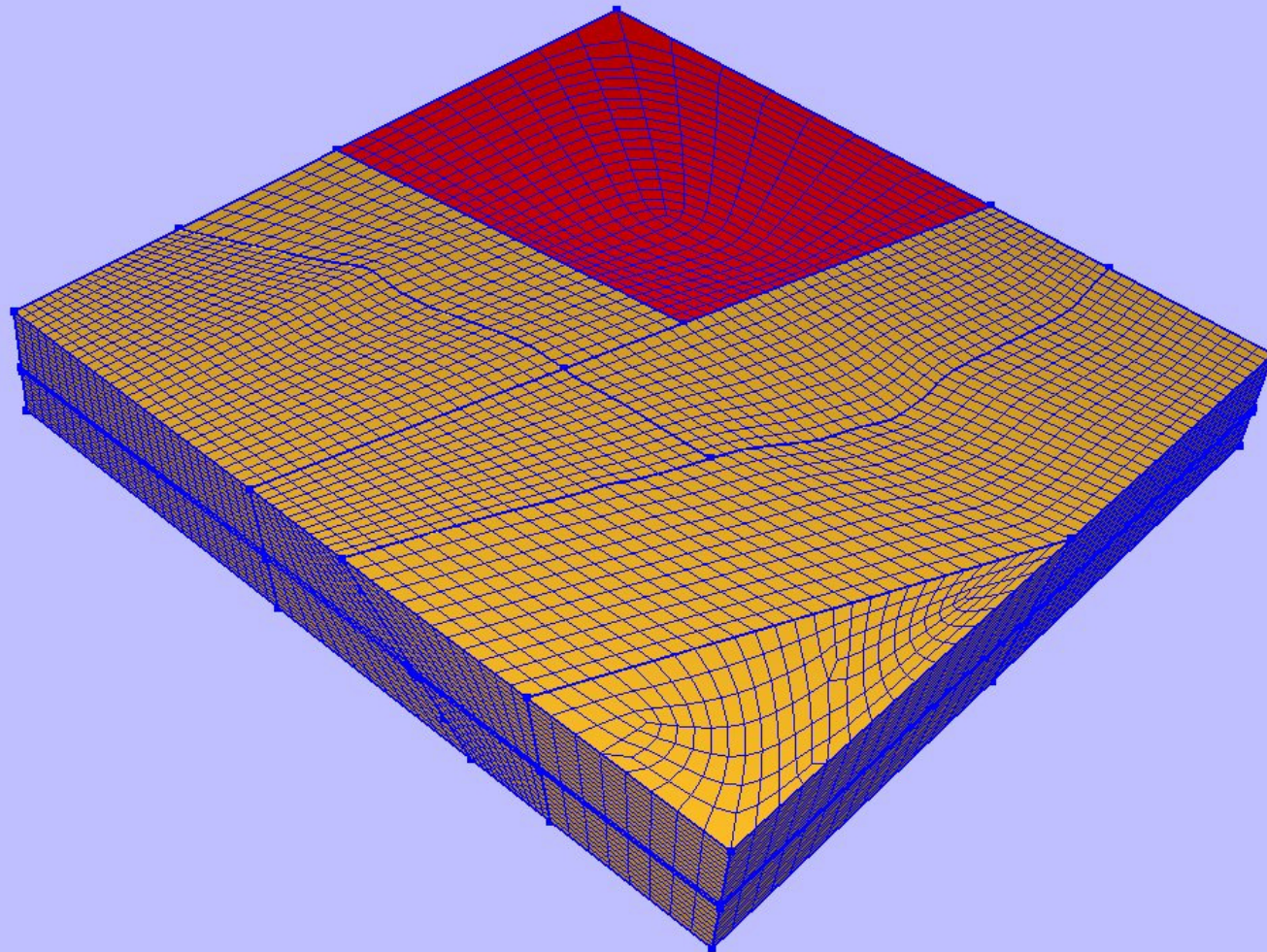

Automatic volume recognition

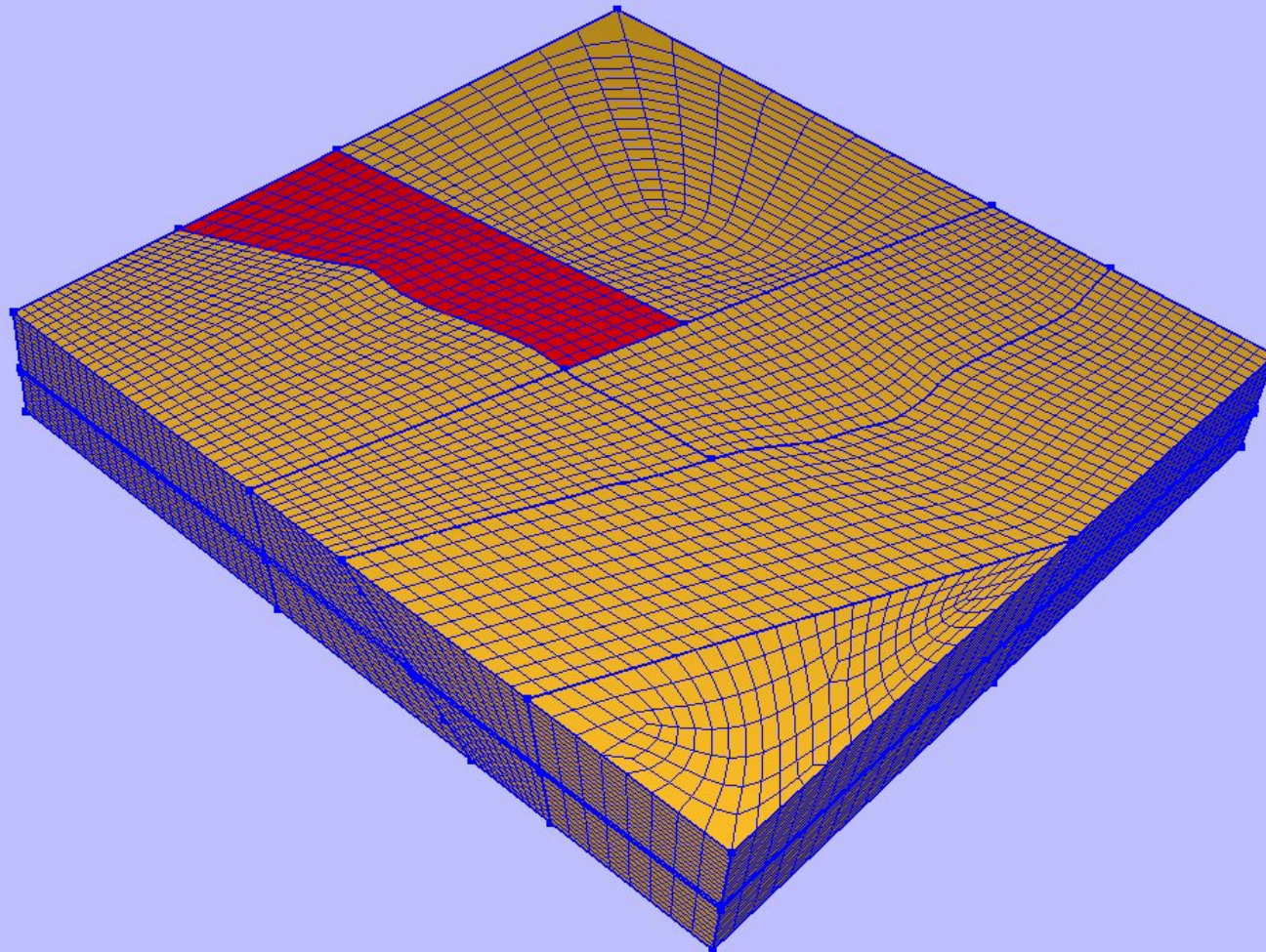

Automatic volume recognition

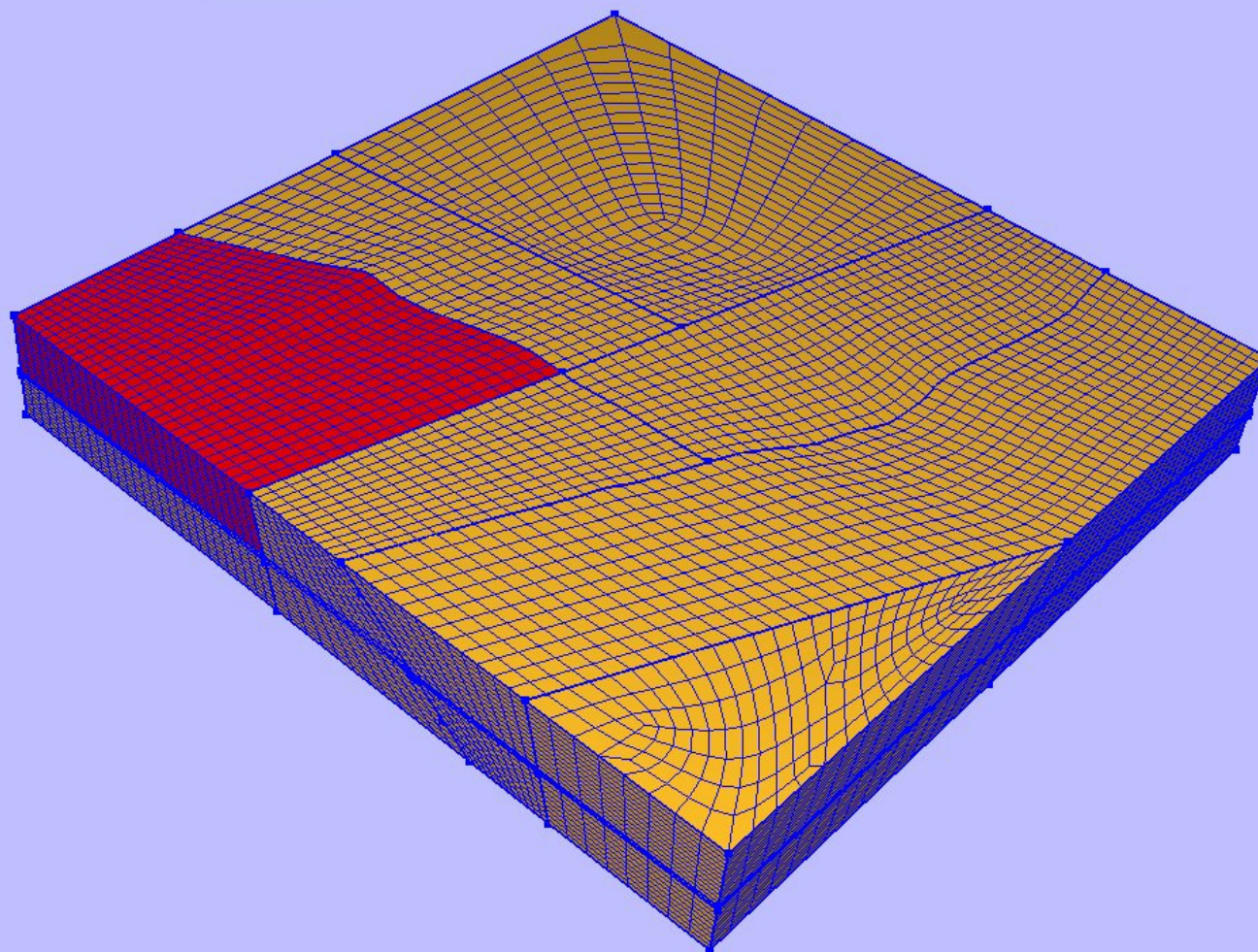

3D mapping mesh generation

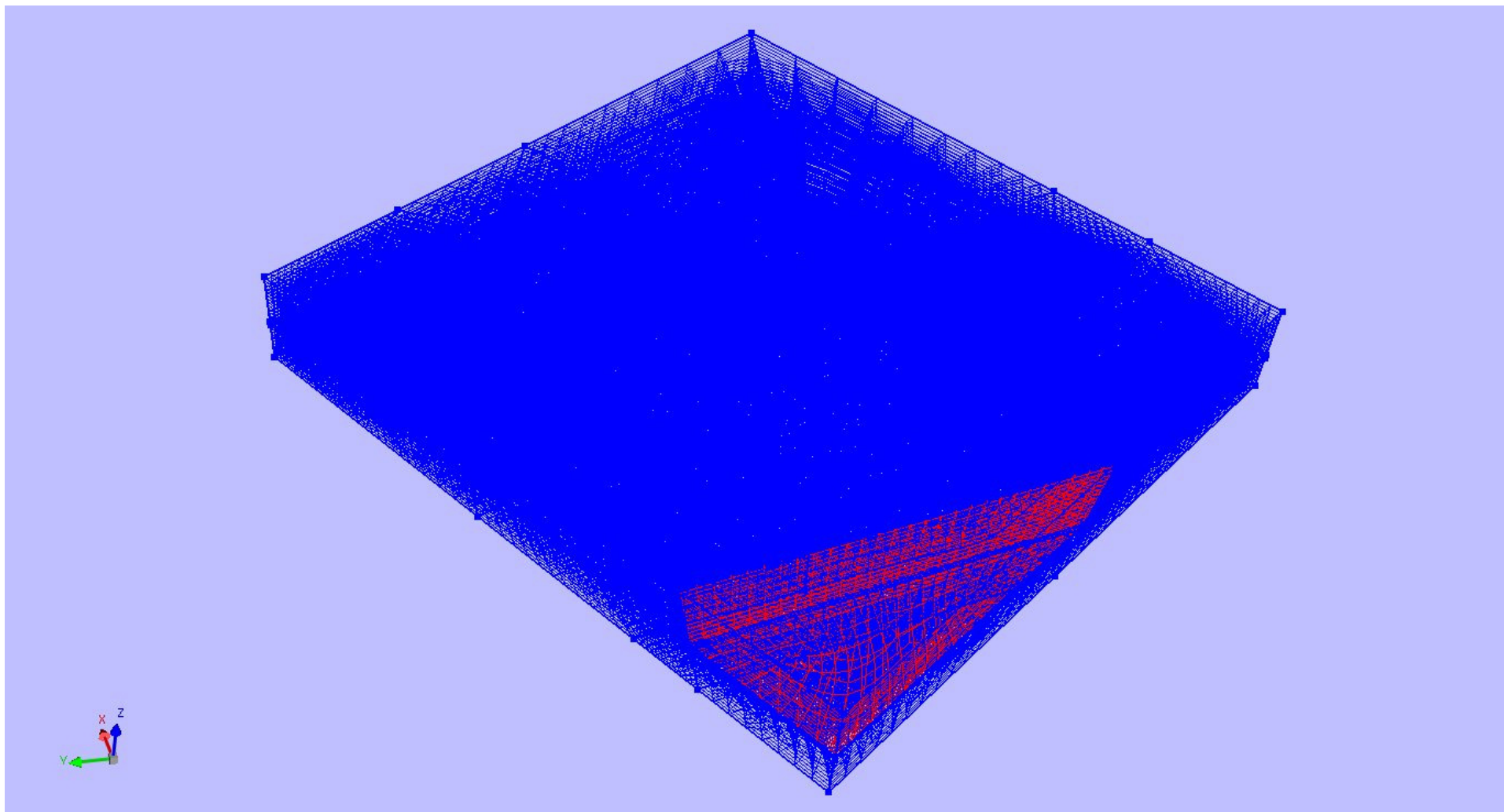

3D mapping mesh generation

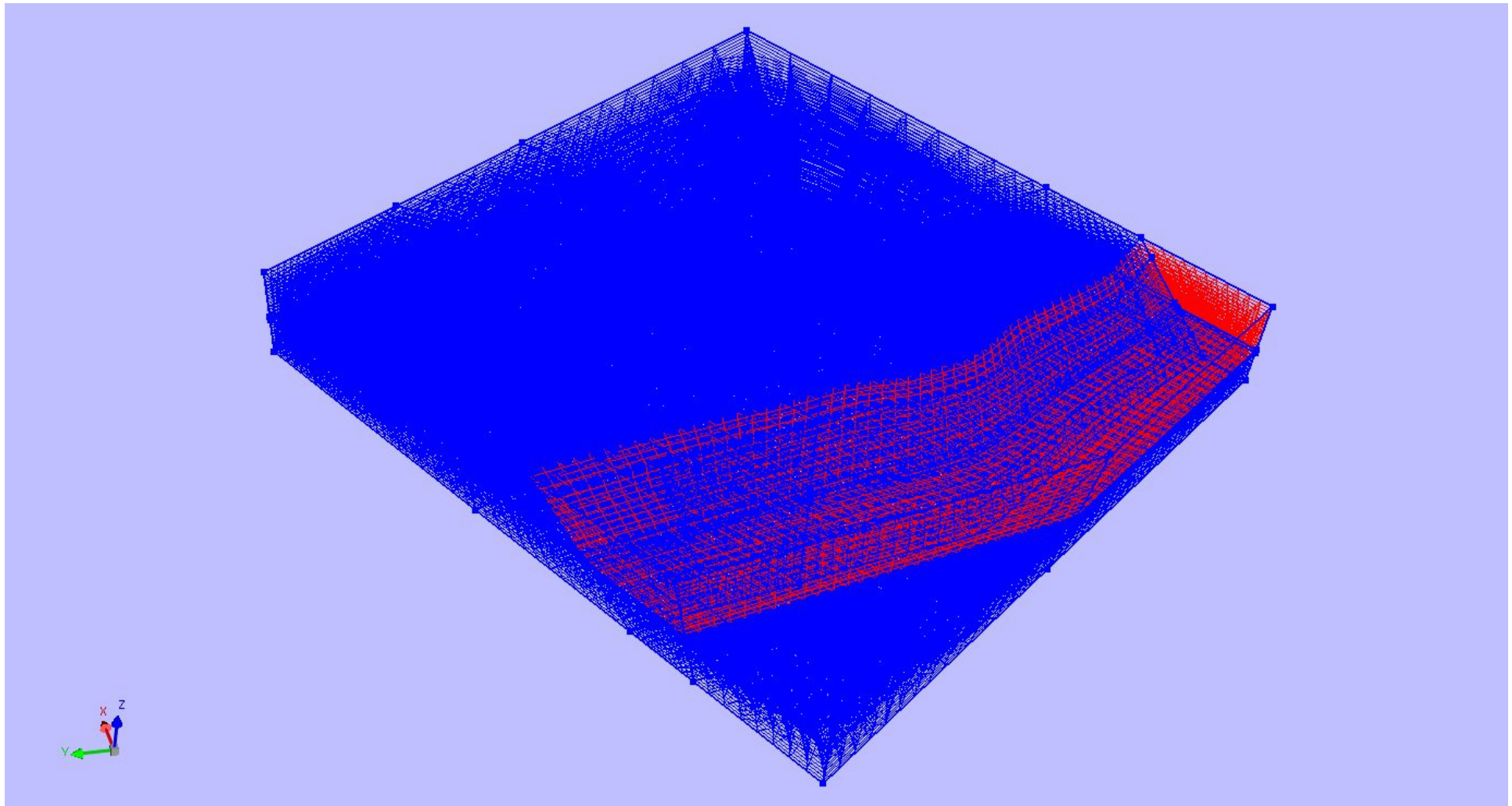

3D mapping mesh generation

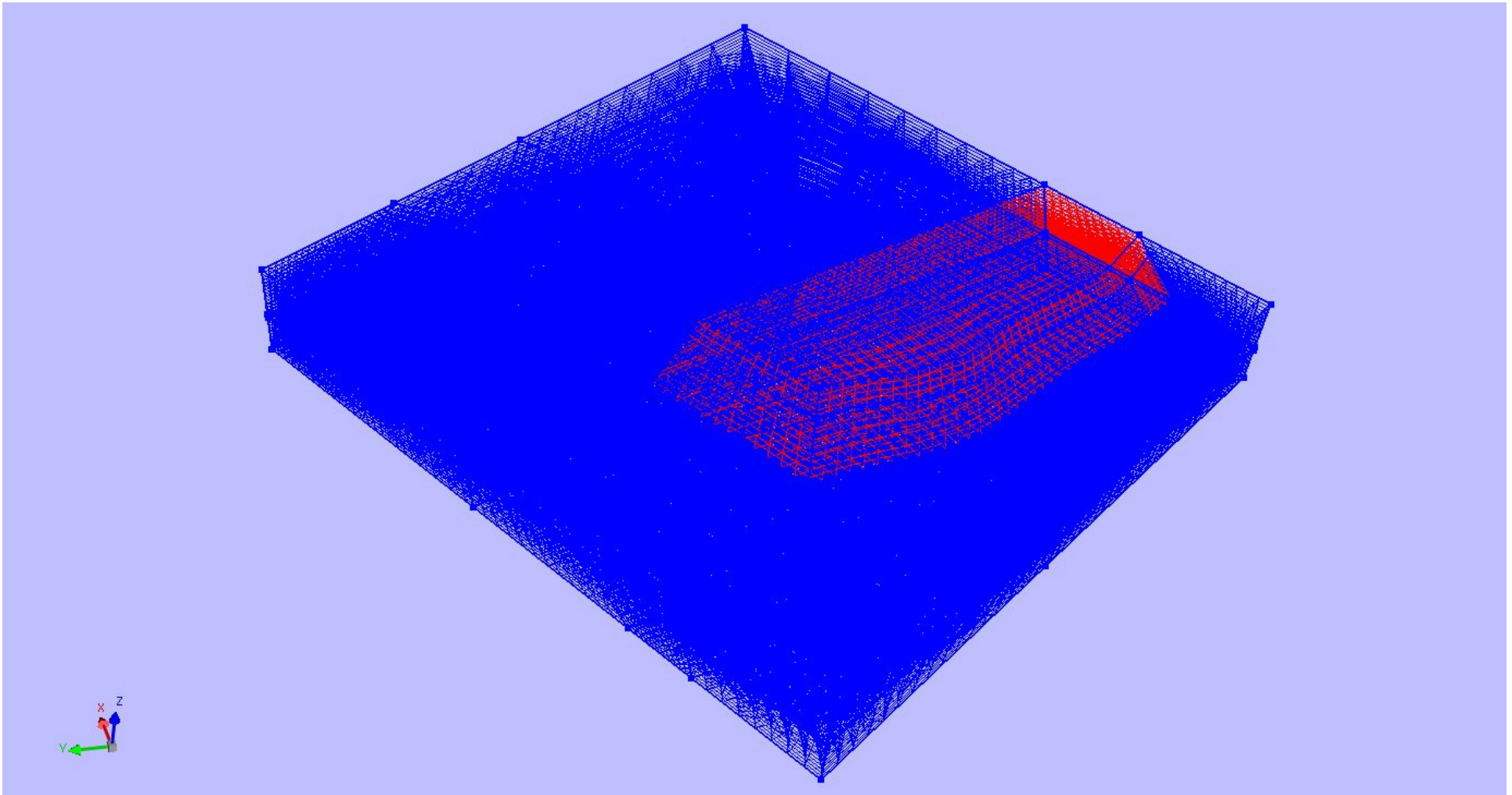

3D mapping mesh generation

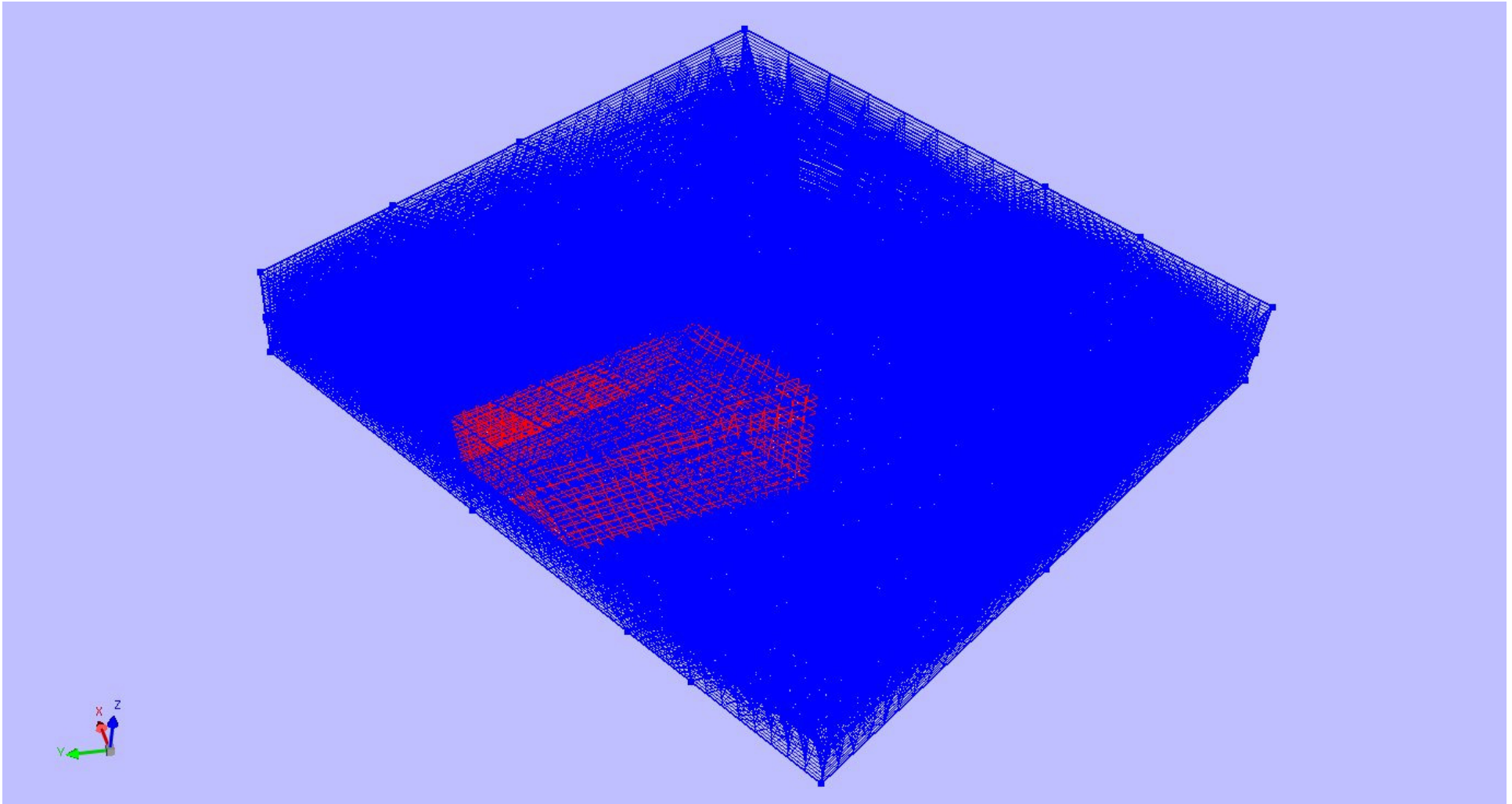

3D sweeping mesh generation

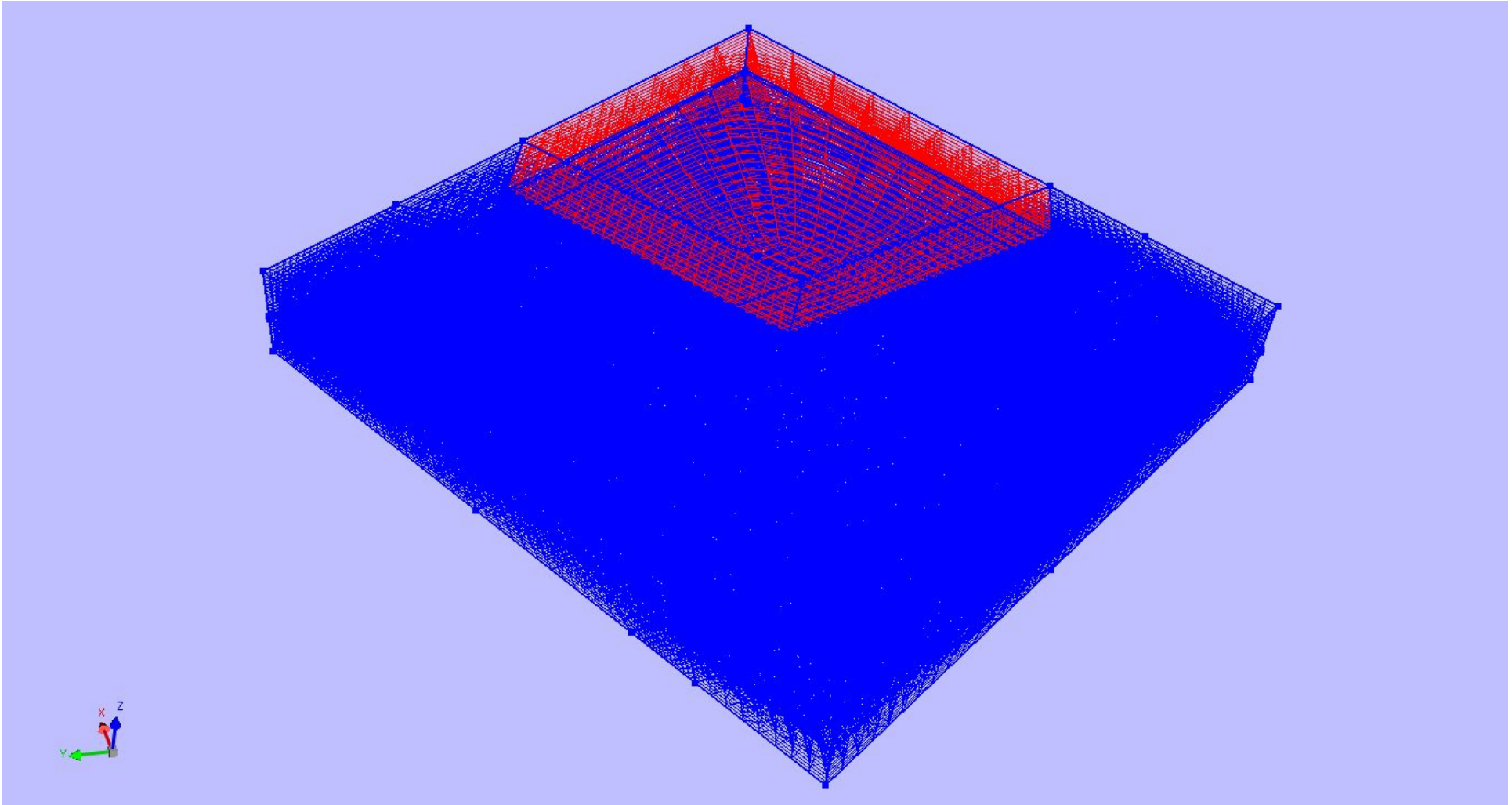

3D mapping mesh generation

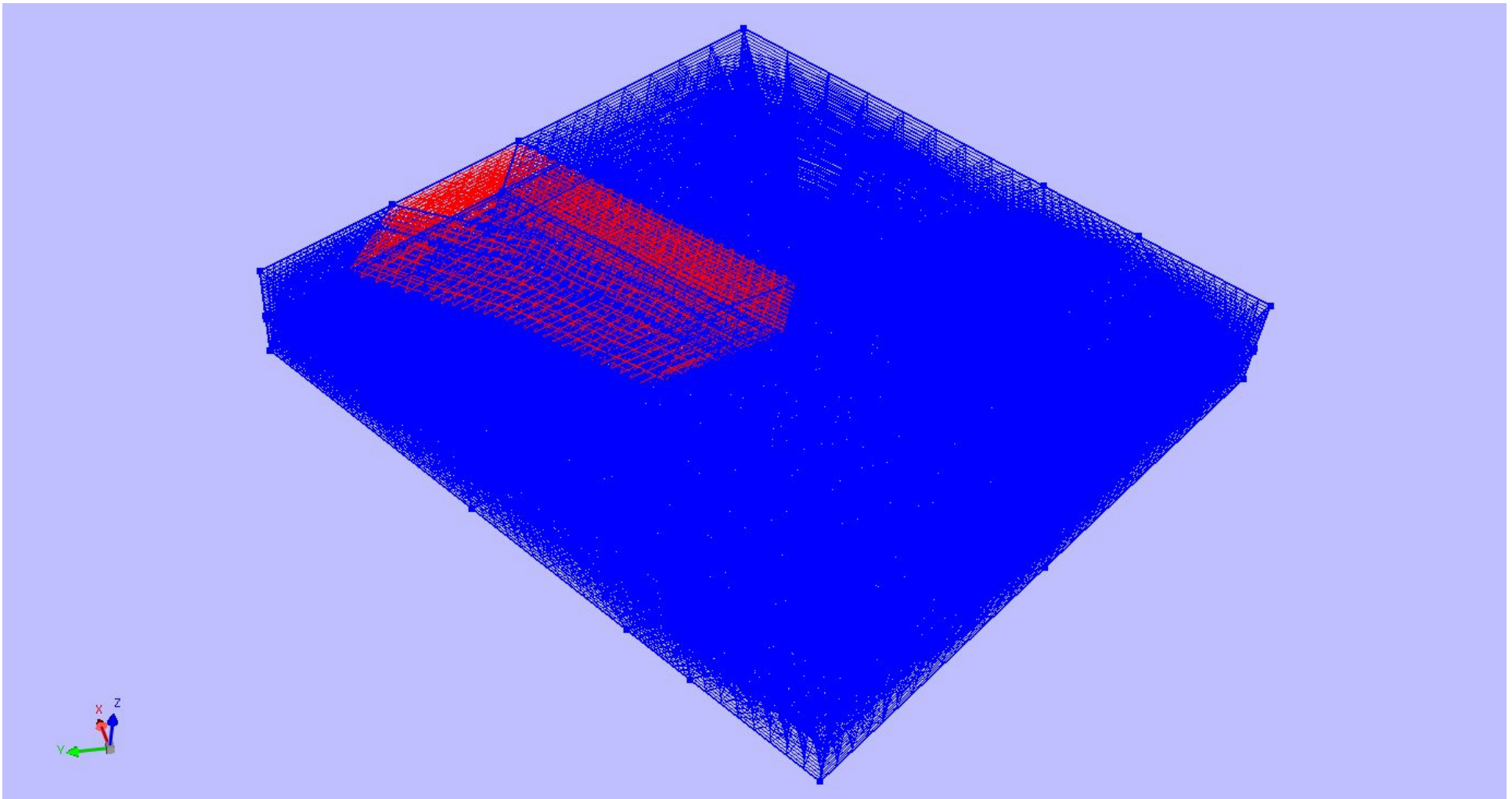

3D mapping mesh generation

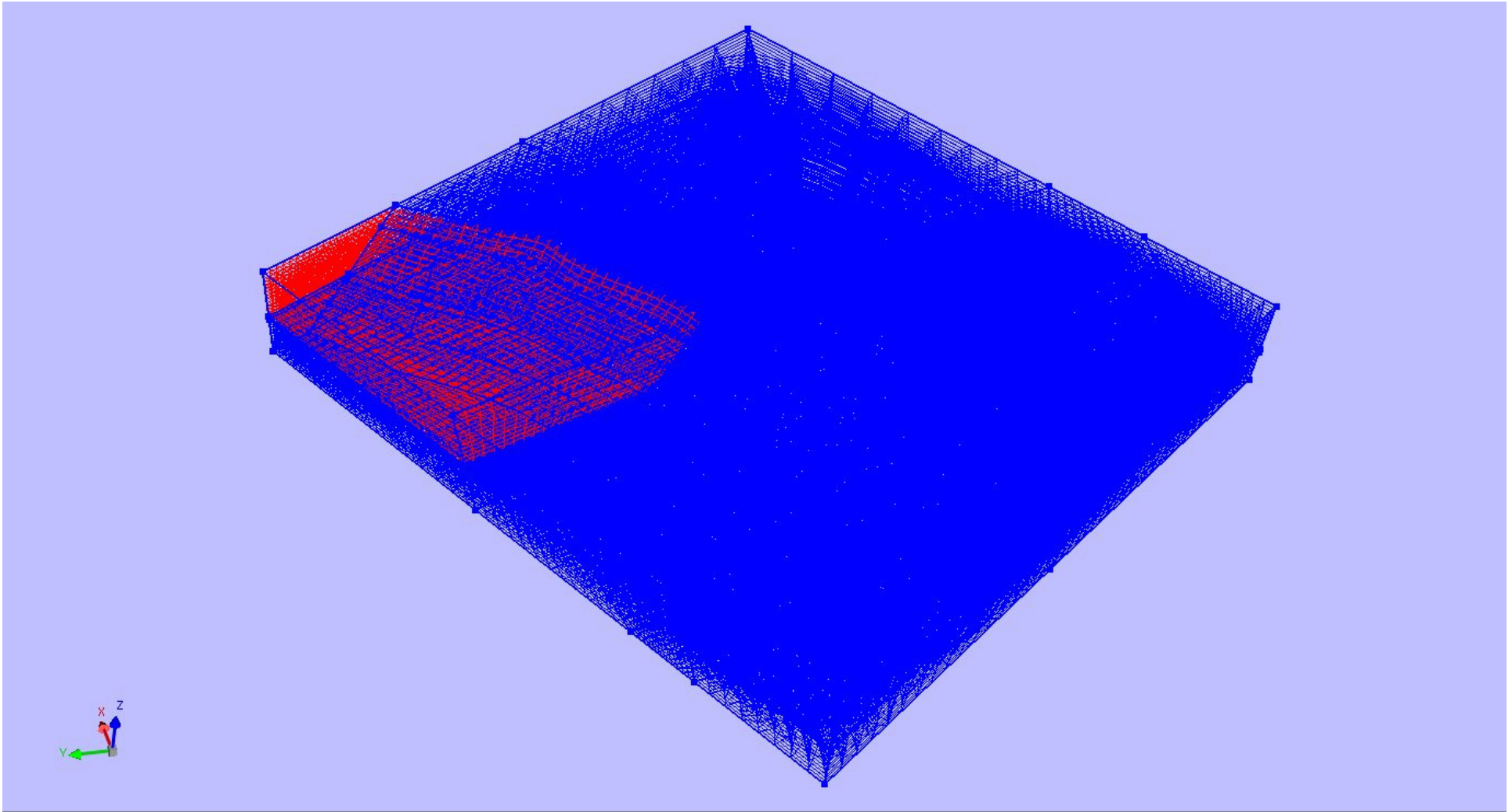

Final mesh consolidation

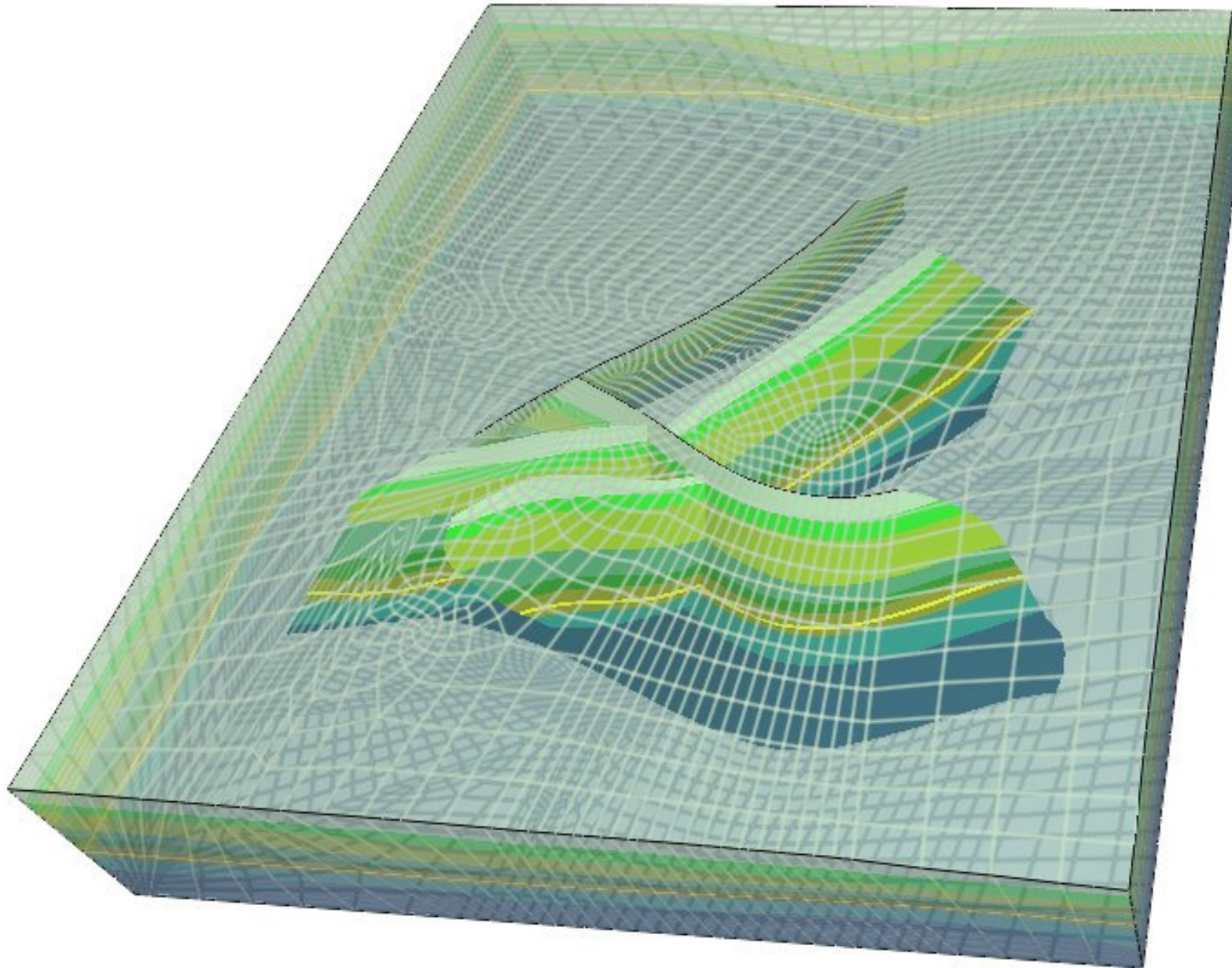

Final mesh consolidation

